

# CLI Reference Guide

## ZyWALL USG/USG

## FLEX/VPN/ATP Series

### Default Login Details

LAN Port IP Address	https://192.168.1.1
User Name	admin
Password	1234

Version 4.10–5.10 Ed. 1, 10/2021

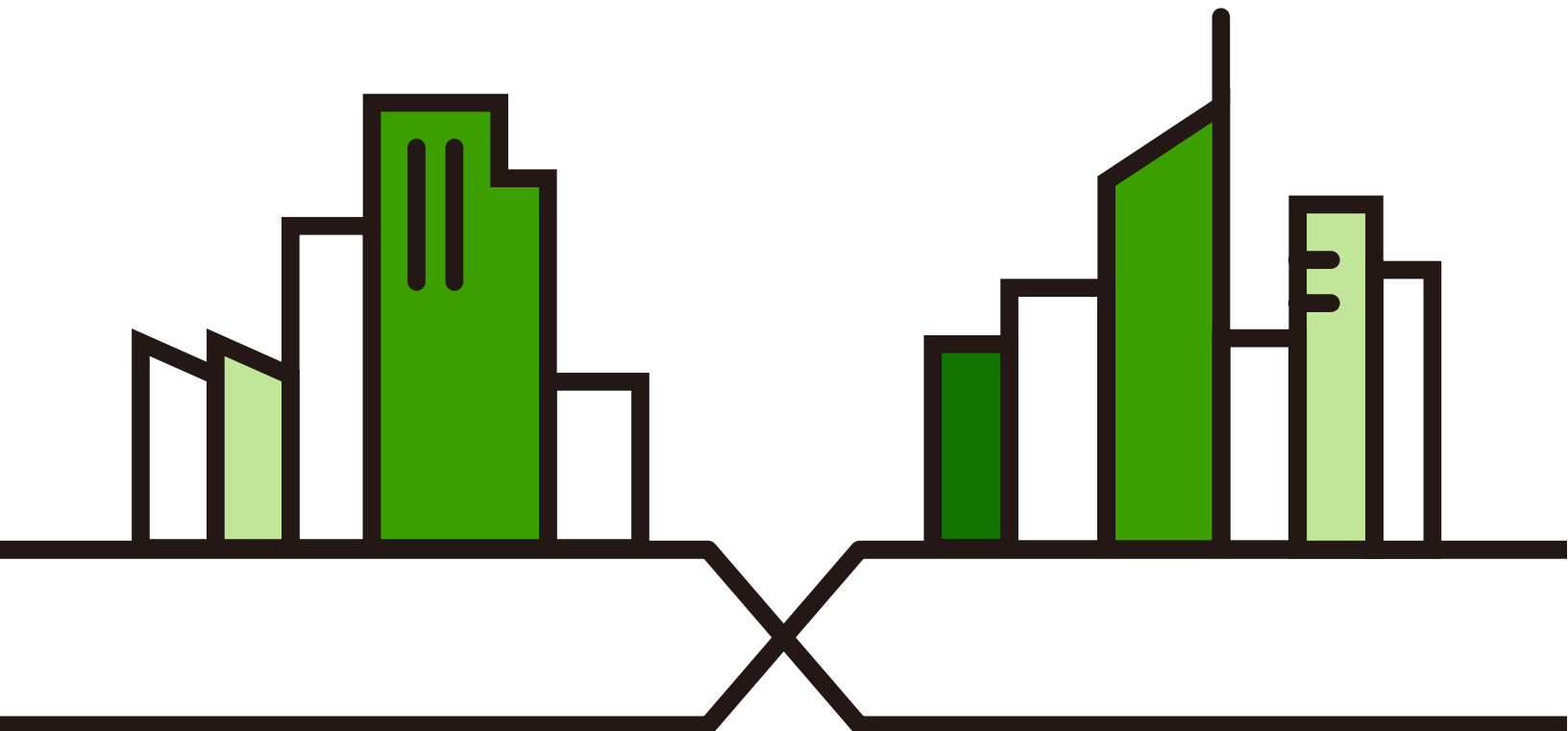

**IMPORTANT!  
READ CAREFULLY BEFORE USE.  
KEEP THIS GUIDE FOR FUTURE REFERENCE.**

This is a Reference Guide for a series of products intended for people who want to configure the Zyxel Device via Command Line Interface (CLI).

Note: The version number on the cover page refers to the latest firmware version supported by the Zyxel Device. This guide applies to ZLD version 4.10–5.00 at the time of writing.

## How To Use This Guide

- 1 Read [Chapter 1 on page 25](#) for how to access and use the CLI (Command Line Interface).
- 2 Read [Chapter 2 on page 41](#) to learn about the CLI user and privilege modes.

**Some commands or command options in this guide may not be available in your product. See your product's User's Guide for a list of supported features.**

**Do not use commands not documented in this guide. Use of undocumented commands or misconfiguration can damage the unit and possibly render it unusable.**

**Some commands are renamed between firmware versions. In cases where a command has multiple names, the Reference Guide lists each variation.**

## Related Documentation

- Quick Start Guide

The Quick Start Guide shows how to connect the Zyxel Device and access the Web Configurator.

- User's Guide

The ZyWALL USG, ATP, USG FLEX and VPN series User Guides explain how to use the Web Configurator to configure the Zyxel Device. It also shows the product feature matrix for each device. General feature differences are written in the Introduction chapter while a more detailed table is in the Product Feature appendix.

Note: It is recommended you use the Web Configurator to configure the Zyxel Device.

- More Information

Go to [support.zyxel.com](http://support.zyxel.com) to find other information on Zyxel Device.



# Contents Overview

<b>Introduction</b> .....	<b>24</b>
Command Line Interface .....	25
User and Privilege Modes .....	41
<b>Reference</b> .....	<b>43</b>
Object Reference .....	44
Status .....	46
Registration .....	52
AP Management .....	55
Built-in AP .....	65
AP Group .....	67
Wireless LAN Profiles .....	74
Rogue AP .....	95
Wireless Health .....	99
Wireless Frame Capture .....	103
Dynamic Channel Selection .....	106
Auto-Healing .....	107
LEDs .....	109
Interfaces .....	111
Trunks .....	158
Route .....	162
Routing Protocol .....	172
Zones .....	179
DDNS .....	182
Virtual Servers .....	185
HTTP Redirect .....	198
Redirect Service .....	200
ALG .....	204
UPnP .....	207
IP/MAC Binding .....	210
Layer 2 Isolation .....	212
Secure Policy .....	215
Cloud CNM .....	235
Web Authentication .....	243
Hotspot .....	254
IPSec VPN .....	269
SSL VPN .....	287
L2TP VPN .....	291

Bandwidth Management .....	299
Application Patrol .....	305
Anti-Virus .....	309
RTLS .....	317
Reputation Filter .....	319
Sandboxing .....	336
IDP Commands .....	339
Content Filtering .....	356
Anti-Spam .....	390
Collaborative Detection & Response .....	402
SSL Inspection .....	408
IP Exception .....	415
Device HA .....	417
Device Insight .....	427
User/Group .....	431
Application Object .....	441
Addresses .....	444
Services .....	453
Schedules .....	456
AAA Server .....	458
Authentication Objects .....	465
Authentication Server .....	476
Certificates .....	478
ISP Accounts .....	484
SSL Application .....	487
DHCPv6 Objects .....	490
Dynamic Guest Accounts .....	493
System .....	496
System Remote Management .....	512
File Manager .....	524
Logs .....	548
Reports and Reboot .....	555
Diagnostics and Remote Assistance .....	561
Session Timeout .....	564
Packet Flow Explore .....	565
Maintenance Tools .....	569
Miscellaneous .....	580
Managed AP Commands .....	587

---

# Table of Contents

<b>Contents Overview .....</b>	<b>3</b>
<b>Table of Contents .....</b>	<b>5</b>
<b>Part I: Introduction .....</b>	<b>24</b>
<b>Chapter 1</b>	
<b>Command Line Interface .....</b>	<b>25</b>
1.1 Overview .....	25
1.1.1 The Configuration File .....	26
1.2 Accessing the CLI .....	26
1.2.1 Console Port .....	27
1.2.2 Web Configurator Console .....	27
1.2.3 Telnet .....	29
1.2.4 SSH (Secure SHell) .....	30
1.3 How to Find Commands in this Guide .....	31
1.4 How Commands Are Explained .....	31
1.4.1 Background Information (Optional) .....	31
1.4.2 Command Input Values (Optional) .....	31
1.4.3 Command Summary .....	31
1.4.4 Command Examples (Optional) .....	31
1.4.5 Command Syntax .....	31
1.4.6 Naming Conventions .....	32
1.4.7 Changing the Password .....	32
1.4.8 Idle Timeout .....	32
1.5 CLI Modes .....	32
1.6 Shortcuts and Help .....	33
1.6.1 List of Available Commands .....	33
1.6.2 List of Sub-commands or Required User Input .....	34
1.6.3 Entering Partial Commands .....	34
1.6.4 Entering a ? in a Command .....	35
1.6.5 Command History .....	35
1.6.6 Navigation .....	35
1.6.7 Erase Current Command .....	35
1.6.8 The no Commands .....	35
1.7 Input Values .....	35
1.8 Ethernet Interfaces .....	40
1.9 Saving Configuration Changes .....	40

1.10 Logging Out .....	40
1.11 Resetting the Zyxel Device .....	40
<b>Chapter 2</b>	
<b>User and Privilege Modes .....</b>	<b>41</b>
2.1 User And Privilege Modes .....	41
<b>Part II: Reference .....</b>	<b>43</b>
<b>Chapter 3</b>	
<b>Object Reference .....</b>	<b>44</b>
3.1 Object Reference Commands .....	44
3.1.1 Object Reference Command Example .....	45
<b>Chapter 4</b>	
<b>Status .....</b>	<b>46</b>
4.1 ATP Dashboard Commands .....	50
4.2 CPU Temperature Monitor Commands .....	51
<b>Chapter 5</b>	
<b>Registration .....</b>	<b>52</b>
5.1 myZyxel Overview .....	52
5.1.1 Subscription Services Available on the Zyxel Device .....	52
5.2 Registration Commands .....	53
5.2.1 Command Examples .....	54
<b>Chapter 6</b>	
<b>AP Management .....</b>	<b>55</b>
6.1 AP Management Overview .....	55
6.2 AP Management Values .....	55
6.3 General AP Management Commands .....	56
6.3.1 AP Management Commands Example .....	60
6.4 Remote AP .....	62
6.4.1 Remote AP Notes .....	63
6.4.2 Remote AP Commands .....	64
<b>Chapter 7</b>	
<b>Built-in AP .....</b>	<b>65</b>
7.1 Built-in AP Commands .....	65
<b>Chapter 8</b>	
<b>AP Group .....</b>	<b>67</b>

---

8.1 Wireless Load Balancing Overview .....	67
8.2 AP Group Commands .....	67
8.2.1 AP Group Examples .....	71
<b>Chapter 9</b>	
<b>Wireless LAN Profiles .....</b>	<b>74</b>
9.1 Wireless LAN Profiles Overview .....	74
9.2 AP Radio & Monitor Profile Commands .....	74
9.2.1 AP Radio & Monitor Profile Commands Example .....	83
9.3 SSID Profile Commands .....	84
9.3.1 SSID Profile Example .....	87
9.4 Security Profile Commands .....	87
9.4.1 Security Profile Example .....	90
9.4.2 SSID and Security Profiles Example .....	91
9.5 MAC Filter Profile Commands .....	92
9.5.1 MAC Filter Profile Example .....	92
9.6 ZyMesh Profile Commands .....	93
<b>Chapter 10</b>	
<b>Rogue AP .....</b>	<b>95</b>
10.1 Rogue AP Detection Overview .....	95
10.2 Rogue AP Detection Commands .....	95
10.2.1 Rogue AP Detection Examples .....	96
10.3 Rogue AP Containment Overview .....	97
10.4 Rogue AP Containment Commands .....	98
10.4.1 Rogue AP Containment Example .....	98
<b>Chapter 11</b>	
<b>Wireless Health .....</b>	<b>99</b>
11.1 Wireless Health Overview .....	99
11.2 Wireless Health Commands .....	99
11.2.1 Wireless Health Radio and Station Settings .....	101
11.2.2 Wireless Health Radio and Station Actions .....	102
<b>Chapter 12</b>	
<b>Wireless Frame Capture .....</b>	<b>103</b>
12.1 Wireless Frame Capture Overview .....	103
12.2 Wireless Frame Capture Commands .....	103
12.2.1 Wireless Frame Capture Examples .....	104
12.2.2 Remote Packet Capture .....	104
<b>Chapter 13</b>	
<b>Dynamic Channel Selection.....</b>	<b>106</b>

---

13.1 DCS Overview .....	106
13.2 DCS Commands .....	106
<b>Chapter 14</b>	
<b>Auto-Healing .....</b>	<b>107</b>
14.1 Auto-Healing Overview .....	107
14.2 Auto-Healing Commands .....	107
14.2.1 Auto-Healing Examples .....	108
<b>Chapter 15</b>	
<b>LEDs .....</b>	<b>109</b>
15.1 LED Suppression Mode .....	109
15.2 LED Suppression Commands .....	109
15.2.1 LED Suppression Commands Example .....	109
15.3 LED Locator .....	110
15.4 LED Locator Commands .....	110
15.4.1 LED Locator Commands Example .....	110
<b>Chapter 16</b>	
<b>Interfaces .....</b>	<b>111</b>
16.1 Interface Overview .....	111
16.1.1 Types of Interfaces .....	111
16.1.2 Relationships Between Interfaces .....	114
16.2 Interface General Commands Summary .....	115
16.2.1 Basic Interface Properties and IP Address Commands .....	115
16.2.2 IGMP Proxy Commands .....	122
16.2.3 Proxy ARP Commands .....	123
16.2.4 DHCP Setting Commands .....	124
16.2.5 Interface Parameter Command Examples .....	129
16.2.6 RIP Commands .....	130
16.2.7 OSPF Commands .....	131
16.2.8 Connectivity Check (Ping-check) Commands .....	132
16.3 Ethernet Interface Specific Commands .....	133
16.3.1 MAC Address Setting Commands .....	133
16.3.2 Port Grouping Commands .....	134
16.4 Virtual Interface Specific Commands .....	135
16.4.1 Virtual Interface Command Examples .....	136
16.5 PPPoE/PPTP Specific Commands .....	136
16.5.1 PPPoE/PPTP Interface Command Examples .....	137
16.6 Cellular Interface Specific Commands .....	138
16.6.1 Cellular Status .....	141
16.6.2 Cellular Interface Command Examples .....	142
16.7 Tunnel Interface Specific Commands .....	143



16.7.1 Tunnel Interface Command Examples .....	145
16.8 USB Storage Specific Commands .....	145
16.8.1 Firmware Upgrade via USB Stick .....	146
16.8.2 USB Storage Commands Example .....	148
16.9 VLAN Interface Specific Commands .....	148
16.9.1 VLAN Interface Command Examples .....	149
16.10 Bridge Specific Commands .....	149
16.10.1 Bridge Interface Command Examples .....	150
16.11 LAG Commands .....	150
16.11.1 LAG Interface Command Example .....	153
16.12 VTI Commands .....	154
16.12.1 Restrictions for IPsec Virtual Tunnel Interface .....	154
16.12.2 VTI Interface Command Example .....	157
<b>Chapter 17</b>	
<b>Trunks .....</b>	<b>158</b>
17.1 Trunks Overview .....	158
17.2 Trunk Scenario Examples .....	158
17.3 Trunk Commands Input Values .....	159
17.4 Trunk Commands Summary .....	159
17.5 Trunk Command Examples .....	160
<b>Chapter 18</b>	
<b>Route .....</b>	<b>162</b>
18.1 Policy Route .....	162
18.1.1 Source Network Address Translation (SNAT) .....	162
18.2 Policy Route Commands .....	163
18.2.1 Assured Forwarding (AF) PHB for DiffServ .....	168
18.2.2 Policy Route Command Example .....	168
18.3 IP Static Route .....	169
18.4 Static Route Commands .....	170
18.4.1 Static Route Commands Examples .....	171
<b>Chapter 19</b>	
<b>Routing Protocol.....</b>	<b>172</b>
19.1 Routing Protocol Overview .....	172
19.2 Routing Protocol Commands Summary .....	172
19.2.1 RIP Commands .....	173
19.2.2 General OSPF Commands .....	173
19.2.3 OSPF Area Commands .....	174
19.2.4 Virtual Link Commands .....	174
19.2.5 Learned Routing Information Commands .....	175
19.2.6 Show IP Route Command Example .....	175

19.3 BGP (Border Gateway Protocol) .....	175
19.3.1 BGP Commands .....	177
<b>Chapter 20</b>	
<b>Zones.....</b>	<b>179</b>
20.1 Zones Overview .....	179
20.2 Zone Commands Summary .....	180
20.2.1 Zone Command Examples .....	181
<b>Chapter 21</b>	
<b>DDNS .....</b>	<b>182</b>
21.1 DDNS Overview .....	182
21.2 DDNS Commands Summary .....	183
21.3 DDNS Commands Example .....	184
<b>Chapter 22</b>	
<b>Virtual Servers.....</b>	<b>185</b>
22.1 Virtual Server Overview .....	185
22.1.1 1:1 NAT and Many 1:1 NAT .....	185
22.2 Virtual Server Commands Summary .....	185
22.2.1 Virtual Server Command Examples .....	187
22.2.2 Tutorial - How to Allow Public Access to a Server .....	188
22.3 Virtual Server Load Balancing .....	189
22.3.1 Load Balancing Example 1 .....	189
22.3.2 Load Balancing Example 2 .....	190
22.3.3 Virtual Server Load Balancing Process .....	191
22.3.4 Load Balancing Rules .....	192
22.3.5 Virtual Server Load Balancing Algorithms .....	193
22.3.6 Virtual Server Load Balancing Commands .....	194
<b>Chapter 23</b>	
<b>HTTP Redirect .....</b>	<b>198</b>
23.1 HTTP Redirect Overview .....	198
23.1.1 Web Proxy Server .....	198
23.2 HTTP Redirect Commands .....	198
23.2.1 HTTP Redirect Command Examples .....	199
<b>Chapter 24</b>	
<b>Redirect Service .....</b>	<b>200</b>
24.1 HTTP Redirect .....	200
24.2 SMTP Redirect .....	200
24.3 Redirect Commands .....	201
24.3.1 Redirect Command Example .....	203

<b>Chapter 25</b>	
<b>ALG</b> .....	<b>204</b>
25.1 ALG Introduction .....	204
25.2 ALG Commands .....	205
25.3 ALG Commands Example .....	206
<b>Chapter 26</b>	
<b>UPnP</b> .....	<b>207</b>
26.1 UPnP and NAT-PMP Overview .....	207
26.2 UPnP and NAT-PMP Commands .....	207
26.3 UPnP & NAT-PMP Commands Example .....	208
<b>Chapter 27</b>	
<b>IP/MAC Binding</b> .....	<b>210</b>
27.1 IP/MAC Binding Overview .....	210
27.2 IP/MAC Binding Commands .....	210
27.3 IP/MAC Binding Commands Example .....	211
<b>Chapter 28</b>	
<b>Layer 2 Isolation</b> .....	<b>212</b>
28.1 Layer 2 Isolation Overview .....	212
28.2 Layer 2 Isolation Commands .....	213
28.2.1 Layer 2 Isolation White List Sub-Commands .....	213
28.3 Layer 2 Isolation Commands Example .....	214
<b>Chapter 29</b>	
<b>Secure Policy</b> .....	<b>215</b>
29.1 Secure Policy Overview .....	215
29.2 Secure Policy Commands .....	216
29.2.1 Secure Policy Sub-Commands .....	219
29.2.2 Security Services Multiple Profiles .....	221
29.2.3 Secure Policy Command Examples .....	222
29.3 Session Limit Commands .....	226
29.4 ADP Commands Overview .....	228
29.4.1 ADP Command Input Values .....	229
29.4.2 ADP Activation Commands .....	229
29.4.3 ADP Global Profile Commands .....	229
29.4.4 ADP Zone-to-Zone Rule Commands .....	230
29.4.5 ADP Add/Edit Profile Sub Commands .....	230
29.4.6 ADP Flood Detection Whitelist Commands .....	233
<b>Chapter 30</b>	
<b>Cloud CNM</b> .....	<b>235</b>

30.1 Cloud CNM Overview .....	235
30.2 Cloud CNM SecuManager .....	235
30.2.1 Introduction to XMPP .....	236
30.2.2 Cloud CNM SecuManager Commands .....	237
30.2.3 Cloud CNM SecuManager Command Example .....	240
30.3 <b>Cloud CNM</b> SecuReporter .....	240
30.3.1 <b>Cloud CNM</b> SecuReporter Commands .....	240
30.3.2 <b>Cloud CNM</b> SecuReporter Commands Example .....	242
<b>Chapter 31</b>	
<b>Web Authentication.....</b>	<b>243</b>
31.1 Web Authentication Overview .....	243
31.1.1 User Two-Factor Authentication .....	243
31.1.2 802.1X Single Sign-On .....	244
31.1.3 Summary of User Authentication Methods .....	244
31.2 Web Authentication Commands .....	245
31.2.1 web-auth login setting Sub-commands .....	247
31.2.2 web-auth policy Sub-commands .....	248
31.2.3 Facebook Wi-Fi Commands .....	250
31.3 SSO Overview .....	250
31.3.1 SSO Configuration Commands .....	251
31.3.2 SSO Show Commands .....	251
31.3.3 Command Setup Sequence Example .....	252
31.3.4 Two-Factor Web Authentication Command Example .....	252
<b>Chapter 32</b>	
<b>Hotspot.....</b>	<b>254</b>
32.1 Hotspot Overview .....	254
32.2 Billing Overview .....	254
32.3 Billing Commands .....	254
32.3.1 Billing Profile Sub-commands .....	256
32.3.2 Billing Command Example .....	256
32.3.3 Payment Service .....	258
32.4 Printer Manager Overview .....	261
32.5 Printer-manager Commands .....	261
32.5.1 Printer-manager Printer Sub-commands .....	262
32.5.2 Printer-manager Command Example .....	262
32.6 Free Time Overview .....	263
32.7 Free-Time Commands .....	263
32.8 Free-Time Commands Example .....	264
32.9 IPnP Overview .....	264
32.10 IPnP Commands .....	264
32.11 IPnP Commands Example .....	265

32.12 Walled Garden Overview .....	265
32.13 Walled Garden Commands .....	265
32.13.1 walled-garden rule Sub-commands .....	266
32.13.2 walled-garden domain-ip rule Sub-commands .....	267
32.13.3 Walled Garden Command Example .....	267
32.14 Advertisement Overview .....	268
32.15 Advertisement Commands .....	268
32.15.1 Advertisement Command Example .....	268
<b>Chapter 33</b>	
<b>IPSec VPN .....</b>	<b>269</b>
33.1 IPSec VPN Overview .....	269
33.2 IPSec VPN Commands Summary .....	270
33.2.1 IPv4 IKEv1 SA Commands .....	271
33.2.2 IPv4 IPSec SA Commands (except Manual Keys) .....	273
33.2.3 IPv4 IPSec SA Commands (for Manual Keys) .....	278
33.2.4 VPN Concentrator Commands .....	279
33.2.5 VPN Configuration Provisioning Commands .....	279
33.2.6 SA Monitor Commands .....	281
33.2.7 IPv4 IKEv2 SA Commands .....	281
33.2.8 IPv6 IKEv2 SA Commands .....	283
33.2.9 IPv6 IPSec SA Commands .....	284
33.2.10 IPv6 VPN Concentrator Commands .....	286
<b>Chapter 34</b>	
<b>SSL VPN .....</b>	<b>287</b>
34.1 SSL Access Policy .....	287
34.1.1 SSL Application Objects .....	287
34.1.2 SSL Access Policy Limitations .....	287
34.2 SSL VPN Commands .....	287
34.2.1 SSL VPN Commands .....	288
34.2.2 Setting an SSL VPN Rule Tutorial .....	289
<b>Chapter 35</b>	
<b>L2TP VPN .....</b>	<b>291</b>
35.1 L2TP VPN Overview .....	291
35.2 IPSec Configuration .....	291
35.2.1 Using the Default L2TP VPN Connection .....	292
35.3 LAN Policy Route .....	292
35.4 WAN Policy Route .....	292
35.5 L2TP VPN Commands .....	293
35.5.1 L2TP VPN Commands .....	294
35.5.2 L2TP Account Commands .....	295

35.6 L2TP VPN Examples .....	296
35.6.1 Configuring the Default L2TP VPN Gateway Example .....	296
35.6.2 Configuring the Default L2TP VPN Connection Example .....	296
35.6.3 Configuring the L2TP VPN Settings Example .....	297
35.6.4 Configuring the LAN Policy Route for L2TP Example .....	297
35.6.5 Configuring the WAN Policy Route for L2TP Example .....	298
<b>Chapter 36</b>	
<b>Bandwidth Management .....</b>	<b>299</b>
36.1 Bandwidth Management Overview .....	299
36.1.1 BWM Type .....	299
36.2 Bandwidth Management Commands .....	299
36.2.1 Bandwidth Sub-Commands .....	300
36.3 Bandwidth Management Commands Examples .....	303
<b>Chapter 37</b>	
<b>Application Patrol .....</b>	<b>305</b>
37.1 Application Patrol Overview .....	305
37.2 Application Patrol Commands Summary .....	305
37.2.1 Application Patrol Commands .....	306
<b>Chapter 38</b>	
<b>Anti-Virus.....</b>	<b>309</b>
38.1 Anti-Virus Overview .....	309
38.2 Anti-Virus Commands .....	309
38.2.1 General Anti-Virus Commands .....	310
38.2.2 Anti-Virus Profile .....	311
38.2.3 White and Black Lists .....	312
38.2.4 Signature Search Anti-Virus Command .....	314
38.3 Update Anti-Virus Signatures .....	315
38.3.1 Update Signature Examples .....	315
38.4 Anti-Virus Statistics .....	316
38.4.1 Anti-Virus Statistics Example .....	316
<b>Chapter 39</b>	
<b>RTLS.....</b>	<b>317</b>
39.1 RTLS Overview .....	317
39.1.1 RTLS Configuration Commands .....	318
39.1.2 RTLS Configuration Examples .....	318
<b>Chapter 40</b>	
<b>Reputation Filter .....</b>	<b>319</b>
40.1 Overview .....	319

40.1.1 Signature Database Priority .....	320
40.2 IP Reputation Commands .....	320
40.2.1 Update IP Reputation Signatures .....	322
40.2.2 IP Reputation Statistics .....	322
40.2.3 IP Reputation External Black List .....	322
40.3 URL Threat Filter Commands .....	324
40.3.1 URL Threat Filter Profile Commands .....	326
40.3.2 URL Threat Filter External Black List .....	327
40.3.3 Update URL Threat Filter Signatures .....	329
40.3.4 Update Signature Examples .....	330
40.3.5 URL Threat Filter Statistics .....	330
40.3.6 URL Threat Filter Statistics Example .....	331
40.4 DNS Threat Filter Commands .....	333
<b>Chapter 41</b>	
<b>Sandboxing .....</b>	<b>336</b>
41.1 Sandboxing Overview .....	336
41.2 Sandbox Commands .....	336
41.2.1 Sandbox Command Examples .....	338
<b>Chapter 42</b>	
<b>IDP Commands .....</b>	<b>339</b>
42.1 Overview .....	339
42.2 General IDP Commands .....	340
42.2.1 IDP Activation .....	340
42.3 IDP Profile Commands .....	342
42.3.1 Global Profile Commands .....	342
42.3.2 Editing/Creating IDP Signature Profiles .....	343
42.3.3 Editing Rate Based Signatures Profiles .....	343
42.3.4 Signature Search .....	345
42.4 IDP Custom Signatures .....	346
42.4.1 Custom Signature Examples .....	347
42.5 Update IDP Signatures .....	350
42.5.1 Update Signature Examples .....	351
42.6 IDP Statistics .....	351
42.6.1 IDP Statistics Example .....	353
42.7 IDP White List .....	353
42.8 IDP Packet Capture .....	354
42.8.1 IDP Packet Capture Example .....	355
<b>Chapter 43</b>	
<b>Content Filtering .....</b>	<b>356</b>
43.1 Content Filtering Overview .....	356

43.1.1 Web Content Filter .....	356
43.1.2 DNS Content Filter .....	356
43.2 External Web Filtering Service .....	357
43.3 Content Filter Command Input Values .....	358
43.4 Web Content Filter .....	360
43.4.1 General Web Content Filter Commands .....	360
43.4.2 Web Content Filter Profile Commands .....	362
43.4.3 Web Content Filtering Statistics .....	366
43.4.4 Web Content Filtering Statistics Example .....	367
43.5 DNS Content Filter .....	367
43.5.1 DNS Content Filter Commands .....	367
43.5.2 DNS Content Filter Profile Commands .....	369
43.5.3 DNS Content Filtering Statistics .....	369
43.6 Web Content Filtering Example .....	370
43.7 Content Filter Category Definitions .....	372
43.8 Web Content Filter Example .....	385
43.9 DNS Content Filter Example .....	386
<b>Chapter 44</b>	
<b>Anti-Spam.....</b>	<b>390</b>
44.1 Anti-Spam Overview .....	390
44.2 Anti-Spam Commands .....	390
44.2.1 Anti-Spam Profile Rules .....	390
44.2.2 White and Black Lists .....	395
44.2.3 DNSBL Anti-Spam Commands .....	397
44.3 Anti-Spam Statistics .....	400
44.3.1 Anti-Spam Statistics Example .....	401
<b>Chapter 45</b>	
<b>Collaborative Detection &amp; Response.....</b>	<b>402</b>
45.1 Overview .....	402
45.1.1 CDR Example Scenario .....	402
45.2 Before You Begin .....	403
45.3 CDR Commands .....	405
45.3.1 CDR General Commands .....	405
45.3.2 CDR Show Commands .....	407
45.3.3 Update CDR Signatures .....	407
<b>Chapter 46</b>	
<b>SSL Inspection.....</b>	<b>408</b>
46.1 SSL Inspection Overview .....	408
46.2 SSL Inspection Commands Summary .....	408
46.2.1 SSL Inspection General Settings .....	409



46.2.2 SSL Inspection Exclusion Commands .....	409
46.2.3 SSL Inspection Profile Settings .....	410
46.2.4 SSL Inspection Certificate Cache .....	412
46.2.5 SSL Inspection Certificate Update .....	412
46.2.6 SSL Inspection Statistics .....	413
46.2.7 SSL Inspection Command Examples .....	413
<b>Chapter 47</b>	
<b>IP Exception.....</b>	<b>415</b>
47.1 IP Exception Overview .....	415
47.2 IP Exception Commands .....	415
<b>Chapter 48</b>	
<b>Device HA.....</b>	<b>417</b>
48.1 Device HA Overview .....	417
48.1.1 Before You Begin .....	418
48.1.2 Device HA and Device HA Pro .....	418
48.2 General Device HA Commands .....	419
48.3 Active-Passive Mode Device HA .....	419
48.4 Active-Passive Mode Device HA Commands .....	420
48.4.1 Active-Passive Mode Device HA Commands .....	420
48.4.2 Active-Passive Mode Device HA Command Example .....	422
48.5 Device HA Pro .....	422
48.5.1 Deploying Device HA Pro .....	422
48.5.2 Device HA Pro Commands .....	423
48.5.3 Device HA2 Command Example .....	425
<b>Chapter 49</b>	
<b>Device Insight.....</b>	<b>427</b>
49.1 Device Insight Overview .....	427
49.1.1 Device Insight Commands .....	429
<b>Chapter 50</b>	
<b>User/Group .....</b>	<b>431</b>
50.1 User Account Overview .....	431
50.1.1 User Types .....	431
50.2 User/Group Commands Summary .....	432
50.2.1 User Commands .....	432
50.2.2 User Group Commands .....	434
50.2.3 User Setting Commands .....	434
50.2.4 MAC Auth Commands .....	436
50.2.5 Additional User Commands .....	437

---

<b>Chapter 51</b>	
<b>Application Object</b> .....	<b>441</b>
51.1 Application Object Commands Summary .....	441
51.1.1 Application Object Commands .....	441
51.1.2 Application Object Group Commands .....	442
<b>Chapter 52</b>	
<b>Addresses</b> .....	<b>444</b>
52.1 Address Overview .....	444
52.2 Address Commands Summary .....	444
52.2.1 Address Object Commands .....	445
52.2.2 Address Group Commands .....	449
52.2.3 FQDN Object .....	450
52.2.4 Geo IP .....	451
52.2.5 FQDN / Geo IP Commands .....	451
52.2.6 Geo IP Command Examples .....	452
<b>Chapter 53</b>	
<b>Services</b> .....	<b>453</b>
53.1 Services Overview .....	453
53.2 Services Commands Summary .....	453
53.2.1 Service Object Commands .....	453
53.2.2 Service Group Commands .....	455
<b>Chapter 54</b>	
<b>Schedules</b> .....	<b>456</b>
54.1 Schedule Overview .....	456
54.2 Schedule Commands Summary .....	456
54.2.1 Schedule Command Examples .....	457
<b>Chapter 55</b>	
<b>AAA Server</b> .....	<b>458</b>
55.1 AAA Server Overview .....	458
55.2 Authentication Server Command Summary .....	458
55.2.1 ad-server Commands .....	458
55.2.2 ldap-server Commands .....	459
55.2.3 radius-server Commands .....	460
55.2.4 radius-server Command Example .....	460
55.2.5 aaa group server ad Commands .....	460
55.2.6 aaa group server ldap Commands .....	462
55.2.7 aaa group server radius Commands .....	463
55.2.8 aaa group server Command Example .....	464

---

<b>Chapter 56</b>	
<b>Authentication Objects .....</b>	<b>465</b>
56.1 Authentication Objects Overview .....	465
56.2 aaa authentication Commands .....	465
56.2.1 aaa authentication Command Example .....	466
56.3 test aaa Command .....	466
56.3.1 Test a User Account Command Example .....	466
56.4 VPN/Admin Two-Factor Authentication .....	467
56.4.1 Two-Factor Authentication Methods .....	467
56.4.2 Two-Factor Authentication with SMS/Email .....	468
56.4.3 SMS/Email Configuration .....	469
56.4.4 Two-Factor Authentication with Google Authenticator .....	469
56.5 Two-Factor Authentication Commands .....	471
56.5.1 Two-Factor Authentication VPN Access .....	471
56.5.2 VPN Access Two-Factor Command Example .....	473
56.5.3 Admin Access .....	473
56.5.4 Admin Access Two-Factor Command Example .....	474
<b>Chapter 57</b>	
<b>Authentication Server .....</b>	<b>476</b>
57.1 Authentication Server Overview .....	476
57.2 Authentication Server Commands .....	476
57.2.1 Authentication Server Command Examples .....	477
<b>Chapter 58</b>	
<b>Certificates .....</b>	<b>478</b>
58.1 Certificates Overview .....	478
58.2 Certificate Commands .....	478
58.3 Certificates Commands Input Values .....	478
58.4 Certificates Commands Summary .....	480
58.5 Certificates Commands Examples .....	483
<b>Chapter 59</b>	
<b>ISP Accounts .....</b>	<b>484</b>
59.1 ISP Accounts Overview .....	484
59.1.1 PPPoE and PPTP Account Commands .....	484
59.1.2 Cellular Account Commands .....	485
<b>Chapter 60</b>	
<b>SSL Application .....</b>	<b>487</b>
60.1 SSL Application Overview .....	487
60.1.1 SSL Application Object Commands .....	487
60.1.2 SSL Application Command Examples .....	489

<b>Chapter 61</b>	
<b>DHCPv6 Objects.....</b>	<b>490</b>
61.1 DHCPv6 Object Commands Summary .....	490
61.1.1 DHCPv6 Object Commands .....	490
61.1.2 DHCPv6 Object Command Examples .....	491
<b>Chapter 62</b>	
<b>Dynamic Guest Accounts.....</b>	<b>493</b>
62.1 Dynamic Guest Accounts Overview .....	493
62.2 Dynamic-guest Commands .....	493
62.2.1 dynamic-guest Sub-commands .....	494
62.2.2 Dynamic-guest Command Example .....	495
<b>Chapter 63</b>	
<b>System.....</b>	<b>496</b>
63.1 System Overview .....	496
63.2 Customizing the WWW Login Page .....	496
63.3 Host Name Commands .....	498
63.4 Time and Date .....	498
63.4.1 Date/Time Commands .....	499
63.5 Console Port Speed .....	500
63.6 DNS Overview .....	500
63.6.1 Domain Zone Forwarder .....	500
63.6.2 DNS Commands .....	501
63.6.3 DNS Command Examples .....	503
63.7 Authentication Server Overview .....	503
63.7.1 Authentication Server Commands .....	504
63.7.2 Authentication Server Command Examples .....	505
63.8 Notification .....	505
63.8.1 Mail Server Commands .....	505
63.8.2 SMS Service Commands .....	506
63.8.3 Response Message Commands .....	508
63.9 Language Commands .....	509
63.10 IPv6 Commands .....	509
63.11 ZON Overview .....	509
63.11.1 LLDP .....	510
63.11.2 ZON Commands .....	510
63.11.3 ZON Examples .....	510
63.12 Fast Forwarding .....	511
63.12.1 Fast Forwarding Technical Overview .....	511
63.12.2 Fast Forwarding Commands .....	511

---

<b>Chapter 64</b>	
<b>System Remote Management</b> .....	<b>512</b>
64.1 Remote Management Overview .....	512
64.1.1 Remote Management Limitations .....	512
64.1.2 System Timeout .....	512
64.2 Common System Command Input Values .....	513
64.3 HTTP/HTTPS Commands .....	513
64.3.1 HTTP/HTTPS Command Examples .....	515
64.4 SSH .....	516
64.4.1 SSH Implementation on the Zyxel Device .....	516
64.4.2 Requirements for Using SSH .....	516
64.4.3 SSH Commands .....	516
64.4.4 SSH Command Examples .....	517
64.5 Telnet .....	517
64.6 Telnet Commands .....	517
64.6.1 Telnet Commands Examples .....	518
64.7 Configuring FTP .....	518
64.7.1 FTP Commands .....	519
64.7.2 FTP Commands Examples .....	519
64.8 SNMP .....	520
64.8.1 Supported MIBs .....	520
64.8.2 SNMP Traps .....	520
64.8.3 SNMP Commands .....	521
64.8.4 SNMP Commands Examples .....	522
64.9 ICMP Filter .....	523
<b>Chapter 65</b>	
<b>File Manager</b> .....	<b>524</b>
65.1 File Directories .....	524
65.2 Configuration Files and Shell Scripts Overview .....	524
65.2.1 Comments in Configuration Files or Shell Scripts .....	525
65.2.2 Errors in Configuration Files or Shell Scripts .....	526
65.2.3 Zyxel Device Configuration File Details .....	527
65.2.4 Configuration File Flow at Restart .....	527
65.3 File Manager Commands Input Values .....	528
65.4 File Manager Commands Summary .....	528
65.5 File Manager Dual Firmware Commands .....	529
65.6 File Manager Command Examples .....	530
65.7 FTP File Transfer .....	531
65.7.1 Command Line FTP File Upload .....	531
65.7.2 Command Line FTP Configuration File Upload Example .....	531
65.7.3 Command Line FTP File Download .....	532
65.7.4 Command Line FTP Configuration File Download Example .....	532

65.8 Cloud Helper Commands .....	533
65.8.1 Cloud Helper Command Examples .....	536
65.9 Zyxel Device File Usage at Startup .....	537
65.10 Notification of a Damaged Recovery Image or Firmware .....	538
65.11 Restoring the Recovery Image .....	539
65.12 Restoring the Firmware .....	541
65.13 Restoring the Default System Database .....	543
65.13.1 Using the atkz -u Debug Command .....	545
<b>Chapter 66</b>	
<b>Logs .....</b>	<b>548</b>
66.1 Log Commands Summary .....	548
66.1.1 Log Entries Commands .....	549
66.1.2 System Log Commands .....	549
66.1.3 Debug Log Commands .....	550
66.1.4 E-mail Profile Commands .....	552
66.1.5 Console Port Logging Commands .....	553
<b>Chapter 67</b>	
<b>Reports and Reboot .....</b>	<b>555</b>
67.1 Report Commands Summary .....	555
67.1.1 Report Commands .....	555
67.1.2 Report Command Examples .....	556
67.1.3 Session Commands .....	556
67.1.4 Packet Size Statistics Commands .....	557
67.2 Email Daily Report Commands .....	557
67.2.1 Email Daily Report Example .....	558
67.3 Reboot .....	560
<b>Chapter 68</b>	
<b>Diagnostics and Remote Assistance .....</b>	<b>561</b>
68.1 Diagnostics .....	561
68.2 Diagnosis Commands .....	561
68.3 Diagnosis Commands Example .....	562
68.4 Remote Assistance .....	562
68.5 Remote Assistance Commands .....	563
<b>Chapter 69</b>	
<b>Session Timeout .....</b>	<b>564</b>
<b>Chapter 70</b>	
<b>Packet Flow Explore .....</b>	<b>565</b>
70.1 Packet Flow Explore .....	565
70.2 Packet Flow Explore Commands .....	565

---

70.3 Packet Flow Explore Commands Example .....	566
<b>Chapter 71</b>	
<b>Maintenance Tools .....</b>	<b>569</b>
71.1 Maintenance Command Examples .....	572
71.1.1 Packet Capture Command Example .....	574
71.2 Scheduled Reboot .....	576
71.2.1 High Availability Reboot Process .....	577
71.3 Configuration File Backup .....	578
<b>Chapter 72</b>	
<b>Miscellaneous .....</b>	<b>580</b>
72.1 SDWan OnCloud .....	580
72.2 Watchdog Timer .....	580
72.2.1 Hardware Watchdog Timer .....	580
72.2.2 Software Watchdog Timer .....	580
72.2.3 Application Watchdog .....	581
72.3 Conserve Memory .....	584
72.3.1 Conserve Memory Settings .....	584
72.3.2 Conserve Memory Commands .....	584
72.3.3 Conserve Memory Example .....	585
72.4 GUI Visibility .....	586
<b>Chapter 73</b>	
<b>Managed AP Commands .....</b>	<b>587</b>
73.1 Managed Series AP Commands Overview .....	587
73.2 Accessing the AP CLI .....	587
73.3 CAPWAP Client Commands .....	587
73.3.1 CAPWAP Client Commands Example .....	588
73.4 DNS Server Commands .....	590
73.4.1 DNS Server Commands Example .....	590
73.4.2 DNS Server Commands and DHCP .....	590
<b>List of Commands (Alphabetical) .....</b>	<b>592</b>

---

# PART I

## Introduction

---



# CHAPTER 1

# Command Line Interface

This chapter describes how to access and use the CLI (Command Line Interface).

## 1.1 Overview

Zyxel Device refers to these models as outlined below:

Devices on firmware 4.1–4.6

- ZyWALL
  - ZyWALL 110
  - ZyWALL 310
  - ZyWALL 1100
- ZyWALL USG (Unified Security Gateway)
  - USG40
  - USG40W
  - USG60
  - USG60W
  - USG40
  - USG110
  - USG210
  - USG310
  - USG1100
  - USG110
  - USG1900
  - USG2200
  - USG2200-VPN

Devices on firmware 4.1–5.1

- ZyWALL USG (Unified Security Gateway)
  - USG20-VPN
  - USG20W-VPN
- ZyWALL USG FLEX
  - USG FLEX 100
  - USG FLEX 100W
  - USG FLEX 200
  - USG FLEX 500
  - USG FLEX 700

- ZyWALL ATP (Advanced Threat Protection)
  - ATP100
  - ATP100W
  - ATP200
  - ATP500
  - ATP700
  - ATP800
  
- ZyWALL VPN
  - VPN50
  - VPN100
  - VPN300
  - VPN1000

If you have problems with your Zyxel Device, customer support may request that you issue some of these commands to assist them in troubleshooting.

**Use of undocumented commands or misconfiguration can damage the Zyxel Device and possibly render it unusable.**

### 1.1.1 The Configuration File

When you configure the Zyxel Device using either the CLI (Command Line Interface) or the web configurator, the settings are saved as a series of commands in a configuration file on the Zyxel Device. You can store more than one configuration file on the Zyxel Device. However, only one configuration file is used at a time.

You can perform the following with a configuration file:

- Back up Zyxel Device configuration once the Zyxel Device is set up to work in your network.
- Restore Zyxel Device configuration.
- Save and edit a configuration file and upload it to multiple Zyxel Devices (of the same model) in your network to have the same settings.

Note: You may also edit a configuration file using a text editor.

## 1.2 Accessing the CLI

You can access the CLI using a terminal emulation program on a computer connected to the console port, from the web configurator or access the Zyxel Device using Telnet or SSH (Secure Shell).

Note: The Zyxel Device might force you to log out of your session if re-authentication time, lease time, or idle timeout is reached. See [Chapter 49 on page 427](#) for more information about these settings.

## 1.2.1 Console Port

The default settings for the console port are as follows.

Table 1 Managing the Zyxel Device: Console Port

SETTING	VALUE
Speed	115200 bps
Data Bits	8
Parity	None
Stop Bit	1
Flow Control	Off

When you turn on your Zyxel Device, it performs several internal tests as well as line initialization. You can view the initialization information using the console port.

- Garbled text displays if your terminal emulation program's speed is set lower than the Zyxel Device's.
- No text displays if the speed is set higher than the Zyxel Device's.
- If changing your terminal emulation program's speed does not get anything to display, restart the Zyxel Device.
- If restarting the Zyxel Device does not get anything to display, contact your local customer support.

**Figure 1** Console Port Power-on Display

```
U-Boot 2011.03 (Development build, svnversion: u-boot:424M, exec:exported)
(Build time: Aug 28 2013 - 14:19:07)

BootModule Version: V1.01 | Aug 28 2013 14:19:07
DRAM: Size = 1024 Mbytes

Press any key to enter debug mode within 3 seconds.
```

After the initialization, the login screen displays.

**Figure 2** Login Screen

```
Welcome to USG60W

Username:
```

Enter the user name and password at the prompts.

Note: The default login username is **admin** and password is **1234**. The username and password are case-sensitive.

## 1.2.2 Web Configurator Console

Note: Before you can access the CLI through the web configurator, make sure your computer supports the Java Runtime Environment. You will be prompted to download and install the Java plug-in if it is not already installed.

When you access the CLI using the web console, your computer establishes a SSH (Secure Shell) connection to the Zyxel Device. Follow the steps below to access the web console.

- 1 Log into the web configurator.
- 2 Click the **Console** icon  in the top-right corner of the web configurator screen.
- 3 If the Java plug-in is already installed, skip to step 4.  
Otherwise, you will be prompted to install the Java plug-in. If the prompt does not display and the screen remains gray, you have to download the setup program.
- 4 The web console starts. This might take a few seconds. One or more security screens may display. Click **Yes** or **Always**.

**Figure 3** Web Console: Security Warnings



Finally, the **User Name** screen appears.

**Figure 4** Web Console: User Name

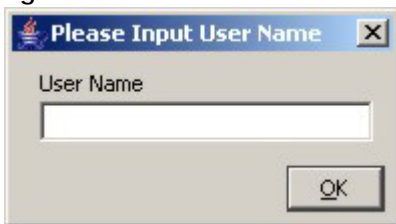

- 5 Enter the user name you want to use to log in to the console. The console begins to connect to the Zyxel Device.

Note: The default login username is **admin**. It is case-sensitive.

Figure 5 Web Console: Connecting

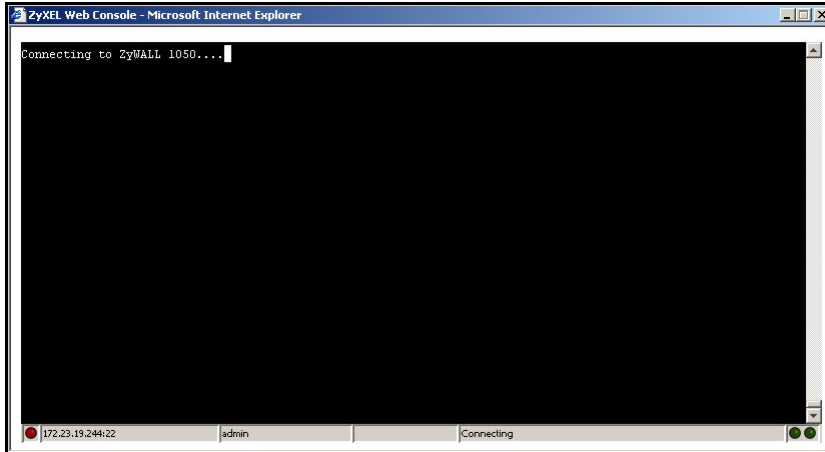

Then, the **Password** screen appears.

Figure 6 Web Console: Password



- 6 Enter the password for the user name you specified earlier, and click **OK**. If you enter the password incorrectly, you get an error message, and you may have to close the console window and open it again. If you enter the password correctly, the console screen appears.

Figure 7 Web Console

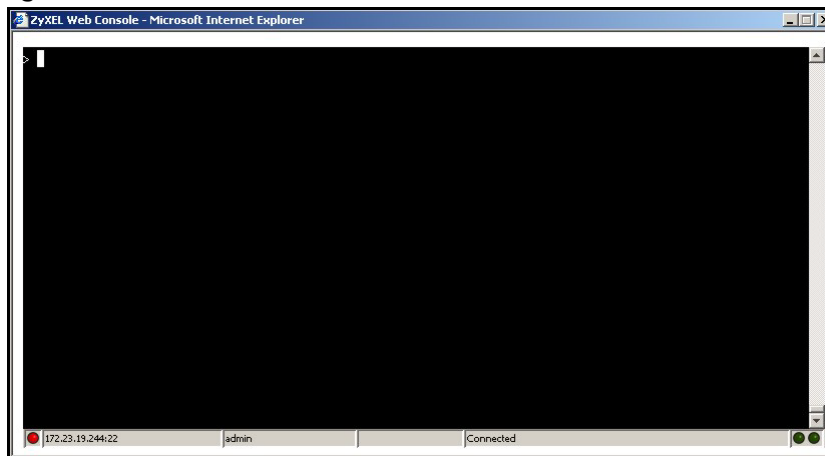

- 7 To use most commands in this User's Guide, enter `configure terminal`. The prompt should change to `Router (config) #`.

## 1.2.3 Telnet

Use the following steps to Telnet into your Zyxel Device.

- 1 Using the Web Configurator, enable and configure Telnet at **System > TELNET**.
- 2 Ensure that the Telnet protocol is allowed from your computer's zone to the Zyxel Device. By default, add **TELNET** to the default service group at **Object > Service > Service Group > Default\_Allow\_WAN\_To\_ZyWALL**.
- 3 In Windows, click **Start** (usually in the bottom left corner) and **Run**. Then type `telnet` and the Zyxel Device's IP address. For example, enter `telnet 192.168.1.1` (the default management IP address).
- 4 Click **OK**. A login screen displays. Enter the user name and password at the prompts.

Note: The default login username is **admin** and password is **1234**. The username and password are case-sensitive.

## 1.2.4 SSH (Secure SHell)

You can use an SSH client program to access the CLI. The following figure shows an example using a text-based SSH client program. Refer to the documentation that comes with your SSH program for information on using it.

Before connecting, do the following:

- Using the Web Configurator, enable SSH at **System > SSH**.
- Ensure that the SSH protocol is allowed from your computer's zone to the Zyxel Device. By default, add **SSH** to the service group **Default\_Allow\_WAN\_To\_ZyWALL** at **Object > Service > Service Group**. This group defines which services are allowed in the default **WAN\_to\_Device** security policy.

Note: The default login username is **admin** and password is **1234**. The username and password are case-sensitive.

**Figure 8** SSH Login Example

```
C:\>ssh2 admin@192.168.1.1
Host key not found from database.
Key fingerprint:
xolor-takel-fipef-zevit-visom-gydog-vetan-bisol-lysob-cuvun-muxex
You can get a public key's fingerprint by running
% ssh-keygen -F publickey.pub
on the keyfile.
Are you sure you want to continue connecting (yes/no)? yes

Host key saved to C:/Documents and Settings/user/Application Data/SSH/
hostkeys/
ey_22_192.168.1.1.pub
host key for 192.168.1.1, accepted by user Tue Aug 09 2005 07:38:28
admin's password:
Authentication successful.
```

## 1.3 How to Find Commands in this Guide

You can simply look for the feature chapter to find commands. In addition, you can use the [List of Commands \(Alphabetical\)](#) at the end of the guide. This section lists the commands in alphabetical order that they appear in this guide.

If you are looking at the CLI Reference Guide electronically, you might have additional options (for example, bookmarks or **Find...**) as well.

## 1.4 How Commands Are Explained

Each chapter explains the commands for one keyword. The chapters are divided into the following sections.

### 1.4.1 Background Information (Optional)

Note: See the User's Guide for background information about most features.

This section provides background information about features that you cannot configure in the web configurator. In addition, this section identifies related commands in other chapters.

### 1.4.2 Command Input Values (Optional)

This section lists common input values for the commands for the feature in one or more tables

### 1.4.3 Command Summary

This section lists the commands for the feature in one or more tables.

### 1.4.4 Command Examples (Optional)

This section contains any examples for the commands in this feature.

### 1.4.5 Command Syntax

The following conventions are used in this User's Guide.

- A command or keyword in *courier new* must be entered literally as shown. Do not abbreviate.
- Values that you need to provide are in *italics*.
- Required fields that have multiple choices are enclosed in curly brackets { }.
- A range of numbers is enclosed in angle brackets <>.
- Optional fields are enclosed in square brackets [ ] .
- The | symbol means OR.

For example, look at the following command to create a TCP/UDP service object.

```
service-object object-name {tcp | udp} {eq <1..65535> | range <1..65535> <1..65535>}
```

- 1 Enter `service-object` exactly as it appears.
- 2 Enter the name of the object where you see `object-name`.
- 3 Enter `tcp` or `udp`, depending on the service object you want to create.
- 4 Finally, do one of the following.
  - Enter `eq` exactly as it appears, followed by a number between 1 and 65535.
  - Enter `range` exactly as it appears, followed by two numbers between 1 and 65535.

## 1.4.6 Naming Conventions

The ATP and USG devices may have different names for the same service, but the commands for both devices are the same. The command names will be used to refer to these services throughout this reference guide. A list of naming differences are in the next table.

Table 2 Naming differences between USG and ATP devices

COMMAND NAME	USG SERIES NAME	USG FLEX SERIES NAME	ATP SERIES NAME
anti-virus	Anti-Virus	Anti-Malware	Anti-Malware
anti-spam	Anti-Spam	Email Security	Email Security
threat-website	N/A	URL Threat Filter	URL Threat Filter

## 1.4.7 Changing the Password

It is highly recommended that you change the password for accessing the Zyxel Device. See [Section 50.2 on page 432](#) for the appropriate commands.

## 1.4.8 Idle Timeout

See [Section 50.2.1 on page 432](#) for commands on changing the default logout time when no activity is recorded.

## 1.5 CLI Modes

You run CLI commands in one of several modes.

After you log into the Zyxel Device, you will see this prompt `Router>` in **User** mode.

Type `enable` and you will see this prompt `Router#` in **Privilege** mode.

Type `configure terminal` and you will see this prompt `Router (config)#` in **Configuration** mode.



This is a summary of the modes.

Table 3 CLI Modes

	USER	PRIVILEGE	CONFIGURATION	SUB-COMMAND
What <b>Guest</b> users can do	Unable to access	Unable to access	Unable to access	Unable to access
What <b>User</b> users can do	<ul style="list-style-type: none"> <li>Look at (but not run) available commands</li> </ul>	Unable to access	Unable to access	Unable to access
What <b>Limited-Admin</b> users can do	<ul style="list-style-type: none"> <li>Look at system information (like <b>Status</b> screen)</li> <li>Run basic diagnostics</li> </ul>	<ul style="list-style-type: none"> <li>Look at system information (like <b>Status</b> screen)</li> <li>Run basic diagnostics</li> </ul>	Unable to access	Unable to access
What <b>Admin</b> users can do	<ul style="list-style-type: none"> <li>Look at system information (like <b>Status</b> screen)</li> <li>Run basic diagnostics</li> </ul>	<ul style="list-style-type: none"> <li>Look at system information (like <b>Status</b> screen)</li> <li>Run basic diagnostics</li> </ul>	<ul style="list-style-type: none"> <li>Configure simple features (such as an address object)</li> <li>Create or remove complex parts (such as an interface)</li> </ul>	<ul style="list-style-type: none"> <li>Configure complex parts (such as an interface) in the Zyxel Device</li> </ul>
How you enter it	Log in to the Zyxel Device	Type <b>enable</b> in <b>User</b> mode	Type <b>configure terminal</b> in <b>User</b> or <b>Privilege</b> mode	Type the command used to create the specific part in <b>Configuration</b> mode
What the prompt looks like	Router>	Router#	Router (config) #	(varies by part) Router (zone) # Router (config-if-ge) # ...
How you exit it	Type <b>exit</b>	Type <b>disable</b>	Type <b>exit</b>	Type <b>exit</b>

See [Chapter 49 on page 427](#) for more information about the user types. **User** users can only log in, look at (but not run) the available commands in **User** mode, and log out. **Limited-Admin** users can look at the configuration in the web configurator and CLI, and they can run basic diagnostics in the CLI. **Admin** users can configure the Zyxel Device in the web configurator or CLI.

At the time of writing, there is not much difference between **User** and **Privilege** mode for admin users. This is reserved for future use.

## 1.6 Shortcuts and Help

### 1.6.1 List of Available Commands

A list of valid commands can be found by typing ? or [TAB] at the command prompt. To view a list of available commands within a command group, enter <command> ? or <command> [TAB].

**Figure 9** Help: Available Commands Example 1

```

Router> ?
<cr>
apply
atse
clear
configure
----- [Snip] -----
shutdown
telnet
test
traceroute
write
Router>

```

**Figure 10** Help: Available Command Example 2

```

Router> show ?
<wlan ap interface>
aaa
access-page
account
ad-server
address-object
----- [Snip] -----
wlan
workspace
zone
Router> show

```

## 1.6.2 List of Sub-commands or Required User Input

To view detailed help information for a command, enter `<command> <sub command> ?`.

**Figure 11** Help: Sub-command Information Example

```

Router(config)# ip telnet server ?
;
<cr>
port
rule
|
Router(config)# ip telnet server

```

**Figure 12** Help: Required User Input Example

```

Router(config)# ip telnet server port ?
<1..65535>
Router(config)# ip telnet server port

```

## 1.6.3 Entering Partial Commands

The CLI does not accept partial or incomplete commands. You may enter a unique part of a command and press [TAB] to have the Zyxel Device automatically display the full command.

For example, if you enter **config** and press [TAB], the full command of **configure** automatically displays.

If you enter a partial command that is not unique and press [TAB], the Zyxel Device displays a list of commands that start with the partial command.

**Figure 13** Non-Unique Partial Command Example

```
Router# c [TAB]
clear      configure copy
Router# co [TAB]
configure copy
```

## 1.6.4 Entering a ? in a Command

Typing a ? (question mark) usually displays help information. However, some commands allow you to input a ?, for example as part of a string. Press [CTRL+V] on your keyboard to enter a ? without the Zyxel Device treating it as a help query.

## 1.6.5 Command History

The Zyxel Device keeps a list of commands you have entered for the current CLI session. You can use any commands in the history again by pressing the up (↑) or down (↓) arrow key to scroll through the previously used commands and press [ENTER].

## 1.6.6 Navigation

Press [CTRL]+A to move the cursor to the beginning of the line. Press [CTRL]+E to move the cursor to the end of the line.

## 1.6.7 Erase Current Command

Press [CTRL]+U to erase whatever you have currently typed at the prompt (before pressing [ENTER]).

## 1.6.8 The no Commands

When entering the no commands described in this document, you may not need to type the whole command. For example, with the "[no] mss <536..1452>" command, you use "mss 536" to specify the MSS value. But to disable the MSS setting, you only need to type "no mss" instead of "no mss 536".

## 1.7 Input Values

You can use the ? or [TAB] to get more information about the next input value that is required for a command. In some cases, the next input value is a string whose length and allowable characters may

not be displayed in the screen. For example, in the following example, the next input value is a string called <description>.

```
Router# configure terminal
Router(config)# interface ge1
Router(config-if-ge)# description
<description>
```

When you use the example above, note that Zyxel Device USG 200 and below models use a name such as wan1, wan2, opt, lan1, ext-wlan, or dmz.

The following table provides more information about input values like <description>.

Table 4 Input-Value Formats for Strings in CLI Commands

TAG	# VALUES	LEGAL VALUES
*	1	*
<i>all</i>	--	ALL
<i>authentication key</i>	Used in IPSec SA	
	32-40 16-20	"0x" or "0X" + 32-40 hexadecimal values alphanumeric or ; ~!@#\$%^&*()_+\\{\}'':,./<>=-
	Used in MD5 authentication keys for RIP/OSPF and text authentication key for RIP	
	0-16	alphanumeric or _-
	Used in text authentication keys for OSPF	
	0-8	alphanumeric or _-
<i>certificate name</i>	1-31	alphanumeric or ;~!@#\$%^&()_+[\]{}',.-
<i>community string</i>	0-63	alphanumeric or .- first character: alphanumeric or -
<i>connection_id</i>	1+	alphanumeric or -_:
<i>contact</i>	1-61	alphanumeric, spaces, or '()+,/:=?;!*#@\$_%-.
<i>country code</i>	0 or 2	alphanumeric
<i>custom signature file name</i>	0-30	alphanumeric or _-. first character: letter
<i>description</i>	Used in keyword criteria for log entries	
	1-64	alphanumeric, spaces, or '()+,/:=?;!*#@\$_%-.
	Used in other commands	
	1-61	alphanumeric, spaces, or '()+,/:=?;!*#@\$_%-
<i>distinguished name</i>	1-511	alphanumeric, spaces, or .@=, _-

Table 4 Input-Value Formats for Strings in CLI Commands (continued)

TAG	# VALUES	LEGAL VALUES
<i>domain name</i>	Used in content filtering	
	0+	lower-case letters, numbers, or .-
	Used in ip dns server	
	0-247	alphanumeric or .- first character: alphanumeric or -
	Used in domainname, ip dhcp , and ip domain	
	0-254	alphanumeric or ._- first character: alphanumeric or -
<i>email</i>	1-63	alphanumeric or .@_-
<i>e-mail</i>	1-64	alphanumeric or .@_-
<i>encryption key</i>	16-64	"0x" or "0X" + 16-64 hexadecimal values
	8-32	alphanumeric or ;\ `~!@#\$\$%^&*()_+\\{'':.,/<>=-
<i>file name</i>	0-31	alphanumeric or _-
<i>filter extension</i>	1-256	alphanumeric, spaces, or '()+,/:=?;!*#@\$%_-.
<i>fqdn</i>	Used in ip dns server	
	0-252	alphanumeric or .- first character: alphanumeric or -
	Used in ip ddns, time server, device HA, VPN, certificates, and interface ping check	
	0-254	alphanumeric or .- first character: alphanumeric or -
<i>full file name</i>	0-256	alphanumeric or _/.-
<i>hostname</i>	Used in hostname command	
	0-63	alphanumeric or .-_ first character: alphanumeric or -
	Used in other commands	
	0-252	alphanumeric or .- first character: alphanumeric or -
<i>import configuration file</i>	1-26+" .conf"	alphanumeric or ;`~!@#\$\$%^&*()_+[]{}',.- add ".conf" at the end
<i>import shell script</i>	1-26+" .zysh"	alphanumeric or ;`~!@#\$\$%^&*()_+[]{}',.- add ".zysh" at the end
<i>initial string</i>	1-64	alphanumeric, spaces, or '()+,/:=!*#@\$%_-.&
<i>isp account password</i>	0-63	alphanumeric or `~!@#\$\$%^&*()_\-+={ }\;:'<, >./
<i>isp account username</i>	0-30	alphanumeric or -_@\$. /

Table 4 Input-Value Formats for Strings in CLI Commands (continued)

TAG	# VALUES	LEGAL VALUES
<i>ipv6_addr</i>		An IPv6 address. The 128-bit IPv6 address is written as eight 16-bit hexadecimal blocks separated by colons (:). This is an example IPv6 address 2001:0db8:1a2b:0015:0000:0000:1a2f:0000.  IPv6 addresses can be abbreviated in two ways:  Leading zeros in a block can be omitted. So 2001:0db8:1a2b:0015:0000:0000:1a2f:0000 can be written as 2001:db8:1a2b:15:0:0:1a2f:0.  Any number of consecutive blocks of zeros can be replaced by a double colon. A double colon can only appear once in an IPv6 address. So 2001:0db8:0000:0000:1a2f:0000:0000:0015 can be written as 2001:0db8::1a2f:0000:0000:0015, 2001:0db8:0000:0000:1a2f::0015, 2001:db8::1a2f:0:0:15 or 2001:db8:0:0:1a2f::15.
<i>key length</i>	--	512, 768, 1024, 1536, 2048, 4096
<i>license key</i>	25	"S-" + 6 upper-case letters or numbers + "-" + 16 upper-case letters or numbers
<i>mac address</i>	--	aa:bb:cc:dd:ee:ff (hexadecimal)
<i>mail server fqdn</i>		lower-case letters, numbers, or -.
<i>name</i>	1-31	alphanumeric or _-
<i>notification message</i>	1-81	alphanumeric, spaces, or '()+,/:=?;!*#@\$_%-
<i>password: less than 15 chars</i>	1-15	alphanumeric or `~!@#\$\$%^&*()_-\+={ }\;:'<,>./
<i>password: less than 8 chars</i>	1-8	alphanumeric or ;/?:@&+=\$\.-_!~*'()%,#\$
<i>password</i>	Used in user and ip ddns	
	1-63	alphanumeric or `~!@#\$\$%^&*()_-\+={ }\;:'<,>./
	Used in e-mail log profile SMTP authentication	
	1-63	alphanumeric or `~!@#\$\$%^&*()_-\+={ }\;:'<>./
	Used in device HA synchronization	
	1-63	alphanumeric or ~#%^*_-={:},.
<i>password</i>	Used in registration	
	6-20	alphanumeric or .@_-
<i>phone number</i>	1-20	numbers or , +
<i>preshared key</i>	16-64	"0x" or "0X" + 16-64 hexadecimal values alphanumeric or ; `~!@#\$\$%^&*()_+\{ }'<,>=-
<i>profile name</i>	0-30	alphanumeric or _- first character: letters or _-
<i>proto name</i>	1-16	lower-case letters, numbers, or -
<i>protocol name</i>	0-30	alphanumeric or _- first character: letters or _-
<i>quoted string less than 127 chars</i>	1-255	alphanumeric, spaces, or ;/?:@&+=\$\.-_!~*'()% ,
<i>quoted string less than 63 chars</i>	1-63	alphanumeric, spaces, or ;/?:@&+=\$\.-_!~*'()%

Table 4 Input-Value Formats for Strings in CLI Commands (continued)

TAG	# VALUES	LEGAL VALUES
<i>quoted string</i>	0+	alphanumeric, spaces, or punctuation marks enclosed in double quotation marks (") must put a backslash (\) before double quotation marks that are part of input value itself
<i>service name</i>	0-63	alphanumeric or -_@\$. /
<i>spi</i>	2-8	hexadecimal
<i>string less than 15 chars</i>	1-15	alphanumeric or -_
<i>string: less than 63 chars</i>	1-63	alphanumeric or `~!@#\$\$%^&*()_-=+{  \; : '<, > . /
<i>string</i>	1+	alphanumeric or -_@
<i>subject</i>	1-61	alphanumeric, spaces, or '()+,./:=?;!*#@\$_% -
<i>system type</i>	0-2	hexadecimal
<i>timezone [-+]hh</i>	--	-12 through +12 (with or without "+")
<i>url</i>	1-511	alphanumeric or '()+,./:=?;!*#@\$_% -
<i>url</i>	Used in content filtering redirect	
	"http://" + "https://" +	alphanumeric or ;/?:@&=+\$\._!~*'()%, starts with "http://" or "https://" may contain one pound sign (#)
	Used in other content filtering commands	
	"http://" +	alphanumeric or ;/?:@&=+\$\._!~*'()%, starts with "http://" may contain one pound sign (#)
<i>user name</i>	Used in VPN extended authentication	
	1-31	alphanumeric or _-
	Used in other commands	
	0-30	alphanumeric or _- first character: letters or _-
<i>username</i>	6-20	alphanumeric or .@_- registration
<i>user name</i>	1+	alphanumeric or -_. logging commands
<i>user@domainname</i>	1-80	alphanumeric or .@_-
<i>vrrp group name: less than 15 chars</i>	1-15	alphanumeric or _-
<i>week-day sequence, i.e. 1=first, 2=second</i>	1	1-4
<i>xauth method</i>	1-31	alphanumeric or _-
<i>xauth password</i>	1-31	alphanumeric or ; `~!@#\$\$%^&*()_+ \{ } ' : , . / < > = -
<i>mac address</i>	0-12 (even number)	hexadecimal for example: aa aabbcc aabbccddeeff

## 1.8 Ethernet Interfaces

How you specify an Ethernet interface depends on the Zyxel Device model.

- For some Zyxel Device models, use `gex`,  $x = 1-N$ , where  $N$  equals the highest numbered Ethernet interface for your Zyxel Device model.
- For other Zyxel Device models use a name such as `wan1`, `wan2`, `opt`, `lan1`, or `dmz`.

## 1.9 Saving Configuration Changes

Use the `write` command to save the current configuration to the Zyxel Device.

Note: Always save the changes before you log out after each management session. All unsaved changes will be lost after the system restarts.

## 1.10 Logging Out

Enter the `exit` or `end` command in configure mode to go to privilege mode.

Enter the `exit` command in user mode or privilege mode to log out of the CLI.

## 1.11 Resetting the Zyxel Device

If you cannot access the Zyxel Device by any method, try restarting it by turning the power off and then on again. If you still cannot access the Zyxel Device by any method or you forget the administrator password(s), you can reset the Zyxel Device to its factory-default settings. Any configuration files or shell scripts that you saved on the Zyxel Device should still be available afterwards.

Use the following command to reset the Zyxel Device to its factory-default settings. This overwrites the settings in the `startup-config.conf` file with the settings in the `system-default.conf` file.

Note: This procedure removes the current configuration. Note that there is a space after `apply` in the command.

**Figure 14** Resetting the Zyxel Device

```
Router> apply /conf/system-default.conf
```



# CHAPTER 2

## User and Privilege Modes

This chapter describes how to use these two modes.

### 2.1 User And Privilege Modes

This is the mode you are in when you first log into the CLI. (Do not confuse 'user mode' with types of user accounts the Zyxel Device uses. See [Chapter 49 on page 427](#) for more information about the user types. 'User' type accounts can only run 'exit' in this mode. However, they may need to log into the device in order to be authenticated for 'user-aware' policies, for example a firewall rule that a particular user is exempt from or a VPN tunnel that only certain people may use.)

Type 'enable' to go to 'privilege mode'. No password is required. All commands can be run from here except those marked with an asterisk. Many of these commands are for trouble-shooting purposes, for example debug commands. Customer support may ask you to run some of these commands and send the results if you need assistance troubleshooting your device.

For admin logins, all commands are visible in 'user mode' but not all can be run there. The following table displays which commands can be run in 'user mode'. All commands can be run in 'privilege mode'.

Type `ezmode activate` if you have a simple network environment with one ISP for Internet access for example. You'll enter **Easy Mode** every time you log in to the Zyxel Device using the Web Configurator. Objects created in **Easy Mode** begin with **EZ\_**

Type `ezmode deactivate` if you have a complex network environment with two ISPs for Internet access for example. You'll enter **Expert Mode** every time you log in to the Zyxel Device using the Web Configurator. Some **EZ\_** objects cannot be edited in **Expert Mode**.

**The `psm` commands are for Zyxel's internal manufacturing process.**

Table 5 User (U) and Privilege (P) Mode Commands

COMMAND	MODE	DESCRIPTION
apply	P	Applies a configuration file.
atse	U/P	Displays the seed code
clear	U/P	Clears system or debug logs or DHCP binding.
configure	U/P	Use 'configure terminal' to enter configuration mode.
copy	P	Copies configuration files.
debug (*)	U/P	For support personnel only! The device needs to have the debug flag enabled.
delete	P	Deletes configuration files.
details	P	Performs diagnostic commands.

Table 5 User (U) and Privilege (P) Mode Commands (continued)

COMMAND	MODE	DESCRIPTION
diag	P	Provided for support personnel to collect internal system information. It is not recommended that you use these.
diag-info	P	Has the Zyxel Device create a new diagnostic file.
dir	P	Lists files in a directory.
disable	U/P	Goes from privilege mode to user mode
enable	U/P	Goes from user mode to privilege mode
exit	U/P	Goes to a previous mode or logs out.
interface	U/P	Dials or disconnects an interface.
no packet-trace	U/P	Turns off packet tracing.
nslookup	U/P	Resolves an IP address to a host name and vice-versa.
packet-trace	U/P	Performs a packet trace.
ping	U/P	Pings an IP address or host name.
ping6	U/P	Pings an IPv6 address or a host name.
psm	U/P	Goes to psm (product support module) mode for setting product parameters. Only use psm commands if your customer support Engineer asks you to during troubleshooting.  Note: These commands are for Zyxel's internal manufacturing process.
reboot	P	Restarts the device.
release	P	Releases DHCP information from an interface.
rename	P	Renames a configuration file.
renew	P	Renews DHCP information for an interface.
run	P	Runs a script.
setenv	U/P	Turns stop-on-error on (terminates booting if an error is found in a configuration file) or off (ignores configuration file errors and continues booting).
show	U/P	Displays command statistics. See the associated command chapter in this guide.
shutdown	P	Writes all d data to disk and stops the system processes. It does not turn off the power.
telnet	U/P	Establishes a connection to the TCP port number 23 of the specified host name or IP address.
test aaa	U/P	Tests whether the specified user name can be successfully authenticated by an external authentication server.
traceroute	P	Traces the route to the specified host name or IP address.
traceroute6	P	Traces the route to the specified host name or IPv6 address.
write	P	Saves the current configuration to the Zyxel Device. All unsaved changes are lost after the Zyxel Device restarts.

Subsequent chapters in this guide describe the configuration commands. User/privilege mode commands that are also configuration commands (for example, 'show') are described in more detail in the related configuration command chapter.

---

# PART II

## Reference

---

# CHAPTER 3

## Object Reference

This chapter describes how to use object reference commands.

### 3.1 Object Reference Commands

The object reference commands are used to see which configuration settings reference a specific object. You can use this table when you want to delete an object because you have to remove references to the object first.

Table 6 show reference Commands

COMMAND	DESCRIPTION
<code>show reference object username [username]</code>	Displays which configuration settings reference the specified user object.
<code>show reference object address [object_name]</code>	Displays which configuration settings reference the specified address object.
<code>show reference object address6 [object_name]</code>	Displays which configuration settings reference the specified IPv6 address object.
<code>show reference object service [object_name]</code>	Displays which configuration settings reference the specified service object.
<code>show reference object schedule [object_name]</code>	Displays which configuration settings reference the specified schedule object.
<code>show reference object interface [interface_name   virtual_interface_name]</code>	Displays which configuration settings reference the specified interface or virtual interface object.
<code>show reference object aaa authentication [default   auth_method]</code>	Displays which configuration settings reference the specified AAA authentication object.
<code>show reference object ca category {local remote} [cert_name]</code>	Displays which configuration settings reference the specified authentication method object.
<code>show reference object account pppoe [object_name]</code>	Displays which configuration settings reference the specified PPPoE account object.
<code>show reference object account pptp [object_name]</code>	Displays which configuration settings reference the specified PPTP account object.
<code>show reference object app-patrol [profile-name]</code>	Displays which configuration settings reference the specified application patrol profile.
<code>show reference object sslvpn application [object_name]</code>	Displays which configuration settings reference the specified SSL VPN application object.
<code>show reference object crypto map [crypto_name]</code>	Displays which configuration settings reference the specified VPN connection object.

Table 6 show reference Commands (continued)

COMMAND	DESCRIPTION
show reference object isakmp policy [isakmp_name]	Displays which configuration settings reference the specified VPN gateway object.
show reference object sslvpn policy [object_name]	Displays which configuration settings reference the specified SSL VPN object.
show reference object zone [object_name]	Displays which configuration settings reference the specified zone object.
show reference object dhcp6-lease-object [object_name]	Displays which configuration settings reference the specified DHCPv6 lease object.
show reference object dhcp6-request-object [object_name]	Displays which configuration settings reference the specified DHCPv6 request object.
show reference object-group username [username]	Displays which configuration settings reference the specified user group object.
show reference object-group address [object_name]	Displays which configuration settings reference the specified address group object.
show reference object-group address6 [object_name]	Displays which configuration settings reference the specified IPv6 address group object.
show reference object-group service [object_name]	Displays which configuration settings reference the specified service group object.
show reference object-group interface [object_name]	Displays which configuration settings reference the specified trunk object.
show reference object-group aaa ad [group_name]	Displays which configuration settings reference the specified AAA AD group object.
show reference object-group aaa ldap [group_name]	Displays which configuration settings reference the specified AAA LDAP group object.
show reference object-group aaa radius [group_name]	Displays which configuration settings reference the specified AAA RADIUS group object.

### 3.1.1 Object Reference Command Example

This example shows how to check which configuration is using an address object named LAN1\_SUBNET. For the command output, firewall rule 3 named LAN1-to-USG-2000 is using the address object.

```
Router(config)# show reference object address LAN1_SUBNET

LAN1_SUBNET References:
Category
Rule Priority      Rule Name
Description
=====
Security Policy Control
3                 N/A
LAN1-to-USG-2000
Router(config)#
```

# CHAPTER 4

## Status

This chapter explains some commands you can use to display information about the Zyxel Device's current operational state.

Table 7 Status Show Commands

COMMAND	DESCRIPTION
<code>show boot status</code>	Displays details about the Zyxel Device's startup state.
<code>show comport status</code>	Displays whether the console is on or off.
<code>show cpu status</code>	Displays the CPU utilization.
<code>show cpu all</code>	Displays the CPU utilization of each CPU.
<code>show disk</code>	Displays the disk utilization.
<code>show extension-slot</code>	Displays the status of the extension card slot and USB ports and the names of devices connected to them.
<code>show led status</code>	Displays the status of each LED on the Zyxel Device.
<code>show mac</code>	Displays the Zyxel Device's MAC address.
<code>show mem status</code>	Displays what percentage of the Zyxel Device's memory is currently being used.
<code>show ram-size</code>	Displays the size of the Zyxel Device's on-board RAM.
<code>show serial-number</code>	Displays the serial number of this Zyxel Device.
<code>show socket listen</code>	Displays the Zyxel Device's listening ports
<code>show socket open</code>	Displays the ports that are open on the Zyxel Device.
<code>show system uptime</code>	Displays how long the Zyxel Device has been running since it last restarted or was turned on.
<code>show version</code>	Displays the Zyxel Device's model, firmware and build information.
<code>show ap-info total {sta   usage} {24G   5G   all} timer</code>	Displays how many wireless stations are connected to all managed APs or the amount of data (in bytes) sent/received by the connected stations.  <i>timer</i> : a period of time (from 1 to 24 hours) over which the station number is recorded or the traffic flow occurred.
<code>show ap-info top number {sta   usage} timer</code>	Displays how many wireless stations are connected to the top managed AP(s) or the amount of data (in bytes) sent/received by the connected stations.  <i>number</i> : 1 to 64, the top "N" number of managed APs.  <i>timer</i> : a period of time (from 1 to 24 hours) over which the station number is recorded or the traffic flow occurred.
<code>show ap-info {mac_address   all} {sta   usage} {24G   5G   all} timer</code>	Displays how many wireless stations are connected to a specific or all managed APs or the amount of data (in bytes) sent/received by the connected stations.  <i>mac_address</i> : the managed AP's MAC address.  <i>timer</i> : a period of time (from 1 to 24 hours) over which the station number is recorded or the traffic flow occurred.

Table 7 Status Show Commands

COMMAND	DESCRIPTION
<code>show sta-info {mac_address   all} usage timer</code>	Displays data usage of a specific or all connected wireless stations. <i>mac_address</i> : the wireless station's MAC address. <i>timer</i> : a period of time (from 1 to 24 hours) over which the traffic flow occurred.
<code>show sta-info total usage timer</code>	Displays data usage of all connected wireless station(s). <i>timer</i> : a period of time (from 1 to 24 hours) over which the traffic flow occurred.
<code>show sta-info top number usage timer</code>	Displays data usage of the top connected wireless station(s). <i>number</i> : 1 to 64, the top "N" number of connected wireless stations. <i>timer</i> : a period of time (from 1 to 24 hours) over which the traffic flow occurred.

Here are examples of the commands that display the CPU and disk utilization.

Use `show cpu all` to check all the Zyxel Device CPU utilization. Use `show cpu status` to check the Zyxel Device average CPU utilization. You can use these commands to check your cpu status if you feel the Zyxel Device's performance is becoming slower

Use `show disk` to check the percentage of Zyxel Device onboard flash memory that is currently being used. You can use this command to check your disk status if you're having trouble saving files on the Zyxel Device, such as the firmware or the packet capture files.

```
Router(config)# show cpu status
Router> show cpu status
CPU utilization: 11 %
CPU utilization for 1 min: 2 %
CPU utilization for 5 min: 2 %
Router> show cpu all
CPU core 0 utilization: 3 %
CPU core 0 utilization for 1 min: 4 %
CPU core 0 utilization for 5 min: 2 %
CPU core 1 utilization: 0 %
CPU core 1 utilization for 1 min: 2 %
CPU core 1 utilization for 5 min: 4 %
Router> show disk
No. Disk                Size (MB)                Usage
=====
====
1  image                  116                      93%
2  onboard flash         1007                     12%
```

Here are examples of the commands that display the MAC address, memory usage, RAM size, and serial number. You need the MAC address and serial number if you want to pass the Zyxel Device management to Nebula.

```
Router(config)# show mac
MAC address: 28:61:32:89:37:61-28:61:32:89:37:67
Router(config)# show mem status
memory usage: 39%
Router(config)# show ram-size
ram size: 510MB
Router(config)# show serial-number
serial number: XXXXXXXXXXXXX
```

Here is an example of the command that displays the listening ports.

```
Router(config)# show socket listen
```

No.	Proto	Local_Address	Foreign_Address	State
1	tcp	0.0.0.0:2601	0.0.0.0:0	LISTEN
2	tcp	0.0.0.0:2602	0.0.0.0:0	LISTEN
3	tcp	127.0.0.1:10443	0.0.0.0:0	LISTEN
4	tcp	0.0.0.0:2604	0.0.0.0:0	LISTEN
5	tcp	0.0.0.0:80	0.0.0.0:0	LISTEN
6	tcp	127.0.0.1:8085	0.0.0.0:0	LISTEN
7	tcp	1.1.1.1:53	0.0.0.0:0	LISTEN
8	tcp	172.16.37.205:53	0.0.0.0:0	LISTEN
9	tcp	10.0.0.8:53	0.0.0.0:0	LISTEN
10	tcp	172.16.37.240:53	0.0.0.0:0	LISTEN
11	tcp	192.168.1.1:53	0.0.0.0:0	LISTEN
12	tcp	127.0.0.1:53	0.0.0.0:0	LISTEN
13	tcp	0.0.0.0:21	0.0.0.0:0	LISTEN
14	tcp	0.0.0.0:22	0.0.0.0:0	LISTEN
15	tcp	127.0.0.1:953	0.0.0.0:0	LISTEN
16	tcp	0.0.0.0:443	0.0.0.0:0	LISTEN
17	tcp	127.0.0.1:1723	0.0.0.0:0	LISTEN



Here is an example of the command that displays the open ports.

```
Router(config)# show socket open
```

No.	Proto	Local_Address	Foreign_Address	State
1	tcp	172.23.37.240:22	172.23.37.10:1179	ESTABLISHED
2	udp	127.0.0.1:64002	0.0.0.0:0	
3	udp	0.0.0.0:520	0.0.0.0:0	
4	udp	0.0.0.0:138	0.0.0.0:0	
5	udp	0.0.0.0:138	0.0.0.0:0	
6	udp	0.0.0.0:138	0.0.0.0:0	
7	udp	0.0.0.0:138	0.0.0.0:0	
8	udp	0.0.0.0:138	0.0.0.0:0	
9	udp	0.0.0.0:138	0.0.0.0:0	
10	udp	0.0.0.0:138	0.0.0.0:0	
11	udp	0.0.0.0:32779	0.0.0.0:0	
12	udp	192.168.1.1:4500	0.0.0.0:0	
13	udp	1.1.1.1:4500	0.0.0.0:0	
14	udp	10.0.0.8:4500	0.0.0.0:0	
15	udp	172.23.37.205:4500	0.0.0.0:0	
16	udp	172.23.37.240:4500	0.0.0.0:0	
17	udp	127.0.0.1:4500	0.0.0.0:0	
18	udp	127.0.0.1:63000	0.0.0.0:0	
19	udp	127.0.0.1:63001	0.0.0.0:0	
20	udp	127.0.0.1:63002	0.0.0.0:0	
21	udp	0.0.0.0:161	0.0.0.0:0	
22	udp	127.0.0.1:63009	0.0.0.0:0	
23	udp	192.168.1.1:1701	0.0.0.0:0	
24	udp	1.1.1.1:1701	0.0.0.0:0	
25	udp	10.0.0.8:1701	0.0.0.0:0	
26	udp	172.23.37.205:1701	0.0.0.0:0	
27	udp	172.23.37.240:1701	0.0.0.0:0	
28	udp	127.0.0.1:1701	0.0.0.0:0	
29	udp	127.0.0.1:63024	0.0.0.0:0	
30	udp	127.0.0.1:30000	0.0.0.0:0	
31	udp	1.1.1.1:53	0.0.0.0:0	
32	udp	172.23.37.205:53	0.0.0.0:0	
33	udp	10.0.0.8:53	0.0.0.0:0	
34	udp	172.23.37.240:53	0.0.0.0:0	
35	udp	192.168.1.1:53	0.0.0.0:0	
36	udp	127.0.0.1:53	0.0.0.0:0	
37	udp	0.0.0.0:67	0.0.0.0:0	
38	udp	127.0.0.1:63046	0.0.0.0:0	
39	udp	127.0.0.1:65097	0.0.0.0:0	
40	udp	0.0.0.0:65098	0.0.0.0:0	
41	udp	192.168.1.1:500	0.0.0.0:0	
42	udp	1.1.1.1:500	0.0.0.0:0	
43	udp	10.0.0.8:500	0.0.0.0:0	
44	udp	172.23.37.205:500	0.0.0.0:0	
45	udp	172.23.37.240:500	0.0.0.0:0	
46	udp	127.0.0.1:500	0.0.0.0:0	

Here are examples of the commands that display the system uptime and model, firmware, and build information.

```
Router> show system uptime
system uptime: 04:18:00
Router> show version
Zyxel Communications Corp.
model           : ZyWALL USG 110
firmware version: 2.20(AQQ.0)b3
BM version      : 1.08
build date      : 2014-01-21 01:18:06
```

This example shows the current LED states on the Zyxel Device. The **SYS** LED lights on and green. The **HDD** LEDs is off.

```
Router> show led status
sys: green
usbled: off
Router>
```

## 4.1 ATP Dashboard Commands

Use these commands to view status and statistics information about security services on the ZyWALL ATP models.

Table 8 Dashboard Commands

COMMAND	DESCRIPTION
show anti-botnet dashboard statistics summary	Displays the number of the connection attempts detected or blocked, and the number of malware threats.
show ip-reputation dashboard statistics summary	Displays the number of IPv4 addresses that have been scanned, the number of hit counts on the scanned IPv4 addresses, and the number of IPv4 address for each threat level.
show anti-spam dashboard statistics summary	Displays the number of emails that the Zyxel Device's email security feature has checked, the number of spam emails and the number of suspicious websites known for phishing.
show anti-virus statistics summary	Displays the number of viruses detected.
show content-filter dashboard statistics summary	Displays the number of web pages that the Zyxel Device's content filtering feature has checked.
show idp dashboard statistics summary	Displays the number of sessions and packets that the Zyxel Device's IDP feature has checked.
show sandbox dashboard statistics summary	Displays the number of files that have been scanned or destroyed and the scan result.
show security-service status	Displays whether the security service, such as content filtering or sandboxing is enabled on the Zyxel Device.
threat-website dashboard statistics flush	Clears the URL Threat Filter statistics on the dashboard.
content-filter dashboard statistics flush	Clears the content-filter statistics on the dashboard.

## 4.2 CPU Temperature Monitor Commands

Use these commands to have the Zyxel Device periodically write CPU temperatures to the system logs.

Table 9 Dashboard Commands

COMMAND	DESCRIPTION
<code>show cpu-temperature-monitor status</code>	Displays whether CPU temperature monitoring is enabled, and how often the temperature is written to the system logs.
<code>[no] cpu-temperature-monitor activate</code>	Enables or disables CPU monitoring.
<code>cpu-temperature-monitor period <i>minutes</i></code>	Sets how often in minutes that the Zyxel Device writes CPU temperature to the system logs. The valid range is 5-120.
<code>cpu-temperature-monitor unit {celsius  fahrenheit}</code>	Sets the temperature unit that the Zyxel Device uses when it writes CPU temperature to the system logs.

# CHAPTER 5

## Registration

This chapter introduces myZyxel and shows you how to register the Zyxel Device for IDP/AppPatrol, anti-virus, content filtering, and SSL VPN services using commands.

### 5.1 myZyxel Overview

myZyxel is Zyxel's online services center where you can register your Zyxel Device and manage subscription services available for the Zyxel Device.

Note: You need to create an account before you can register your device and activate the services at myZyxel.

First, go to <http://www.myZyxel> with the Zyxel Device's serial number and LAN MAC address to register the Zyxel Device. Refer to the web site's on-line help for details. You can also go to the portal and see license status using the **Licensing > Registration** screens.

Note: To activate a service on a Zyxel Device, you need to access myZyxel via that Zyxel Device.

#### 5.1.1 Subscription Services Available on the Zyxel Device

Refer to [Section 1.4.6 on page 32](#) for differences between ATP and USG license names.

The Zyxel Device can use anti-virus, anti-spam, IDP/AppPatrol (Intrusion Detection and Prevention and application patrol), SSL VPN, and content filtering subscription services.

ZyWALL models need a license for UTM (Unified Threat Management) functionality. See the Introduction chapter in the Zyxel Device User's Guide or the product datasheet for details.

You can purchase an EiCard and enter the license key from it, at <http://www.myZyxel.com> to have the ZyWALL use UTM services or have the Zyxel Device use more SSL VPN tunnels. See the respective chapters in the User's Guide for more information about UTM features.

- The Zyxel Device's anti-virus packet scanner uses signature files on the Zyxel Device to detect virus. Your Zyxel Device scans files transmitted through enabled interfaces into the network. Subscribe to signature updates for Zyxel's anti-virus engine. After the service is activated, the Zyxel Device can download the up-to-date signatures from the update server.

After the trial expires, you need to purchase an EiCard and enter the PIN number (license key) at <http://www.myZyxel.com>.

- The IDP and application patrol features use IDP/AppPatrol signatures on the Zyxel Device. IDP detects malicious or suspicious packets and responds immediately. Application patrol conveniently manages the use of various applications on the network. After the service is activated, the Zyxel Device can download the up-to-date signature files from the update server.

- SSL VPN tunnels provide secure network access to remote users. You can purchase and enter a license key to have the Zyxel Device use more SSL VPN tunnels.
- Content filter allows or blocks access to web sites. Subscribe to category-based content filtering to block access to categories of web sites based on content. Your Zyxel Device accesses an external database that has millions of web sites categorized based on content. You can have the Zyxel Device block, block and/or log access to web sites based on these categories.
- You will get automatic e-mail notification of new signature releases from mySecurityZone after you activate the IDP/AppPatrol service. You can also check for new signatures at <http://mysecurity.zyxel.com>.

See the respective chapters for more information about these features.

Note: To update the signature file or use a subscription service, you have to register the Zyxel Device and activate the corresponding service at myZyxel (through the Zyxel Device).

## 5.2 Registration Commands

The following table describes the commands available for registration. You must use the `configure terminal` command to enter the configuration mode before you can use these commands.

Table 10 Command Summary: Registration

COMMAND	DESCRIPTION
<code>service-register checkexpire</code>	Gets information of all service subscriptions from myZyxel and updates the status table.
<code>service-register _setremind {after-10-days   after-180-days   after-30-days   every-time   never}</code>	Sets how often you want to display the network risk warning screen in the Web Configurator. The screen shows the security services which are not registered or disabled on the Zyxel Device.
<code>show device-register status</code>	Displays whether the device is registered and account information.
<code>show service-register status {all   application-security   as   av   cdr   concurrent-device-upgrade   content-filter   firmware-upgrade   geo-ip   idp   malware-blocker   ctdb   managed-ap-service   pkg   reputation-filter   sandbox   secu-reporter   secure-wifi   sslvpn   sslvpn-status   web-security   zymesh}</code>	Displays the status of your service registrations. Use <b>all</b> to show all registrations as a list.  Note: Values for this command might vary depending on the Zyxel Device model and firmware version.
<code>show service-register status content-filter {commtouch}</code>	Displays Commtouch content filter service license information.
<code>show service-register status sslvpn-status</code>	Displays the status of SSL VPN tunnels.  The first number is the actual number of VPN tunnels up and the second number is the maximum number of SSL VPN tunnels allowed.
<code>show service-register content-filter-engine</code>	Displays which external web filtering service the Zyxel Device is set to use for content filtering.

## 5.2.1 Command Examples

The following command displays the account information and whether the device is registered.

```
Router# configure terminal
Router(config)# show device-register status
username           : example
password           : 123456
device register status : yes
expiration self check : no
```

The following command displays the service registration status and type and how many days remain before the service expires.

```
Router# configure terminal
Router(config)# show service-register status all
Service           Status      Type      Count      Expiration
=====
IDP Signature     Licensed   Standard  N/A        176
Anti-Virus        Not Licensed None       N/A        0
SSLVPN            Not Licensed None       5          N/A
Content-Filter    Not Licensed None       N/A        0
```

# CHAPTER 6

## AP Management

This chapter shows you how to configure wireless AP management options on your Zyxel Device.

### 6.1 AP Management Overview

The Zyxel Device allows you to remotely manage all of the Access Points (APs) on your network. You can manage a number of APs without having to configure them individually as the Zyxel Device automatically handles basic configuration for you.

The commands in this chapter allow you to add, delete, and edit the APs managed by the Zyxel Device by means of the CAPWAP protocol. An AP must be moved from the wait list to the management list before you can manage it. If you do not want to use this registration mechanism, you can disable it and then any newly connected AP is registered automatically.

### 6.2 AP Management Values

The following table identifies the values required for many of these commands. Other input values are discussed with the corresponding commands.

Table 11 Input Values for AP Management Commands

LABEL	DESCRIPTION
<i>ap_mac</i>	The Ethernet MAC address of the managed AP. Enter 6 hexadecimal pairs separated by colons. You can use 0-9, a-z and A-Z.
<i>ap_model</i>	The model name of the managed AP, such as NWA5160N, NWA5560-N, NWA5550-N, NWA5121-NI or NWA5123-NI.
<i>slot_name</i>	The slot name for the AP's on-board wireless LAN card. Use either <i>slot1</i> or <i>slot2</i> . (The NWA5560-N supports up to 2 radio slots.)
<i>profile_name</i>	The wireless LAN radio profile name. You may use 1-31 alphanumeric characters, underscores(_), or dashes (-), but the first character cannot be a number. This value is case-sensitive.
<i>ap_description</i>	The AP description. This is strictly used for reference purposes and has no effect on any other settings. You may use 1-31 alphanumeric characters, underscores(_), or dashes (-), but the first character cannot be a number. This value is case-sensitive.
<i>sta_mac</i>	The MAC address of the wireless client. Enter 6 hexadecimal pairs separated by colons. You can use 0-9, a-z and A-Z.

## 6.3 General AP Management Commands

The following table describes the commands available for general AP management. You must use the `configure terminal` command to enter the configuration mode before you can use these commands.

Table 12 Command Summary: AP Management

COMMAND	DESCRIPTION
<code>[no] capwap activate</code>	Enables or disables the AP controller service.
<code>capwap ap ap_mac</code>	Enters the sub-command mode for the specified AP.
<code>slot_name ap-profile profile_name</code>	Sets the radio ( <i>slot_name</i> ) to AP mode and assigns a created profile to the radio.
<code>no slot_name ap-profile</code>	Removes the AP mode profile assignment for the specified radio ( <i>slot_name</i> ).
<code>slot_name monitor-profile profile_name</code>	Sets the specified radio ( <i>slot_name</i> ) to monitor mode and assigns a created profile to the radio. Monitor mode APs act as wireless monitors, which can detect rogue APs and help you in building a list of friendly ones. See also <a href="#">Section 9.2 on page 74</a> .
<code>no slot_name monitor-profile</code>	Removes the monitor mode profile assignment for the specified radio ( <i>slot_name</i> ).
<code>slot_name {root-ap   repeater-ap} zymesh-profile_name</code>	Sets the specified radio ( <i>slot_name</i> ) to root AP or repeater mode and assigns a created ZyMesh profile to the radio. See also <a href="#">Section 9.6 on page 93</a> for more information about ZyMesh.
<code>slot_name wireless-bridge {enable   disable}</code>	<p>Enables or disables wireless bridging on the specified radio (<i>slot_name</i>). The managed AP must support LAN provision and the radio should be in repeater mode. VLAN and bridge interfaces are created automatically according to the LAN port's VLAN settings.</p> <p>When wireless bridging is enabled, the managed repeater AP can still transmit data through its Ethernet port(s) after the ZyMesh/WDS link is up. Be careful to avoid bridge loops.</p> <p>The managed APs in the same ZyMesh/WDS must use the same static VLAN ID.</p>
<code>antenna config slot_name chain3 {ceiling   wall}</code>	Adjusts coverage depending on each radio's antenna orientation for better coverage.
<code>[no] antenna sw-control enable</code>	<p>Enables the adjustment of coverage depending on the orientation of the antenna for the AP radios using the web configurator or the command line interface (CLI),</p> <p>The <code>no</code> command disables adjustment through the web configurator or the command line interface (CLI). You can still adjust coverage using a physical antenna switch.</p>
<code>ap-group-profile ap-group-profile_name</code>	Sets the AP group to which the AP belongs.
<code>description ap_description</code>	Sets the description for the specified AP.



Table 12 Command Summary: AP Management (continued)

COMMAND	DESCRIPTION
[no] force vlan	Sets whether or not the Zyxel Device changes the AP's management VLAN to match the one you configure using the <code>vlan</code> sub-command. The management VLAN on the Zyxel Device and AP must match for the Zyxel Device to manage the AP.  This takes priority over the AP's CAPWAP client commands described in <a href="#">Chapter 73 on page 587</a> .
lan-provision lan_port {activate   inactivate} pvid <1..4094>	Sets the Zyxel Device to enable or disable the specified LAN port on the AP and configures a PVID (Port VLAN ID) for this port.  <i>lan_port</i> : the name of the AP's LAN port (lan1 for example).
lan-provision vlan_interface {activate   inactivate} vid <1..4094> join lan_port {tag   untag} [lan_port {tag   untag}] [lan_port {tag   untag}]	Sets the Zyxel Device to create a new VLAN or configure an existing VLAN. You can disable or enable the VLAN, set the VLAN ID, assign up to three ports to this VLAN as members and set whether the port is to tag outgoing traffic with the VLAN ID.  <i>vlan_interface</i> : the name of the VLAN (vlan1 for example).
[no] override-full-power activate	Forces the AP to draw full power from the power sourcing equipment. This improves performance in cases when a PoE injector that does not support PoE negotiation is used.  Use the <code>no</code> command to disable this feature.
[no] load-balancing <group1   group2> group_name	Assigns a load balancing group to the AP.  Use the <code>no</code> command to remove the group1 or group2 assignment of the AP.
[no] override slot_name {output-power   radio-setting   ssid-setting}	Sets the Zyxel Device to overwrite the AP's output power, radio or SSID profile settings for the specified radio.  Use the <code>no</code> command to not overwrite the specified settings.
[no] override lan-provision	Sets the Zyxel Device to overwrite the AP's LAN port settings.  Use the <code>no</code> command to not overwrite the specified settings.
[no] override vlan-setting	Sets the Zyxel Device to overwrite the AP's LAN port settings.  Use the <code>no</code> command to not overwrite the specified settings.
vlan <1..4094> {tag   untag}	Sets the VLAN ID for the specified AP as well as whether packets sent to and from that ID are tagged or untagged.
exit	Exits the sub-command mode for the specified AP.
capwap ap ac-ip {primary_ac_ip} {secondary_ac_ip}	Specifies the primary and secondary IP address or domain name of the AP controller (the Zyxel Device) to which the AP connects.
capwap ap ac-ip auto	Sets the AP to use DHCP to get the address of the AP controller (the Zyxel Device).
capwap ap add ap_mac [ap_model]	Adds the specified AP to the Zyxel Device for management. If manual add is disabled, this command can still be used; if you add an AP before it connects to the network, then this command simply preconfigures the management list with that AP's information.
capwap ap factory default ap_mac	Resets the specified AP to its factory default settings.
capwap ap fallback disable	Sets the managed AP(s) to not change back to associate with the primary AP controller when the primary AP controller is available.

Table 12 Command Summary: AP Management (continued)

COMMAND	DESCRIPTION
<code>capwap ap fallback enable</code>	Sets the managed AP(s) to change back to associate with the primary AP controller as soon as the primary AP controller is available.
<code>capwap ap fallback interval &lt;30..86400&gt;</code>	Sets how often (in seconds) the managed AP(s) check whether the primary AP controller is available.
<code>capwap ap idle timeout {25-100}</code>	Sets the default period after which idle wireless clients are kicked from an AP, in minutes.  This setting takes affect if setting <b>Disassociate station when overloaded</b> is enabled.
<code>capwap ap kick {all   ap_mac}</code>	Removes the specified AP ( <i>ap_mac</i> ) or all connected APs ( <i>all</i> ) from the management list. Doing this removes the AP(s) from the management list.  If the Zyxel Device is set to automatically add new APs to the AP management list, then any kicked APs are added back to the management list as soon as they reconnect.
<code>capwap ap led-off ap_mac</code>	Sets the LEDs of the specified AP to turn off after it's ready.
<code>capwap ap led-on ap_mac</code>	Sets the LEDs of the specified AP to stay lit after the Zyxel Device is ready.
<code>capwap ap reboot ap_mac</code>	Forces the specified AP ( <i>ap_mac</i> ) to restart. Doing this severs the connections of all associated stations.
<code>capwap manual-add {enable   disable}</code>	Allows the Zyxel Device to either automatically add new APs to the network ( <i>disable</i> ) or wait until you manually confirm them ( <i>enable</i> ).
<code>capwap station kick sta_mac</code>	Forcibly disconnects the specified station from the network.
<code>show capwap ap {all   ap_mac}</code>	Displays information of all managed APs ( <i>all</i> ) or information of an AP on the Specified MAC address ( <i>ap_mac</i> ).
<code>show capwap ap {all   ap_mac} config status</code>	Displays whether or not any AP's configuration or the specified AP's configuration is in conflict with the Zyxel Device's settings for the AP, and displays the settings in conflict if there are any.
<code>country-code country_code</code>	Sets the country where the Zyxel Device is located/installed.  This is the default country code the Zyxel Device uses in a new radio profile or monitor profile if you do not change it. The available channels vary depending on the country you selected.  <i>country_code</i> : 2-letter country-codes, such as TW, DE, or FR.
<code>lan-provision ap ap_mac</code>	Enters the sub-command mode for the specified AP
<code>lan_port {activate   inactivate} pvid &lt;1..4094&gt;</code>	Enables or disables the specified LAN port on the AP and configures a PVID (Port VLAN ID) for this port.  <i>lan_port</i> : the name of the AP's LAN port (lan1 for example).
<code>vlan_interface {activate   inactivate} vid &lt;1..4094&gt; join lan_port {tag   untag} [lan_port {tag   untag}] [lan_port {tag   untag}]</code>	Creates a new VLAN or configures an existing VLAN. You can disable or enable the VLAN, set the VLAN ID, assign up to three ports to this VLAN as members and set whether the port is to tag outgoing traffic with the VLAN ID.  <i>vlan_interface</i> : the name of the VLAN (vlan1 for example).
<code>[no] vlan_interface</code>	Removes the specified VLAN.

Table 12 Command Summary: AP Management (continued)

COMMAND	DESCRIPTION
<code>ap internal-auth shared-secret key</code>	Enter the shared secret key used by APs to authenticate with an Access Point Controller (APC) authentication server.  The key is encrypted before being saved to the Zyxel Device.  You can use the following characters: 0-9a-zA-Z -!@#\$\$%^&*()_ \-+={}  \\\:;<,>\?.\
<code>ap internal-auth no shared-secret</code>	Resets the shared secret key to default.
<code>show capwap ap {all   ap_mac}</code>	Displays the management list ( <i>all</i> ) or whether the specified AP is on the management list ( <i>ap_mac</i> ).
<code>show capwap ap ap_mac slot_name detail</code>	Displays details for the specified radio ( <i>slot_name</i> ) on the specified AP ( <i>ap_mac</i> ).
<code>show capwap ap {all   ap_mac} config status</code>	Displays whether or not any AP's configuration or the specified AP's configuration is in conflict with the Zyxel Device's settings for the AP and displays the settings in conflict if there are any.
<code>show capwap ap ac-ip</code>	Displays the address of the Zyxel Device or <code>auto</code> if the AP finds the Zyxel Device through broadcast packets.
<code>show capwap ap all statistics</code>	Displays radio statistics for all APs on the management list.
<code>show capwap ap fallback</code>	Displays whether the managed AP(s) will change back to associate with the primary AP controller when the primary AP controller is available.
<code>show capwap ap fallback interval</code>	Displays the interval for how often the managed AP(s) check whether the primary AP controller is available.
<code>show capwap ap idle timeout</code>	Displays the default period after which idle wireless clients are kicked from an AP, in minutes.
<code>show capwap ap wait-list</code>	Displays a list of connected but as-of-yet unmanaged APs. This is known as the 'wait list'.
<code>show capwap manual-add</code>	Displays the current manual add option.
<code>show capwap station all</code>	Displays information for all stations connected to the APs on the management list.
<code>show country-code list</code>	Displays a reference list of two-letter country codes.
<code>show default country-code</code>	Displays the default country code configured on the Zyxel Device.
<code>show lan-provision ap ap_mac interface {lan_port   vlan_interface   all  ethernet   uplink   vlan}</code>	Displays the port and/or VLAN settings for the specified AP.  You can also set to display settings for a specified port, a specified VLAN, all physical Ethernet ports, the uplink port or all VLANs on the AP.

### 6.3.1 AP Management Commands Example

The following example shows you how to add an AP to the management list, and then edit it.

```
Router# show capwap ap wait-list
index: 1
  IP: 192.168.1.35, MAC: 00:11:11:11:11:FE
  Model: NWA5160N, Description: AP-00:11:11:11:11:FE
index: 2
  IP: 192.168.1.36, MAC: 00:19:CB:00:BB:03
  Model: NWA5160N, Description: AP-00:19:CB:00:BB:03
Router# configure terminal
Router(config)# capwap ap add 00:19:CB:00:BB:03
Router(config)# capwap ap 00:19:CB:00:BB:03
Router(AP 00:19:CB:00:BB:03)# slot1 ap-profile approf01
Router(AP 00:19:CB:00:BB:03)# exit
Router(config)# show capwap ap all
index: 1
  Status: RUN
  IP: 192.168.1.37, MAC: 40:4A:03:05:82:1E
  Description: AP-404A0305821E
  Model: NWA5160N
  R1 mode: AP, R1Prof: default
  R2 mode: AP, R2Prof: n/a
  Station: 0, RadioNum: 2
  Mgnt. VLAN ID: 1, Tag: no
  WTP VLAN ID: 1, WTP Tag: no
  Force VLAN: disable
  Firmware Version: 2.25(AAS.0)b2
  Recent On-line Time: 08:43:04 2013/05/24
  Last Off-line Time: N/A

Router(config)# show capwap ap 40:4A:03:05:82:1E slot1 detail
index: 1
  SSID: Zyxel, BSSID: 40:4A:03:05:82:1F
  SecMode: NONE, Forward Mode: Local Bridge, Vlan: 1

Router(config)# show capwap ap all statistics
index: 1
  Status: RUN, Loading: -
  AP MAC: 40:4A:03:05:82:1E
  Radio: 1, OP Mode: AP
  Profile: default, MAC: 40:4A:03:05:82:1F
  Description: AP-404A0305821E
  Model: NWA5160N
  Band: 2.4GHz, Channel: 6
  Station: 0
  RxPkt: 4463, TxPkt: 38848
  RxFCS: 1083323, TxRetry: 198478
```

The following example displays the management list and radio statistics for the specified AP.

```
Router(config)# show capwap ap all
index: 1
  Status: RUN
  IP: 192.168.1.37, MAC: 60:31:97:82:F5:AF
  Description: AP-60319782F5AF
  Model: WAC5302D-S
  CPU Usage: 12 %
  R1 mode: AP, R1Prof: default
  R2 mode: AP, R2Prof: default2
  AP Group Profile: default
  Override Slot1 Radio Profile: disable
  Override Slot1 SSID Profile: disable
  slot1-SSID Profile 1: default
  slot1-SSID Profile 2:
  slot1-SSID Profile 3:
  slot1-SSID Profile 4:
  slot1-SSID Profile 5:
  slot1-SSID Profile 6:
  slot1-SSID Profile 7:
  slot1-SSID Profile 8:
  Override Slot1 Output Power: disable
  Slot1 Output Power: 30dBm
  Override Slot2 Radio Profile: disable
  Override Slot2 SSID Profile: disable
  slot2-SSID Profile 1: default
  slot2-SSID Profile 2:
  slot2-SSID Profile 3:
  slot2-SSID Profile 4:
  slot2-SSID Profile 5:
  slot2-SSID Profile 6:
  slot2-SSID Profile 7:
  slot2-SSID Profile 8:
  Override Slot2 Output Power: disable
  Slot2 Output Power: 30dBm
  Station: 2, RadioNum: 2
  Override VLAN Setting: disable
  Mgmt. VLAN ID: 1, Tag: no
  WTP VLAN ID: 1, WTP Tag: no
  Force VLAN: disable
  Support Lan-provision: yes
  Override LAN Provision: disable
  Firmware Version: 5.00(ABFH.1)b1
  Primary AC IP: broadcast
  Secondary AC IP: N/A
  Recent On-line Time: 03:15:30 2016/11/11
  Last Off-line Time: 03:10:48 2016/11/11
  Loop State: N/A
  LED Status: N/A
  Suppress Mode Status: Enable
  Locator LED Status: N/A
  Locator LED Time: 0
  Locator LED Time Lease: 0
  Power Mode: Full
  Antenna Switch SW-Control: N/A
  Antenna Switch Radio 1: N/A
  Antenna Switch Radio 2: N/A
```

```
Compatible: No
Capability: 32
Port Number: 4
Router(config)# show capwap ap 60:31:97:82:F5:AF slot1 detail
index: 1
  SSID: ZyXEL
  BSSID: 60:31:97:82:F5:B0
  SecMode: NONE, Forward Mode: Local Bridge, Vlan: 1
Router(config)# show capwap ap all statistics
index: 1
  Status: RUN, Loading: -
  AP MAC: 60:31:97:82:F5:AF
  Radio: 1, OP Mode: AP
  Profile: default, MAC: F0:FD:F0:FD:F0:FD
  Description: AP-60319782F5AF
  Model: WAC5302D-S
  Band: 2.4GHz, Channel: 6
  Station: 0
  Rx: 101395, Tx: 866288
  RxFCS: 42803, TxRetry: 897
  TxPower: 15 dBm
  Antenna Type: N/A

index: 2
  Status: RUN, Loading: -
  AP MAC: 60:31:97:82:F5:AF
  Radio: 2, OP Mode: AP
  Profile: default2, MAC: F0:FD:F0:FD:F0:FD
  Description: AP-60319782F5AF
  Model: WAC5302D-S
  Band: 5GHz, Channel: 36/40
  Station: 2
  Rx: 864251, Tx: 1076862
  RxFCS: 169608, TxRetry: 2816
  TxPower: 16 dBm
  Antenna Type: N/A

Router(config)#
```

## 6.4 Remote AP

Remote AP enables the ZyXEL device to connect to an Access Point (AP) through a secure VPN tunnel. This allows you to set up VPN-enabled WiFi APs in remote locations, such as in a branch office or at home. Clients connected to these APs can securely access your network through the VPN tunnel.

Figure 15 Remote AP: Secure Tunnel SSID

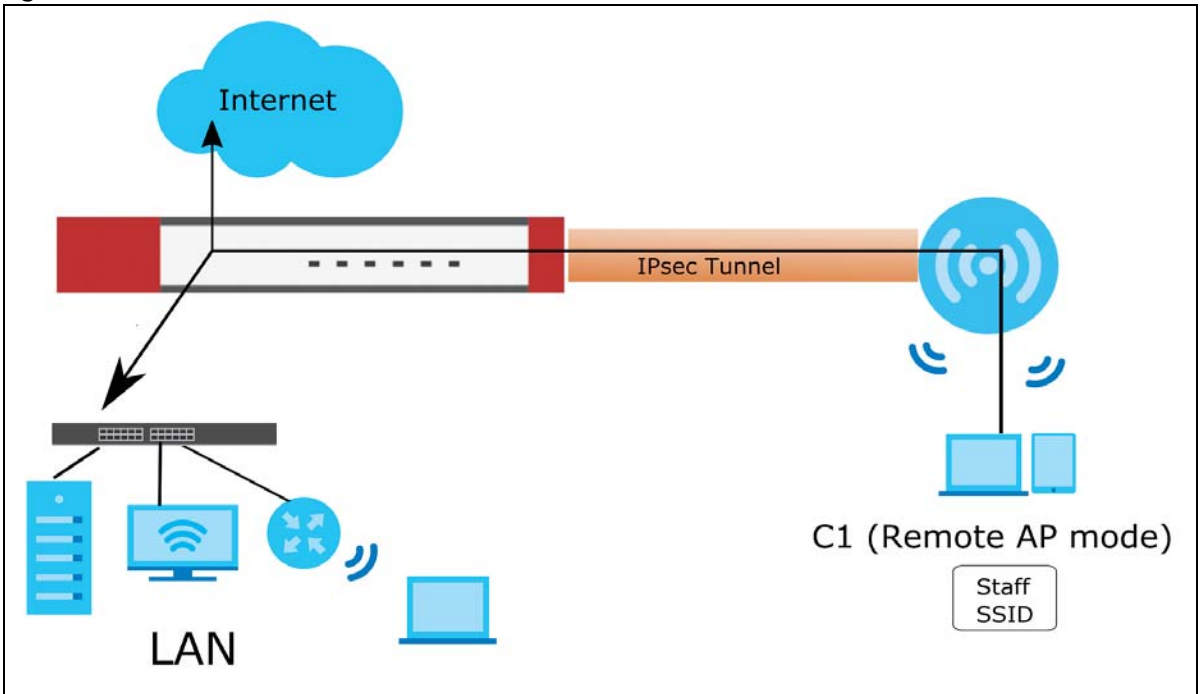
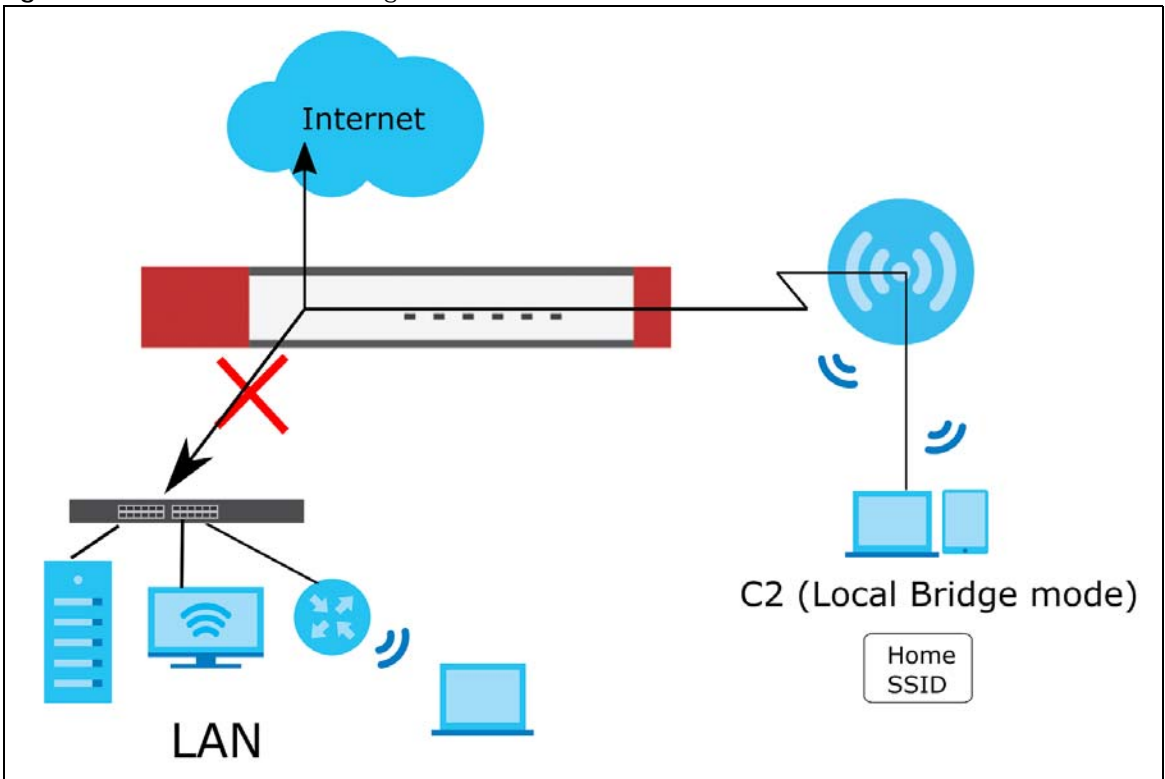

Figure 16 Remote AP: Local Bridge SSID



### 6.4.1 Remote AP Notes

- When you enable Remote AP, the Zyxel Device automatically creates a secure Network Virtualization Using Generic Routing Encapsulation (NVGRE) over IPsec tunnel between itself and the AP using the default VPN profile `_remote_ap_vpn_profile`. This profile cannot be edited.

- The first time Remote AP is enabled on an AP, the Zyxel Device adds the CAPWAP-CONTROL service to the service group Default\_Allow\_WAN\_To\_ZyWALL. If Remote AP is disabled on all APs, this rule is removed.
- Enabling Remote AP automatically enables Ethernet and wireless storm control on the AP.
- Remote AP is only supported on certain AP models. To check whether an AP supports Remote AP, run the command `show capwap ap ap_mac`, and then ensure that "Remote AP Capability" equals "Yes".
- Remote AP only supports IP version 4 (IPv4).

## 6.4.2 Remote AP Commands

The following table describes the commands available for managing Remote AP (RAP). You must use the `configure terminal` command to enter the configuration mode before you can use these commands.

Table 13 Command Summary: Remote AP Management

COMMAND	DESCRIPTION
<code>capwap ap ap_mac</code>	Enters the sub-command mode for the specified AP.
<code>role remote</code>	Enables the Remote AP feature on the AP.
<code>no role</code>	Disables the Remote AP feature on the AP.
<code>rap slot_name ap-profile profile_name</code>	Sets the radio ( <i>slot_name</i> ) to AP mode and assigns a created profile to the radio.
<code>no rap slot_name ap-profile</code>	Removes the AP mode profile assignment for the specified radio ( <i>slot_name</i> ).
<code>rap slot_name output-power wlan_power</code>	Sets the output power (between 0 to 30 dBm) for the AP radio.
<code>rap slot_name ssid-profile &lt;1..6&gt; ssid_profile_name [tunlif interface] vid vlan_id</code>	<p>Sets an SSID profile and VLAN ID that is associated with this AP. You can associate up to six SSID profiles with a Remote AP radio.</p> <ul style="list-style-type: none"> <li>• SSID profiles 1 to 4 are Secure Tunnel SSIDs. Network traffic from clients connected to these SSIDs is sent through the RAP tunnel to the ZyXEL device. The ZyXEL device then sends the traffic out through the interface defined in the SSID profile. This outgoing interface can be overridden by specifying an interface with the command <code>tunlif</code>.</li> <li>• SSID profiles 5 and 6 are Local Bridge SSIDs. Network traffic from clients connected to these SSIDs is sent directly to the network through the AP's local gateway.</li> <li>• Traffic is tagged with the VLAN ID defined by <i>vlan_id</i>.</li> </ul>
<code>no rap slot_name ssid-profile &lt;1..6&gt;</code>	Removes the SSID profile from the AP.
<code>show sa monitor [ap-description desc] rap</code>	Displays the current IPsec SA for each Remote AP.
<code>vpn-policy-pool start start_ip end end_ip</code>	<p>Sets the start and end IPv4 addresses for the shared Remote AP IP address pool.</p> <p>The interface of the RAP IPsec tunnel on the AP is assigned an IP address from this pool.</p>
<code>show vpn-policy-pool</code>	Displays the start and end IPv4 address for the Remote AP VPN pool.



# CHAPTER 7

## Built-in AP

If your Zyxel Device has a built-in AP, then use this function to allow WiFi clients to access your Zyxel Device wirelessly to connect to the network.

Note: The Zyxel Device cannot manage external APs when the built-in AP is enabled.

Table 14 Input Values for Built-in AP Commands

LABEL	DESCRIPTION
<i>slot_name</i>	The slot name for the Zyxel Device's on-board wireless LAN card. Use either <i>slot1</i> or <i>slot2</i> .

## 7.1 Built-in AP Commands

Table 15 Command Summary: Built-in AP

COMMAND	DESCRIPTION
<code>capwap ap local-ap</code>	Enter sub-command mode for the built-in AP.
<code>[no] slot_name ap-profile radio_profile_name</code>	Sets the specified built-in radio to work as an AP and specifies the radio profile the radio is to use.  Use the <code>no</code> command to remove the specified profile.
<code>[no] slot_name monitor-profile monitor_profile_name</code>	Sets the specified built-in radio to work in monitor mode and specifies the monitor profile the radio is to use.  Use the <code>no</code> command to remove the specified profile.
<code>[no] slot_name output-power wlan_power</code>	Sets the output power (between 0 to 30 dBm) for the built-in AP radio.  Use the <code>no</code> command to remove the output power setting.
<code>[no] slot_name ssid-profile &lt;1..8&gt; ssid_profile_name</code>	Sets the SSID profile that is associated with this profile.  You can associate up to eight SSID profiles with an AP radio.  Use the <code>no</code> command to remove the specified profile.
<code>[no] slot_name zymesh-profile zymesh_profile_name</code>	Sets the ZyMesh profile the built-in AP radio (in root AP or repeater mode) uses to connect to a root AP or repeater.  Use the <code>no</code> command to remove the specified profile.
<code>ap-group-profile ap-group- profile_name</code>	Sets the AP group to which the built-in AP belongs.

COMMAND	DESCRIPTION
[no] ap-mode detection activate	Sets the built-in AP to detect Rogue APs in then network. Use the <code>no</code> parameter to disable rogue AP detection. For details about this feature, see <a href="#">Chapter 10 on page 95</a> .
location <i>location</i>	Sets the name of the place where the AP is located, for admin reference. Use the <code>no</code> command to remove the specified setting.
[no] override <i>slot_name</i> {output-power   radio-setting   ssid-setting}	Sets the Zyxel Device to overwrite the built-in AP's output power, radio or SSID profile settings for the specified radio. Use the <code>no</code> command to not overwrite the specified settings.
sysname <i>system_name</i>	Sets a name to identify the AP on a network. This is usually the AP's fully qualified domain name. Use the <code>no</code> command to remove the specified setting.
exit	Exits sub-command mode.

# Chapter 8

## AP Group

If your Zyxel Device has a built-in AP, then use this function to allow WiFi clients to access your Zyxel

Device wirelessly to connect to the network. This chapter shows you how to configure AP groups, which define the radio, port, VLAN and load balancing settings and apply the settings to all APs in the group. An AP can belong to one AP group at a time.

### 8.1 Wireless Load Balancing Overview

Wireless load balancing is the process whereby you limit the number of connections allowed on an wireless access point (AP) or you limit the amount of wireless traffic transmitted and received on it. Because there is a hard upper limit on the AP's wireless bandwidth, this can be a crucial function in areas crowded with wireless users. Rather than let every user connect and subsequently dilute the available bandwidth to the point where each connecting device receives a meager trickle, the load balanced AP instead limits the incoming connections as a means to maintain bandwidth integrity.

### 8.2 AP Group Commands

The following table identifies the values required for many of these commands. Other input values are discussed with the corresponding commands.

Table 16 Input Values for General AP Management Commands

LABEL	DESCRIPTION
<i>ap_group_profile_name</i>	The wireless LAN radio profile name. You may use 1-31 alphanumeric characters, underscores(_), or dashes (-), but the first character cannot be a number. This value is case-sensitive.
<i>slot_name</i>	The slot name for the AP's on-board wireless LAN card. Use either <i>slot1</i> or <i>slot2</i> . (The NWA5560-N supports up to 2 radio slots.)

The following table describes the commands available for AP groups. You must use the `configure terminal` command to enter the configuration mode before you can use these commands.

Table 17 Command Summary: AP Group

COMMAND	DESCRIPTION
<code>ap-group first-priority ap_group_profile_name</code>	Sets an AP group file that is used as the default group file. Any AP that is not configured to associate with a specific AP group belongs to the default group automatically.
<code>ap-group flush wtp-setting ap_group_profile_name</code>	Sets the Zyxel Device to overwrite the settings of all managed APs in the specified group with the group profile settings.

Table 17 Command Summary: AP Group (continued)

COMMAND	DESCRIPTION
<pre>ap-group-member ap_group_wlan_name [no] member local-ap</pre>	<p>Specifies the SSID of the built-in AP that you want to apply the specified AP group profile and add to the group.</p> <p>Use the <code>no</code> command to remove the built-in AP from this group.</p>
<pre>ap-group-member ap_group_profile_name [no] member mac_address</pre>	<p>Specifies the MAC address of the AP that you want to apply the specified AP group profile and add to the group.</p> <p>Use the <code>no</code> command to remove the specified AP from this group.</p>
<pre>[no] ap-group-profile ap_group_profile_name</pre>	<p>Enters configuration mode for the specified AP group profile. Use the <code>no</code> command to remove the specified profile.</p>
<pre>[no] slot_name ap-profile radio_profile_name</pre>	<p>Sets the specified radio to work as an AP and specifies the radio profile the radio is to use.</p> <p>Use the <code>no</code> command to remove the specified profile.</p>
<pre>[no] slot_name monitor-profile monitor_profile_name interval</pre>	<p>Sets the specified radio to work in monitor mode and specifies the monitor profile the radio is to use.</p> <p>Use the <code>no</code> command to remove the specified profile.</p>
<pre>[no] slot_name output-power wlan_power</pre>	<p>Sets the output power (between 0 to 30 dBm) for the radio on the AP that belongs to this group.</p> <p>Use the <code>no</code> command to remove the output power setting.</p>
<pre>[no] slot_name ssid-profile &lt;1..8&gt; ssid_profile_name</pre>	<p>Sets the SSID profile that is associated with this profile.</p> <p>You can associate up to eight SSID profiles with an AP radio.</p> <p>Use the <code>no</code> command to remove the specified profile.</p>
<pre>[no] slot_name repeater-ap radio_profile_name</pre>	<p>Sets the specified AP radio to work as a repeater and specifies the radio profile the radio is to use.</p> <p>Use the <code>no</code> command to remove the specified profile.</p>
<pre>[no] slot_name root-ap radio_profile_name</pre>	<p>Sets the specified radio to work as a root AP and specifies the radio profile the radio is to use.</p> <p>A root AP supports the wireless connections with other APs (in repeater mode) to form a ZyMesh to extend its wireless network.</p> <p>Use the <code>no</code> command to remove the specified profile.</p>
<pre>[no] slot_name zymesh-profile zymesh_profile_name</pre>	<p>Sets the ZyMesh profile the radio (in root AP or repeater mode) uses to connect to a root AP or repeater.</p> <p>Use the <code>no</code> command to remove the specified profile.</p>
<pre>description description</pre>	<p>Sets a description for this group. You can use up to 31 characters, spaces and underscores allowed.</p> <p>Use the <code>no</code> command to remove the specified description.</p>
<pre>exit</pre>	<p>Exits configuration mode for this profile.</p>
<pre>[no] force vlan</pre>	<p>Sets the Zykel Device to change the AP's management VLAN to match the configuration in this profile.</p> <p>Use the <code>no</code> command to not change the AP's management VLAN setting.</p>

Table 17 Command Summary: AP Group (continued)

COMMAND	DESCRIPTION
<pre>[no] lan-provision model {nwa5301-nj   wac6502d-e   wac6502d-s   wac6503d-s   wac6553d-e} ap_lan_port activate pvid &lt;1..4094&gt;</pre>	<p>Sets the model of the managed AP and enable the model-specific LAN port and configure the port VLAN ID.</p> <p>Use the <code>no</code> command to remove the specified port and VLAN settings.</p> <p><i>ap_lan_port</i>: the Ethernet LAN port on the managed AP, such as <code>lan1</code> or <code>lan2</code>.</p>
<pre>[no] lan-provision model {nwa5301-nj   wac6502d-e   wac6502d-s   wac6503d-s   wac6553d-e} ap_lan_port inactivate pvid &lt;1..4094&gt;</pre>	<p>Sets the model of the managed AP and disable the model-specific LAN port and configure the port VLAN ID.</p> <p>Use the <code>no</code> command to remove the specified port and VLAN settings.</p> <p><i>ap_lan_port</i>: the Ethernet LAN port on the managed AP, such as <code>lan1</code> or <code>lan2</code>.</p>
<pre>[no] lan-provision model {nwa5301-nj   wac6502d-e   wac6502d-s   wac6503d-s   wac6553d-e} vlan_interface activate vid &lt;1..4094&gt; join ap_lan_port {tag   untag} [ap_lan_port {tag   untag}] [ap_lan_port {tag   untag}]</pre>	<p>Sets the model of the managed AP, enable a VLAN and configure the VLAN ID. It also sets the Ethernet port(s) on the managed AP to be a member of the VLAN, and sets the port(s) to send packets with or without a VLAN tag.</p> <p>Use the <code>no</code> command to remove the specified port and VLAN settings.</p> <p><i>vlan_interface</i>: the name of the VLAN, such as <code>vlan0</code>.</p> <p><i>ap_lan_port</i>: the Ethernet LAN port on the managed AP, such as <code>lan1</code> or <code>lan2</code>.</p>
<pre>[no] lan-provision model {nwa5301-nj   wac6502d-e   wac6502d-s   wac6503d-s   wac6553d-e} vlan_interface inactivate vid &lt;1..4094&gt; join ap_lan_port {tag   untag} [ap_lan_port {tag   untag}] [ap_lan_port {tag   untag}]</pre>	<p>Sets the model of the managed AP, disable a VLAN and configure the VLAN ID. It also sets the Ethernet port(s) on the managed AP to be a member of the VLAN, and sets the port(s) to send packets with or without a VLAN tag.</p> <p>Use the <code>no</code> command to remove the specified port and VLAN settings.</p> <p><i>vlan_interface</i>: the name of the VLAN, such as <code>vlan0</code>.</p> <p><i>ap_lan_port</i>: the Ethernet LAN port on the managed AP, such as <code>lan1</code> or <code>lan2</code>.</p>
<pre>[no] load-balancing [slot1   slot2] activate</pre>	<p>Enables load balancing. Use the <code>no</code> parameter to disable it.</p> <p>Optionally specify a radio slot.</p>
<pre>load-balancing [slot1   slot2] alpha &lt;1..255&gt;</pre>	<p>Sets the load balancing alpha value.</p> <p>When the AP is balanced, then this setting delays a client's association with it by this number of seconds.</p> <p>Note: This parameter has been optimized for the Zyxel Device and should not be changed unless you have been specifically directed to do so by Zyxel support.</p>
<pre>load-balancing [slot1   slot2] beta &lt;1..255&gt;</pre>	<p>Sets the load balancing beta value.</p> <p>When the AP is overloaded, then this setting delays a client's association with it by this number of seconds.</p> <p>Note: This parameter has been optimized for the Zyxel Device and should not be changed unless you have been specifically directed to do so by Zyxel support.</p>

Table 17 Command Summary: AP Group (continued)

COMMAND	DESCRIPTION
load-balancing [slot1   slot2] kickInterval <1..255>	Enables the kickout feature for load balancing and also sets the kickout interval in seconds. While load balancing is enabled, the AP periodically disconnects stations at intervals equal to this setting.  This occurs until the load balancing threshold is no longer exceeded.
[no] load-balancing [slot1   slot2] kickout	Enables an overloaded AP to disconnect ("kick") idle clients or clients with noticeably weak connections.
load-balancing [slot1   slot2] liInterval <1..255>	Sets the interval in seconds that each AP communicates with the other APs in its range for calculating the load balancing algorithm.  Note: This parameter has been optimized for the Zyxel Device and should not be changed unless you have been specifically directed to do so by Zyxel support.
load-balancing [slot1   slot2] max sta <1..127>	If load balancing by the number of stations/wireless clients, this sets the maximum number of devices allowed to connect to a load-balanced AP.
load-balancing mode [slot1   slot2] {station   traffic   smart-classroom}	Enables load balancing based on either number of stations (also known as wireless clients) or wireless traffic on an AP.  station or traffic: once the threshold is crossed (either the maximum station numbers or with network traffic), the AP delays association request and authentication request packets from any new station that attempts to make a connection.  smart-classroom: the AP ignores association request and authentication request packets from any new station when the maximum number of stations is reached.
load-balancing [slot1   slot2] sigma <51..100>	Sets the load balancing sigma value.  This value is algorithm parameter used to calculate whether an AP is considered overloaded, balanced, or underloaded. It only applies to 'by traffic mode'.  Note: This parameter has been optimized for the Zyxel Device and should not be changed unless you have been specifically directed to do so by Zyxel support.
load-balancing [slot1   slot2] timeout <1..255>	Sets the length of time that an AP retains load balancing information it receives from other APs within its range.
load-balancing [slot1   slot2] traffic level {high   low   medium}	If load balancing by traffic threshold, this sets the traffic threshold level.
vlan <1..4094> {tag   untag}	Sets the management VLAN ID for the AP(s) in this group as well as whether packets sent to and from that VLAN ID are tagged or untagged.
show ap-group first-priority	Displays the name of the default AP group profile.
show ap-group-profile {all   ap_group_profile_name}	Displays the settings of the AP group profile(s).  all: Displays all profiles.  ap_group_profile_name: Displays the specified profile.
show ap-group-profile ap_group_profile_name load-balancing config	Displays the load balancing configuration of the specified AP group profile.

Table 17 Command Summary: AP Group (continued)

COMMAND	DESCRIPTION
<pre>show ap-group-profile   ap_group_profile_name lan-   provision interface {all   vlan     ethernet   ap_lan_port     vlan_interface} model {nwa5301-nj     wac6502d-e   wac6502d-s     wac6503d-s   wac6553d-e}</pre>	<p>Displays the LAN port and/or VLAN settings on the managed AP which is in the specified AP group and of the specified model.</p> <p><i>vlan_interface</i>: the name of the VLAN, such as vlan0.</p> <p><i>ap_lan_port</i>: the Ethernet LAN port on the managed AP, such as lan1 or lan2.</p>
<pre>show ap-group-profile   ap_group_profile_name lan-   provision model</pre>	<p>Shows the model name of the managed AP which belongs to the specified AP group.</p>
<pre>show ap-group-profile rule_count</pre>	<p>Displays how many AP group profiles have been configured on the Zyxel Device.</p>
<pre>ap-group-profile rename   ap_group_profile_name1   ap_group_profile_name2</pre>	<p>Gives an existing AP group profile (<i>ap_group_profile_name1</i>) a new name (<i>ap_group_profile_name2</i>).</p>

## 8.2.1 AP Group Examples

The following example shows you how to create an AP group profile (named "TEST") and configure the AP's first radio to work in repeater mode using the "default" radio profile and the "ZyMesh\_TEST" ZyMesh profile. It also adds the AP with the MAC address 00:a0:c5:01:23:45 to this AP group.

```
Router(config)# ap-group-profile TEST
Router(config-ap-group TEST)# slot1 repeater-ap default
Router(config-ap-group TEST)# exit
Router(config)# ap-group-member TEST member 00:a0:c5:01:23:45
Router(config)#
```

The following example shows you how to create an AP group profile (named GP1) and configure AP load balancing in "by station" mode. The maximum number of stations is set to 1.

```
Router(config)# ap-group-profile GP1
Router(config-ap-group GP1)# load-balancing mode station
Router(config-ap-group GP1)# load-balancing max sta 1
Router(config-ap-group GP1)# exit
Router(config)# show ap-group-profile GP1 load-balancing config
AP Group Profile:GP1
load balancing config:
Activate: yes
Kickout: no
Mode: station
Max-sta: 1
Traffic-level: high
Alpha: 5
Beta: 10
Sigma: 60
Timeout: 20
LIInterval: 10
KickoutInterval: 20
Router(config)#
```

The following example shows you how to create an AP group profile (named GP2) and configure AP load balancing in "by traffic" mode. The traffic level is set to low, and "disassociate station" is enabled.

```
Router(config)# ap-group-profile GP2
Router(config-ap-group GP2)# load-balancing mode traffic
Router(config-ap-group GP2)# load-balancing traffic level low
Router(config-ap-group GP2)# load-balancing kickout
Router(config-ap-group GP2)# exit
Router(config)# show ap-group-profile GP2 load-balancing config
AP Group Profile:GP2
load balancing config:
Activate: yes
Kickout: yes
Mode: traffic
Max-sta: 1
Traffic-level: low
Alpha: 5
Beta: 10
Sigma: 60
Timeout: 20
LIInterval: 10
KickoutInterval: 20
Router(config)#
```

The following example shows the settings and status of the VLAN(s) configured for the managed APs (NWA5301-NJ) in the default AP group.

```
Router(config)# show ap-group-profile default lan-provision interface vlan
model nwa5301-nj
No. Name           Active VID  Member
=====
1  vlan0           yes      1      lan1,lan2,lan3
Router(config)# show ap-group-profile default lan-provision interface vlan0
model nwa5301-nj
active: yes
interface name: vlan0
VID: 1
member: lan1&lan2&lan3
lan1_tag: untag
lan2_tag: untag
lan3_tag: untag
Router(config)#
```



The following example shows the status of Ethernet ports for the managed APs (NWA5301-NJ) in the default AP group. It also shows whether the lan1 port is enabled and what the port's VLAN ID is.

```
Router(config)# show ap-group-profile default lan-provision interface
ethernet model nwa5301-nj
No. Name           Active PVID
=====
1  uplink          yes   n/a
2  lan1            yes   1
3  lan2            yes   1
4  lan3            yes   1
Router(config)# show ap-group-profile default lan-provision interface lan1
model nwa5301-nj
Name              Active PVID
=====
lan1              yes    1
Router(config)#
```

# CHAPTER 9

## Wireless LAN Profiles

This chapter shows you how to configure wireless LAN profiles on your Zyxel Device.

### 9.1 Wireless LAN Profiles Overview

The managed Access Points designed to work explicitly with your Zyxel Device do not have on-board configuration files, you must create “profiles” to manage them. Profiles are preset configurations that are uploaded to the APs and which manage them. They include: Radio and Monitor profiles, SSID profiles, Security profiles, and MAC Filter profiles. Altogether, these profiles give you absolute control over your wireless network.

### 9.2 AP Radio & Monitor Profile Commands

The radio profile commands allow you to set up configurations for the radios onboard your various APs. The monitor profile commands allow you to set up monitor mode configurations that allow your APs to scan for other APs in the vicinity.

The following table identifies the values required for many of these commands. Other input values are discussed with the corresponding commands.

Table 18 Input Values for General Radio and Monitor Profile Commands

LABEL	DESCRIPTION
<i>radio_profile_name</i>	The radio profile name. You may use 1-31 alphanumeric characters, underscores ( <code>_</code> ), or dashes ( <code>-</code> ), but the first character cannot be a number. This value is case-sensitive.
<i>monitor_profile_name</i>	The monitor profile name. You may use 1-31 alphanumeric characters, underscores ( <code>_</code> ), or dashes ( <code>-</code> ), but the first character cannot be a number. This value is case-sensitive.
<i>interval</i>	Enters the dynamic channel selection interval time. The range is 10 ~ 1440 minutes.
<i>wlan_role</i>	Sets the wireless LAN radio operating mode. At the time of writing, you can use <code>ap</code> for Access Point.
<i>wireless_channel_2g</i>	Sets the 2 GHz channel used by this radio profile. The channel range is 1 ~ 14. Note: Your choice of channel may be restricted by regional regulations.
<i>wireless_channel_5g</i>	Sets the 5 GHz channel used by this radio profile. The channel range is 36 ~ 165. Note: Your choice of channel may be restricted by regional regulations.
<i>wlan_htcw</i>	Sets the HT channel width. Select either <code>20</code> , <code>20/40</code> or <code>20/40/80</code> .

Table 18 Input Values for General Radio and Monitor Profile Commands (continued)

LABEL	DESCRIPTION
<code>wlan_htgi</code>	Sets the HT guard interval. Select either long or short.
<code>chain_mask</code>	Sets the network traffic chain mask. The range is 1 ~ 7.
<code>wlan_power</code>	Sets the radio output power.
<code>scan_method</code>	Sets the radio's scan method while in Monitor mode. Select manual or auto.
<code>wlan_interface_index</code>	Sets the radio interface index number. The range is 1 ~ 8.
<code>ssid_profile</code>	Sets the associated SSID profile name. This name must be an existing SSID profile. You may use 1-31 alphanumeric characters, underscores ( <code>_</code> ), or dashes ( <code>-</code> ), but the first character cannot be a number. This value is case-sensitive.

The following table describes the commands available for radio and monitor profile management. You must use the `configure terminal` command to enter the configuration mode before you can use these commands.

Table 19 Command Summary: Radio Profile

COMMAND	DESCRIPTION
<code>show wlan-radio-profile {all   radio_profile_name}</code>	Displays the radio profile(s).  <i>all</i> : Displays all profiles.  <i>radio_profile_name</i> : Displays the specified profile.
<code>wlan-radio-profile rename radio_profile_name1 radio_profile_name2</code>	Gives an existing radio profile ( <i>radio_profile_name1</i> ) a new name ( <i>radio_profile_name2</i> ).
<code>[no] wlan-radio-profile radio_profile_name</code>	Enters configuration mode for the specified radio profile. Use the <i>no</i> parameter to remove the specified profile.
<code>2g-basic-speed speed</code>	
<code>2g-channel wireless_channel_2g</code>	Sets the broadcast band for this profile in the 2.4 GHz frequency range. The default is 6.
<code>2g-multicast-speed wlan_2g_support_speed</code>	When you disable multicast to unicast, use this command to set the data rate { 1.0   2.0   ... } in Mbps for 2.4 GHz multicast traffic.
<code>2g-wlan-rate-control rate_2g</code>	Sets the minimum data rate that 2.4GHz WiFi clients can connect at, in Mbps. At the time of write, allowed values are: 1, 2, 5, 6, 9, 11, 12, 18, 24, 36, 48, 54.  Increasing the minimum data rate can reduce network overhead and improve WiFi network performance in high density environments. However, WiFi clients that do not support the minimum data rate will not be able to connect to the AP.
<code>5g-basic-speed speed</code>	
<code>5g-channel wireless_channel_5g</code>	Sets the broadcast band for this profile in the 5 GHz frequency range. The default is 36.
<code>5g-multicast-speed wlan_5g_basic_speed</code>	When you disable multicast to unicast, use this command to set the data rate { 6.0   9.0   ... } in Mbps for 5 GHz multicast traffic.

Table 19 Command Summary: Radio Profile (continued)

COMMAND	DESCRIPTION
<code>5g-wlan-rate-control rate_5g</code>	<p>Sets the minimum data rate that 5Ghz WiFi clients can connect at, in Mbps. At the time of write, allowed values are: 6,9, 12, 18, 24, 36, 48, 54.</p> <p>Increasing the minimum data rate can reduce network overhead and improve WiFi network performance in high density environments. However, WiFi clients that do not support the minimum data rate will not be able to connect to the AP.</p>
<code>[no] activate</code>	Makes this radio profile active or inactive.
<code>[no] ampdu</code>	<p>Activates MPDU frame aggregation for this profile. Use the <code>no</code> parameter to disable it.</p> <p>Message Protocol Data Unit (MPDU) aggregation collects Ethernet frames along with their 802.11n headers and wraps them in a 802.11n MAC header. This method is useful for increasing bandwidth throughput in environments that are prone to high error rates.</p> <p>By default this is enabled.</p>
<code>limit-ampdu &lt; 100..65535&gt;</code>	<p>Sets the maximum frame size to be aggregated using MPDU.</p> <p>By default this is 50000.</p>
<code>subframe-ampdu &lt;2..64&gt;</code>	<p>Sets the maximum number of frames to be aggregated each time.</p> <p>By default this is 32.</p>
<code>[no] amsdu</code>	<p>Activates MPDU frame aggregation for this profile. Use the <code>no</code> parameter to disable it.</p> <p>Mac Service Data Unit (MSDU) aggregation collects Ethernet frames without any of their 802.11n headers and wraps the header-less payload in a single 802.11n MAC header. This method is useful for increasing bandwidth throughput. It is also more efficient than A-MPDU except in environments that are prone to high error rates.</p> <p>By default this is enabled.</p>
<code>limit-amsdu &lt;2290..4096&gt;</code>	<p>Sets the maximum frame size to be aggregated using MPDU.</p> <p>The default is 4096.</p>

Table 19 Command Summary: Radio Profile (continued)

COMMAND	DESCRIPTION
<code>band {2.4G   5G} band-mode {bg   bgn   a   ac   an   bgnax   anacax}</code>	<p>Sets the radio band (2.4 GHz or 5 GHz) and band mode for this profile. Band mode details:</p> <p>For 2.4 GHz, <code>bg</code> lets IEEE 802.11b and IEEE 802.11g clients associate with the AP.</p> <p>For 2.4 GHz, <code>bgn</code> lets IEEE 802.11b, IEEE 802.11g, and IEEE 802.11n clients associate with the AP.</p> <p>For 2.4 GHz, <code>bgnax</code> lets IEEE 802.11b, IEEE 802.11g, IEEE 802.11n, and IEEE802.11ax clients associate with the AP.</p> <p>For 5 GHz, <code>a</code> lets only IEEE 802.11a clients associate with the AP.</p> <p>For 5 GHz, <code>ac</code> lets IEEE 802.11a, IEEE 802.11n, and IEEE 802.11ac clients associate with the AP.</p> <p>For 5 GHz, <code>an</code> lets IEEE 802.11a and IEEE 802.11n clients associate with the AP.</p> <p>For 5 GHz, <code>anacax</code> lets IEEE 802.11a, IEEE 802.11n, IEEE 802.11ac, and IEEE802.11ax clients associate with the AP.</p>
<code>beacon-interval &lt;40..1000&gt;</code>	<p>Sets the beacon interval for this profile.</p> <p>When a wirelessly networked device sends a beacon, it includes with it a beacon interval. This specifies the time period before the device sends the beacon again. The interval tells receiving devices on the network how long they can wait in low-power mode before waking up to handle the beacon. This value can be set from 40ms to 1000ms. A high value helps save current consumption of the access point.</p> <p>The default is 100.</p>
<code>[no] block-ack</code>	Makes <code>block-ack</code> active or inactive. Use the <code>no</code> parameter to disable it.
<code>bss-color &lt;0~63&gt;</code>	Sets the BSS color of the AP, which distinguishes it from other nearby APs when they transmit over the same channel. Set it to 0 to automatically assign a BSS color.
<code>[no] disable-bss-color</code>	<p>Disables BSS coloring.</p> <p>Use the <code>no</code> command to enable BSS coloring.</p>
<code>ch-width wlan_htcw</code>	Sets the channel width for this profile.
<code>country-code country_code</code>	<p>Sets the country where the Zyxel Device is located/installed.</p> <p>The available channels vary depending on the country you selected. Be sure to select the correct/same country for both radios on an AP and all connected APs, in order to prevent roaming failure and interference to other systems.</p> <p><i>country_code</i>: 2-letter country-codes, such as TW, DE, or FR.</p>

Table 19 Command Summary: Radio Profile (continued)

COMMAND	DESCRIPTION
[no] ctsrts <0..2347>	<p>Sets or removes the RTS/CTS value for this profile.</p> <p>Use RTS/CTS to reduce data collisions on the wireless network if you have wireless clients that are associated with the same AP but out of range of one another. When enabled, a wireless client sends an RTS (Request To Send) and then waits for a CTS (Clear To Send) before it transmits. This stops wireless clients from transmitting packets at the same time (and causing data collisions).</p> <p>A wireless client sends an RTS for all packets larger than the number (of bytes) that you enter here. Set the RTS/CTS equal to or higher than the fragmentation threshold to turn RTS/CTS off.</p> <p>The default is 2347.</p>
[no] dcs activate	Starts dynamic channel selection to automatically find a less-used channel in an environment where there are many APs and there may be interference. Use the <code>no</code> parameter to turn it off.
dcs 2g-selected-channel <i>2.4g_channels</i>	Specifies the channels that are available in the 2.4 GHz band when you manually configure the channels an AP can use.
dcs 5g-selected-channel <i>5g_channels</i>	Specifies the channels that are available in the 5 GHz band when you manually configure the channels an AP can use.
dcs dcs-2g-method {auto manual}	Sets the AP to automatically search for available channels or manually configure the channels the AP uses in the 2.4 GHz band.
dcs dcs-5g-method {auto manual}	Sets the AP to automatically search for available channels or manually configure the channels the AP uses in the 5 GHz band.
dcs client-aware {enable disable}	When enabled, this ensures that an AP will not change channels as long as a client is connected to it. If disabled, the AP may change channels regardless of whether it has clients connected to it or not.
dcs channel-deployment {3-channel 4-channel}	<p>Sets either a 3-channel deployment or a 4-channel deployment.</p> <p>In a 3-channel deployment, the AP running the scan alternates between the following channels: 1, 6, and 11.</p> <p>In a 4-channel deployment, the AP running the scan alternates between the following channels: 1, 4, 7, and 11 (FCC) or 1, 5, 9, and 13 (ETSI).</p> <p>Sets the option that is applicable to your region. (Channel deployment may be regulated differently between countries and locales.)</p>
dcs dfs-aware {enable disable}	<p>Enable this to allow an AP to avoid phase DFS channels below the 5 GHz spectrum.</p> <p>Note: This feature is automatically disabled when Zero-Wait DFS is enabled.</p>
dcs mode {interval schedule}	Sets the AP to use DCS at the end of the specified time interval or at a specific time on selected days of the week.
dcs schedule <hh:mm> {mon tue wed thu fri sat sun}	Sets what time of day (in 24-hour format) the AP starts to use DCS on the specified day(s) of the week.

Table 19 Command Summary: Radio Profile (continued)

COMMAND	DESCRIPTION
<code>dcx sensitivity-level {high medium  low}</code>	Sets how sensitive DCS is to radio channel changes in the vicinity of the AP running the scan.
<code>dcx time-interval interval</code>	Sets the interval that specifies how often DCS should run.
<code>description description</code>	Sets the description of the profile. You may use up to 60 alphanumeric characters, underscores ( <code>_</code> ), or dashes ( <code>-</code> ).
<code>[no] disable-dfs-switch</code>	Makes the DFS switch active or inactive. By default this is inactive.
<code>dot11-preamble {long short}</code>	
<code>[no] dot11n-disable-coexistence</code>	Fixes the channel bandwidth as 40 MHz. The <code>no</code> command has the AP automatically choose 40 MHz if all the clients support it or 20 MHz if some clients only support 20 MHz.
<code>dtim-period &lt;1..255&gt;</code>	Sets the DTIM period for this profile.  Delivery Traffic Indication Message (DTIM) is the time period after which broadcast and multicast packets are transmitted to mobile clients in the Active Power Management mode. A high DTIM value can cause clients to lose connectivity with the network. This value can be set from 1 to 255.  The default is 1.
<code>[no] force-mu-mimo</code>	
<code>[no] frag &lt;256..2346&gt;</code>	Sets or removes the fragmentation value for this profile.  The threshold (number of bytes) for the fragmentation boundary for directed messages. It is the maximum data fragment size that can be sent.  The default is 2346.
<code>guard-interval wlan_htgi</code>	Sets the guard interval for this profile.  The default for this is <i>short</i> .
<code>[no] htprotect</code>	Activates HT protection for this profile. Use the <code>no</code> parameter to disable it.  By default, this is disabled.
<code>[no] ignore-country-ie</code>	Prevents the AP from broadcasting a country code, also called a country Information Element (IE), in beacon frames. This makes the AP incompatible with 802.11d networks and devices. The <code>no</code> command allows the AP to broadcast the country code.  802.11d is a WiFi network specification that allows an AP to broadcast a country code to WiFi clients. The country code tells clients where the AP is located.  Note: Run this command if WiFi clients are unable to connect to the AP because of an incompatible country code.
<code>max-sw-retries &lt;0..10&gt;</code>	

Table 19 Command Summary: Radio Profile (continued)

COMMAND	DESCRIPTION
[no] multicast-to-unicast	<p>"Multicast to unicast" broadcasts wireless multicast traffic to all wireless clients as unicast traffic to provide more reliable transmission. The data rate changes dynamically based on the application's bandwidth requirements. Although unicast provides more reliable transmission of the multicast traffic, it also produces duplicate packets.</p> <p>The <code>no</code> command turns multicast to unicast off to send wireless multicast traffic at the rate you specify with the <code>2g-multicast-speed</code> or <code>5g-multicast-speed</code> command.</p>
[no] nol-channel-block	<p>Enables or disables temporary DFS channel blacklisting. If enabled, the AP will block a DFS channel if it detects a radar signal within that range.</p> <p>Note: This feature is automatically disabled when Zero-Wait DFS is enabled.</p>
output-power wlan_power	Sets the output power (between 0 to 30 dBm) for the radio in this profile.
pn-check-thres <0..100>	
[no] reject-legacy-station	
role wlan_role	Sets the profile's wireless LAN radio operating mode.
rsssi-dbm <-20~-76>	When using the RSSI threshold, set a minimum client signal strength for connecting to the AP. -20 dBm is the strongest signal you can require and -76 is the weakest.
rsssi-interval (1..86400>	
rsssi-kickout <-20~-105>	<p>Sets a minimum kick-off signal strength. When a wireless client's signal strength is lower than the specified threshold, the Zyxel Device disconnects the wireless client from the AP.</p> <p>-20 dBm is the strongest signal you can require and -105 is the weakest.</p>
rsssi-optype <0-3>	
rsssi-privilegetime	
[no] rsssi-retry	<p>Allows a wireless client to try to associate with the AP again after it is disconnected due to weak signal strength.</p> <p>Use the <code>no</code> parameter to disallow it.</p>
rsssi-retrycount <1~100>	Sets the maximum number of times a wireless client can attempt to re-connect to the AP.
[no] rsssi-thres	Sets whether or not to use the Received Signal Strength Indication (RSSI) threshold to ensure wireless clients receive good throughput. This allows only wireless clients with a strong signal to connect to the AP.
rsssi-verifytime	
rx-mask chain_mask	Sets the incoming chain mask rate.
schedule schedule_object	Sets the radio profile to be activate according to the schedule defined by the specified schedule object.
[no] ssid-profile wlan_interface_index ssid_profile	Assigns an SSID profile to this radio profile. Requires an existing SSID profile. Use the <code>no</code> parameter to disable it.
subframe-ampdu <2..64>	



Table 19 Command Summary: Radio Profile (continued)

COMMAND	DESCRIPTION
[no] suppress-retry-rts	
tx-mask <i>chain_mask</i>	Sets the outgoing chain mask rate.
wireless-health monitor act-lock-time	
wireless-health monitor inactivate	
wireless-health monitor interval	
wireless-health monitor issue-list	
[no] zero-wait-dfs	<p>Enables or disables zero-wait DFS (Dynamic Frequency Selection) on the AP.</p> <p>Note: Zero-wait DFS is only supported on certain AP models, such as the WAX650S.</p> <p>DFS is a channel WiFi allocation scheme that allows APs to use channels in the 5Ghz band normally reserved for radar. Before using a DFS channel, an AP must ensure that no radar present by performing a Channel Availability Check (CAC). This check takes 1-10 minutes, depending on the country in which the AP is located.</p> <p>Zero-Wait DFS allows an AP to provide network services to WiFi clients using a primary 5Ghz radio, while simultaneously checking DFS channels for the presence of radar using a secondary 5Ghz radio. If no radar is detected on a DFS channel, the AP adds it to a list of cleared channels. The AP can then switch the primary radio to any cleared DFS channel without having to wait 1-10 minutes for a Channel Availability Check.</p> <p>Note: When zero-wait DFS is enabled, 5Ghz DFS Aware (<i>dfs dfs-aware</i>) and Blacklist DFS Channels (<i>no1-channel-block</i>) are automatically disabled on the AP.</p>
exit	Exits configuration mode for this profile.
storm-control ethernet ap <i>mac_address</i>	<p>Enables Ethernet storm control and then enters the Ethernet storm control sub-command mode for the specified radio profile.</p> <p>Ethernet storm control prevents WiFi clients from receiving excessive broadcast or multicast traffic sent from wired clients in the same subnet.</p>
[no] broadcast	Enables or disables broadcast storm control, which drops broadcast packets from ingress traffic if the traffic rate exceeds the configured maximum rate.
broadcast pps <1-10000>	Sets the maximum allowed rate for broadcast traffic, in packets per second.
[no] multicast	Enables or disables multicast storm control, which drops multicast packets from ingress traffic if the traffic rate exceeds the configured maximum rate.
multicast pps <1-10000>	Sets the maximum allowed rate for multicast traffic, in packets per second.

Table 19 Command Summary: Radio Profile (continued)

COMMAND	DESCRIPTION
<code>exit</code>	Exits configuration mode for this profile.
<code>no storm-control ethernet ap mac_address</code>	Disables Ethernet broadcast and multicast storm control, and removes all Ethernet storm control settings for the specified AP.
<code>storm-control wireless ap mac_address</code>	Enables wireless storm control and then enters the wireless storm control sub-command mode for the specified AP.  Wireless storm control prevents wired clients from receiving excessive broadcast or multicast traffic sent from WiFi clients in the same subnet.  Note: To enable wireless storm control, Remote AP must be enabled on the AP and the AP must be running firmware version 6.20 or later.
<code>[no] broadcast</code>	Enables or disables broadcast storm control, which drops broadcast packets from ingress traffic if the traffic rate exceeds the configured maximum rate.
<code>broadcast pps &lt;1-10000&gt;</code>	Sets the maximum allowed rate for broadcast traffic, in packets per second.
<code>[no] multicast</code>	Enables or disables multicast storm control, which drops multicast packets from ingress traffic if the traffic rate exceeds the configured maximum rate.
<code>multicast pps &lt;1-10000&gt;</code>	Sets the maximum allowed rate for multicast traffic, in packets per second.
<code>exit</code>	Exits configuration mode for this profile.
<code>no storm-control wireless ap mac_address</code>	Disables wireless broadcast and multicast storm control, and removes all wireless storm control settings for the specified AP.
<code>show storm-control ethernet ap mac_address</code>	Displays broadcast/multicast storm control settings on the specified AP.
<code>show wlan-monitor-profile {all   monitor_profile_name}</code>	Displays all monitor profiles or just the specified one.
<code>wlan-monitor-profile rename monitor_profile_name1 monitor_profile_name2</code>	Gives an existing monitor profile ( <i>monitor_profile_name1</i> ) a new name ( <i>monitor_profile_name2</i> ).
<code>[no] wlan-monitor-profile monitor_profile_name</code>	Enters configuration mode for the specified monitor profile. Use the <i>no</i> parameter to remove the specified profile.
<code>[no] activate</code>	Makes this profile active or inactive.  By default, this is enabled.
<code>country-code country_code</code>	Sets the country where the Zyxel Device is located/installed.  The available channels vary depending on the country you selected. Be sure to select the correct/same country for both radios on an AP and all connected APs, in order to prevent roaming failure and interference to other systems.  <i>country_code</i> : 2-letter country-codes, such as TW, DE, or FR.
<code>scan-method scan_method</code>	Sets the channel scanning method for this profile.
<code>[no] 2g-scan-channel wireless_channel_2g</code>	Sets the broadcast band for this profile in the 2.4 Ghz frequency range. Use the <i>no</i> parameter to disable it.

Table 19 Command Summary: Radio Profile (continued)

COMMAND	DESCRIPTION
[no] 5g-scan-channel <i>wireless_channel_5g</i>	Sets the broadcast band for this profile in the 5 GHz frequency range. Use the <i>no</i> parameter to disable it.
scan-dwell <100..1000>	Sets the duration in milliseconds that the device using this profile scans each channel.
exit	Exits configuration mode for this profile.

## 9.2.1 AP Radio & Monitor Profile Commands Example

The following example shows you how to set up the radio profile named 'RADIO01', activate it, and configure it to use the following settings:

- 2.4G band with channel 6
- channel width of 20MHz
- a DTIM period of 2
- a beacon interval of 100ms
- AMPDU frame aggregation enabled
- an AMPDU buffer limit of 65535 bytes
- an AMPDU subframe limit of 64 frames
- AMSDU frame aggregation enabled
- an AMSDU buffer limit of 4096
- block acknowledgement enabled
- a short guard interval
- an output power of 100%

It will also assign the SSID profile labeled 'default' in order to create WLAN VAP (wlan-1-1) functionality within the radio profile.

```
Router(config)# wlan-radio-profile RADIO01
Router(config-profile-radio)# activate
Router(config-profile-radio)# band 2.4G band-mode bgn
Router(config-profile-radio)# 2g-channel 6
Router(config-profile-radio)# ch-width 20/40
Router(config-profile-radio)# dtim-period 2
Router(config-profile-radio)# beacon-interval 100
Router(config-profile-radio)# ampdu
Router(config-profile-radio)# limit-ampdu 65535
Router(config-profile-radio)# subframe-ampdu 64
Router(config-profile-radio)# amsdu
Router(config-profile-radio)# limit-amsdu 4096
Router(config-profile-radio)# block-ack
Router(config-profile-radio)# guard-interval short
Router(config-profile-radio)# tx-mask 5
Router(config-profile-radio)# rx-mask 7
Router(config-profile-radio)# output-power 21dBm
Router(config-profile-radio)# ssid-profile 1 default
```

## 9.3 SSID Profile Commands

The following table identifies the values required for many of these commands. Other input values are discussed with the corresponding commands.

Table 20 Input Values for General SSID Profile Commands

LABEL	DESCRIPTION
<i>ssid_profile_name</i>	The SSID profile name. You may use 1-31 alphanumeric characters, underscores ( <code>_</code> ), or dashes ( <code>-</code> ), but the first character cannot be a number. This value is case-sensitive.
<i>ssid</i>	The SSID broadcast name. You may use 1-32 alphanumeric characters, underscores ( <code>_</code> ), or dashes ( <code>-</code> ). This value is case-sensitive.
<i>wlan_qos</i>	Sets the type of QoS the SSID should use.  <i>disable</i> : Turns off QoS for this SSID.  <i>wmm</i> : Turns on QoS for this SSID. It automatically assigns Access Categories to packets as the device inspects them in transit.  <i>wmm_be</i> : Assigns the "best effort" Access Category to all traffic moving through the SSID regardless of origin.  <i>wmm_bk</i> : Assigns the "background" Access Category to all traffic moving through the SSID regardless of origin.  <i>wmm_vi</i> : Assigns the "video" Access Category to all traffic moving through the SSID regardless of origin.  <i>wmm_vo</i> : Assigns the "voice" Access Category to all traffic moving through the SSID regardless of origin.
<i>vlan_iface</i>	The VLAN interface name of the controller (in this case, it is Zyxel Device). The maximum VLAN interface number is product-specific; for the Zyxel Device, the number is 512.
<i>securityprofile</i>	Assigns an existing security profile to the SSID profile. You may use 1-31 alphanumeric characters, underscores ( <code>_</code> ), or dashes ( <code>-</code> ), but the first character cannot be a number. This value is case-sensitive.
<i>macfilterprofile</i>	Assigns an existing MAC filter profile to the SSID profile. You may use 1-31 alphanumeric characters, underscores ( <code>_</code> ), or dashes ( <code>-</code> ), but the first character cannot be a number. This value is case-sensitive.
<i>description2</i>	Sets the description of the profile. You may use up to 60 alphanumeric characters, underscores ( <code>_</code> ), or dashes ( <code>-</code> ). This value is case-sensitive.

The following table describes the commands available for SSID profile management. You must use the `configure terminal` command to enter the configuration mode before you can use these commands.

Table 21 Command Summary: SSID Profile

COMMAND	DESCRIPTION
<code>show wlan-ssid-profile {all / ssid_profile_name}</code>	Displays the SSID profile(s).  <i>all</i> : Displays all profiles for the selected operating mode.  <i>ssid_profile_name</i> : Displays the specified profile for the selected operating mode.
<code>wlan-ssid-profile rename ssid_profile_name1 ssid_profile_name2</code>	Gives an existing SSID profile ( <i>ssid_profile_name1</i> ) a new name ( <i>ssid_profile_name2</i> ).

Table 21 Command Summary: SSID Profile (continued)

COMMAND	DESCRIPTION
[no] wlan-ssid-profile <i>ssid_profile_name</i>	Enters configuration mode for the specified SSID profile. Use the <i>no</i> parameter to remove the specified profile.
[no] bandselect balance-ratio <1..8>	Sets a ratio of the wireless clients using the 5 GHz band to the wireless clients using the 2.4 GHz band. Use the <i>no</i> parameter to turn off this feature.
bandselect check-sta-interval <1..60000>	Sets how often (in seconds) the AP checks and deletes old wireless client data.
bandselect drop-authentication <1..16>	Sets how many authentication request from a client to a 2.4GHz Wi-Fi network is ignored during the specified timeout period.
bandselect drop-probe-request <1..32>	Sets how many probe request from a client to a 2.4GHz Wi-Fi network is ignored during the specified timeout period.
bandselect min-sort-interval <1..60000>	Sets the minimum interval (in seconds) at which the AP sorts the wireless client data when the client queue is full.
bandselect mode {disable   force   standard}	<p>To improve network performance and avoid interference in the 2.4 GHz frequency band, you can enable this feature to use the 5 GHz band first. You should set 2.4GHz and 5 GHz radio profiles to use the same SSID and security settings.</p> <p>Note: The managed APs must be dual-band capable.</p> <p><i>disable</i>: to turn off this feature.</p> <p><i>force</i>: to have the wireless clients always connect to an SSID using the 5 GHz band. Connections to an SSID using the 2.4GHz band are not allowed. It is recommended you select this option when the AP and wireless clients can function in either frequency band.</p> <p><i>standard</i>: to have the AP try to connect the wireless clients to the same SSID using the 5 GHz band. Connections to an SSID using the 2.4GHz band are still allowed.</p>
[no] bandselect stop-threshold <10..20>	Sets the threshold number of the connected wireless clients at which the AP disables the band select feature. Use the <i>no</i> parameter to turn off this feature.
bandselect time-out-force <1..255>	Sets the timeout period (in seconds) within which the AP accepts probe or authentication requests to a 2.4GHz Wi-Fi network when the band select mode is set to <i>force</i> .
bandselect time-out-period <1..255>	Sets the timeout period (in seconds) within which the AP drops the specified number of probe or authentication requests to a 2.4GHz Wi-Fi network.
bandselect time-out-standard <1..255>	Sets the timeout period (in seconds) within which the AP accepts probe or authentication requests to a 2.4GHz Wi-Fi network when the band select mode is set to <i>standard</i> .
[no] block-intra	<p>Enables intra-BSSID traffic blocking. Use the <i>no</i> parameter to disable it in this profile.</p> <p>By default this is disabled.</p>
data-forward localbridge	<p>Sets the data forwarding mode used by the SSID to localbridge mode.</p> <p>In this mode, all of the wireless station's traffic is routed through the associated AP's gateway and tagged with the VLAN ID set by command <i>vlan-id</i>.</p> <p>This is the default data forwarding mode.</p>

Table 21 Command Summary: SSID Profile (continued)

COMMAND	DESCRIPTION
<code>data-forward tunnel interface</code>	<p>Sets the data forwarding mode used by the SSID to tunnel mode.</p> <p>In this mode, all of the wireless station's traffic is routed through the Zyxel Device via the specified interface.</p> <p>Note: The interface must be a VLAN or internal Ethernet interface. The interface cannot be a member of a bridge.</p>
<code>downlink-rate-limit data_rate</code>	Sets the maximum incoming transmission data rate (either in mbps or kbps) on a per-station basis.
<code>[no] hide</code>	<p>Prevents the SSID from being publicly broadcast. Use the <code>no</code> parameter to re-enable public broadcast of the SSID in this profile.</p> <p>By default this is disabled.</p>
<code>[no] macfilter macfilterprofile</code>	<p>Assigns the specified MAC filtering profile to this SSID profile. Use the <code>no</code> parameter to remove it.</p> <p>By default, no MAC filter is assigned.</p>
<code>qos wlan_qos</code>	Sets the type of QoS used by this SSID.
<code>security securityprofile</code>	Assigns the specified security profile to this SSID profile.
<code>ssid</code>	<p>Sets the SSID. This is the name visible on the network to wireless clients. Enter up to 32 characters, spaces and underscores are allowed.</p> <p>The default SSID is 'ZyXEL'.</p>
<code>[no] ssid-schedule</code>	Enables the SSID schedule. Use the <code>no</code> parameter to disable the SSID schedule.
<code>{mon tue wed thu fri sat sun} {disable   enable} &lt;hh:mm&gt; &lt;hh:mm&gt;</code>	<p>Sets whether the SSID is enabled or disabled on each day of the week. This also specifies the hour and minute (in 24-hour format) to set the time period of each day during which the SSID is enabled/enabled.</p> <p>&lt;hh:mm&gt; &lt;hh:mm&gt;: If you set both start time and end time to 00:00, it indicates a whole day event.</p> <p>Note: The end time must be larger than the start time.</p>
<code>uplink-rate-limit data_rate</code>	Sets the maximum outgoing transmission data rate (either in mbps or kbps) on a per-station basis.
<code>vlan-id &lt;1..4094&gt;</code>	<p>Applies to each SSID profile that uses <code>localbridge</code>. If the VLAN ID is equal to the AP's native VLAN ID then traffic originating from the SSID is not tagged.</p> <p>The default VLAN ID is 1.</p>
<code>exit</code>	Exits configuration mode for this profile.

## 9.3.1 SSID Profile Example

The following example creates an SSID profile with the name 'ZyXEL'. It makes the assumption that both the security profile (SECURITY01) and the MAC filter profile (MACFILTER01) already exist.

```
Router(config)# wlan-ssid-profile SSID01
Router(config-ssid-radio)# ssid ZyXEL
Router(config-ssid-radio)# qos wmm
Router(config-ssid-radio)# data-forward localbridge
Router(config-ssid-radio)# security SECURITY01
Router(config-ssid-radio)# macfilter MACFILTER01
Router(config-ssid-radio)# exit
Router(config)#
```

## 9.4 Security Profile Commands

The following table identifies the values required for many of these commands. Other input values are discussed with the corresponding commands.

Table 22 Input Values for General Security Profile Commands

LABEL	DESCRIPTION
<i>security_profile_name</i>	The security profile name. You may use 1-31 alphanumeric characters, underscores ( <code>_</code> ), or dashes ( <code>-</code> ), but the first character cannot be a number. This value is case-sensitive.
<i>wep_key</i>	Sets the WEP key encryption strength. Select either <i>64bit</i> or <i>128bit</i> .
<i>wpa_key</i>	Sets the WPA/WPA2 pre-shared key in ASCII. You may use 8-63 alphanumeric characters. This value is case-sensitive.
<i>wpa_key_64</i>	Sets the WPA/WPA2 pre-shared key in HEX. You must use 64 alphanumeric characters.
<i>secret</i>	Sets the shared secret used by your network's RADIUS server.
<i>auth_method</i>	The authentication method used by the security profile.

The following table describes the commands available for security profile management. You must use the `configure` terminal command to enter the configuration mode before you can use these commands.

Table 23 Command Summary: Security Profile

COMMAND	DESCRIPTION
<code>show wlan-security-profile {all   <i>security_profile_name</i>}</code>	Displays the security profile(s).  <i>all</i> : Displays all profiles for the selected operating mode.  <i>security_profile_name</i> : Displays the specified profile for the selected operating mode.
<code>wlan-security-profile rename <i>security_profile_name1</i> <i>security_profile_name2</i></code>	Gives existing security profile ( <i>security_profile_name1</i> ) a new name, ( <i>security_profile_name2</i> ).
<code>[no] wlan-security-profile <i>security_profile_name</i></code>	Enters configuration mode for the specified security profile. Use the <code>no</code> parameter to remove the specified profile.
<code>[no] accounting interim-interval &lt;1..1440&gt;</code>	Sets the time interval for how often the AP is to send an interim update message with current client statistics to the accounting server. Use the <code>no</code> parameter to clear the interval setting.

Table 23 Command Summary: Security Profile (continued)

COMMAND	DESCRIPTION
[no] accounting interim-update	Sets the AP to send accounting update messages to the accounting server at the specified interval. Use the <code>no</code> parameter to disable it.
description <i>description</i>	Sets the description for the profile. You may use up to 60 alphanumeric characters, underscores ( <code>_</code> ), or dashes ( <code>-</code> ). This value is case-sensitive
[no] dot11r activate	Turns on IEEE 802.11r fast roaming on the AP. Use the <code>no</code> parameter to turn it off.
[no] dot11r over-the-ds activate	Sets the clients to communicate with the target AP through the current AP. The communication between the client and the target AP is carried in frames between the client and the current AP, and is then sent to the target AP through the wired Ethernet connection.  Use the <code>no</code> parameter to have the clients communicate directly with the target AP.
[no] dot1x-eap	Enables 802.1x secure authentication. Use the <code>no</code> parameter to disable it.
[no] dot11w	Data frames in 802.11 WLANs can be encrypted and authenticated with WEP, WPA or WPA2. But 802.11 management frames, such as beacon/probe response, association request, association response, de-authentication and disassociation are always unauthenticated and unencrypted. IEEE 802.11w Protected Management Frames allows APs to use the existing security mechanisms (encryption and authentication methods defined in IEEE 802.11i WPA/WPA2) to protect management frames. This helps prevent wireless DoS attacks.  Enables management frame protection (MFP) to add security to 802.11 management frames. Use the <code>no</code> parameter to disable it.
dot11w-op <1..2>	Sets whether wireless clients have to support management frame protection in order to access the wireless network.  1: if you do not require the wireless clients to support MFP. Management frames will be encrypted if the clients support MFP.  2: wireless clients must support MFP in order to join the AP's wireless network.
eap {external   internal auth_method}	Sets the 802.1x authentication method.
group-key <30..30000>	Sets the interval (in seconds) at which the AP updates the group WPA/WPA2 encryption key.  The default is 3000.
idle <30..30000>	Sets the idle interval (in seconds) that a client can be idle before authentication is discontinued.  The default is 300.
[no] internal-eap-proxy activate	Allows the Zyxel Device to act as a proxy server and forward the authentication packets to the connected RADIUS server.  Use the <code>no</code> parameter to disable it.



Table 23 Command Summary: Security Profile (continued)

COMMAND	DESCRIPTION
[no] mac-auth activate	MAC authentication has the AP use an external server to authenticate wireless clients by their MAC addresses. Users cannot get an IP address if the MAC authentication fails. The <code>no</code> parameter turns it off.  RADIUS servers can require the MAC address in the wireless client's account (username/password) or Calling Station ID RADIUS attribute.
mac-auth auth-method <i>auth_method</i>	Sets the authentication method for MAC authentication.
mac-auth case account {upper / lower}	Sets the case (upper or lower) the external server requires for using MAC addresses as the account username and password.  For example, use <code>mac-auth case account upper</code> and <code>mac-auth delimiter account dash</code> if you need to use a MAC address formatted like 00-11-AC-01-A0-11 as the username and password.
mac-auth case calling-station-id {upper / lower}	Sets the case (upper or lower) the external server requires for letters in MAC addresses in the Calling Station ID RADIUS attribute.
mac-auth delimiter account {colon / dash / none}	Specify the separator the external server uses for the two-character pairs within MAC addresses used as the account username and password.  For example, use <code>mac-auth case account upper</code> and <code>mac-auth delimiter account dash</code> if you need to use a MAC address formatted like 00-11-AC-01-A0-11 as the username and password.
mac-auth delimiter calling-station-id {colon / dash / none}	Select the separator the external server uses for the pairs in MAC addresses in the Calling Station ID RADIUS attribute.
mode {none   enhanced-open   wep   wpa2   wpa2-mix   wpa3}	Sets the security mode for this profile.
[no] reauth <30..30000>	Sets the interval (in seconds) between authentication requests. The default is 0.
[no] server-acct <1..2> activate	Enables user accounting through an external server. Use the <code>no</code> parameter to disable.
server-acct <1..2> ip address <i>ipv4_address</i> port <1..65535> secret <i>secret</i>	Sets the IPv4 address, port number and shared secret of the external accounting server.
no server-acct <1..2>	Clears the specified user accounting setting.
[no] server-auth <1..2> activate	Activates server authentication for the account. The <code>no</code> command deactivates authentication.
server-auth <1..2> ip address <i>ipv4_address</i> port <1..65535> secret <i>secret</i>	Sets the IPv4 address, port number and shared secret of the RADIUS server to be used for authentication.
no server-auth <1..2>	Clears the server authentication setting.
[no] transition-mode	Enables backward compatibility when used with WPA3 or Enhanced Open security mode. WPA3 falls back to WPA2, while Enhanced Open falls back to open (none).

Table 23 Command Summary: Security Profile (continued)

COMMAND	DESCRIPTION
<code>wep &lt;64   128&gt; default-key &lt;1..4&gt;</code>	<p>Sets the WEP encryption strength (<i>64</i> or <i>128</i>) and the default key value (<i>1 ~ 4</i>).</p> <p>If you select WEP-64 enter 10 hexadecimal digits in the range of "A-F", "a-f" and "0-9" (for example, 0x11AA22BB33) for each Key used; or enter 5 ASCII characters (case sensitive) ranging from "a-z", "A-Z" and "0-9" (for example, MyKey) for each Key used.</p> <p>If you select WEP-128 enter 26 hexadecimal digits in the range of "A-F", "a-f" and "0-9" (for example, 0x00112233445566778899AABBCC) for each Key used; or enter 13 ASCII characters (case sensitive) ranging from "a-z", "A-Z" and "0-9" (for example, MyKey12345678) for each Key used.</p> <p>You can save up to four different keys. Enter the <code>default-key</code> (<i>1 ~ 4</i>) to save your WEP to one of those four available slots.</p>
<code>wep-auth-type {open   share}</code>	Sets the authentication key type to either <i>open</i> or <i>share</i> .
<code>wpa-encrypt {tkip   aes   auto}</code>	<p>Sets the WPA/WPA2 encryption cipher type.</p> <p><i>auto</i>: This automatically chooses the best available cipher based on the cipher in use by the wireless client that is attempting to make a connection.</p> <p><i>tkip</i>: This is the Temporal Key Integrity Protocol encryption method added later to the WEP encryption protocol to further secure. Not all wireless clients may support this.</p> <p><i>aes</i>: This is the Advanced Encryption Standard encryption method, a newer more robust algorithm than TKIP. Not all wireless clients may support this.</p>
<code>wpa-psk {wpa_key / wpa_key_64}</code>	Sets the WPA/WPA2 pre-shared key.
<code>[no] wpa2-preauth</code>	<p>Enables pre-authentication to allow wireless clients to switch APs without having to re-authenticate their network connection. The RADIUS server puts a temporary PMK Security Authorization cache on the wireless clients. It contains their session ID and a pre-authorized list of viable APs.</p> <p>Use the <code>no</code> parameter to disable this.</p>
<code>exit</code>	Exits configuration mode for this profile.

### 9.4.1 Security Profile Example

The following example creates a security profile with the name 'SECURITY01'.

```
Router(config)# wlan-security-profile SECURITY01
Router(config-security-profile)# mode wpa2
Router(config-security-profile)# wpa-encrypt aes
Router(config-security-profile)# wpa-psk 12345678
Router(config-security-profile)# idle 3600
Router(config-security-profile)# reauth 1800
Router(config-security-profile)# group-key 1800
Router(config-security-profile)# exit
Router(config)#
```

## 9.4.2 SSID and Security Profiles Example

This is an example of creating different WiFi network groups for different types of users, such as guests or employees at your company. You can configure different SSIDs and security modes for each group.

Follow the steps below to set up a wireless network for your company guest. Use the parameters in the table below.

Table 24 SSID and Security Profiles Settings Example

	<b>GUEST</b>
SSID	Guest
Security Mode	WPA2
Pre-Share Key	guest123

- 1 Create an SSID profile. Set the profile name as **Guest**. Enter sub-command mode for this profile.

```
Router# configure terminal
Router(config)# wlan-ssid-profile Guest
Router(config-wlan-ssid Guest)#
```

- 2 Set the SSID as **Guest**. Exit the sub-command mode.

```
Router(config-wlan-ssid Guest)# ssid Guest
Router(config-wlan-ssid Guest)# exit
Router(config)#
```

- 3 Create a security profile. Set the profile name as **GuestSecurity**. Enter sub-command mode for this profile.

```
Router(config)# wlan-security-profile GuestSecurity
Router(config-wlan-security GuestSecurity)#
```

- 4 Set the security mode to **WPA2**. Set the pre-shared key to **guest123**. Exit the sub-command mode.

```
Router(config-wlan-security GuestSecurity)# mode wpa2
Router(config-wlan-security GuestSecurity)# wpa-psk guest123
Router(config-wlan-security GuestSecurity)# exit
Router(config)#
```

- 5 Enter the **Guest** SSID profile sub command mode. Apply the **GuestSecurity** security profile to this SSID.

```
Router(config)# wlan-ssid-profile Guest
Router(config-wlan-ssid Guest)# security GuestSecurity
```

## 9.5 MAC Filter Profile Commands

The following table identifies the values required for many of these commands. Other input values are discussed with the corresponding commands.

Table 25 Input Values for General MAC Filter Profile Commands

LABEL	DESCRIPTION
<i>macfilter_profile_name</i>	The MAC filter profile name. You may use 1-31 alphanumeric characters, underscores ( <code>_</code> ), or dashes ( <code>-</code> ), but the first character cannot be a number. This value is case-sensitive.
<i>description2</i>	Sets the description of the profile. You may use up to 60 alphanumeric characters, underscores ( <code>_</code> ), or dashes ( <code>-</code> ). This value is case-sensitive.

The following table describes the commands available for security profile management. You must use the `configure` terminal command to enter the configuration mode before you can use these commands.

Table 26 Command Summary: MAC Filter Profile

COMMAND	DESCRIPTION
<code>show wlan-macfilter-profile {all   <i>macfilter_profile_name</i>}</code>	Displays the security profile(s). <i>all</i> : Displays all profiles for the selected operating mode. <i>macfilter_profile_name</i> : Displays the specified profile for the selected operating mode.
<code>wlan-macfilter-profile rename <i>macfilter_profile_name1</i> <i>macfilter_profile_name2</i></code>	Gives an existing security profile ( <i>macfilter_profile_name1</i> ) a new name ( <i>macfilter_profile_name2</i> ).
<code>[no] wlan-macfilter-profile <i>macfilter_profile_name</i></code>	Enters configuration mode for the specified MAC filter profile. Use the <i>no</i> parameter to remove the specified profile.
<code>filter-action {allow   deny}</code>	Permits the wireless client with the MAC addresses in this profile to connect to the network through the associated SSID; select <i>deny</i> to block the wireless clients with the specified MAC addresses. The default is set to <i>deny</i> .
<code>[no] <i>sta_mac</i> description <i>description2</i></code>	Sets the description of the wireless client with this MAC address. Enter up to 60 characters. Spaces and underscores allowed.
<code>exit</code>	Exits configuration mode for this profile.

### 9.5.1 MAC Filter Profile Example

The following example creates a MAC filter profile with the name 'MACFILTER01'.

```
Router(config)# wlan-macfilter-profile MACFILTER01
Router(config-macfilter-profile)# filter-action deny
Router(config-macfilter-profile)# 01:02:03:04:05:06 description MAC01
Router(config-macfilter-profile)# 01:02:03:04:05:07 description MAC02
Router(config-macfilter-profile)# 01:02:03:04:05:08 description MAC03
Router(config-macfilter-profile)# exit
Router(config)#
```

## 9.6 ZyMesh Profile Commands

ZyMesh is a ZyXEL-proprietary feature. In a ZyMesh, multiple managed APs form a WDS (Wireless Distribution System) to expand the wireless network and provide services or forward traffic between the Zyxel Device and wireless clients. ZyMesh also allows the Zyxel Device to use CAPWAP to automatically update the configuration settings on the managed APs (in repeater mode) through wireless connections. The managed APs (in repeater mode) are provisioned hop by hop. The managed APs in a WDS or ZyMesh must use the same SSID, channel number and pre-shared key. A managed AP can be either a root AP or repeater in a ZyMesh.

Note: All managed APs should be connected to the Zyxel Device directly to get the configuration file before being deployed to build a ZyMesh/WDS. Ensure you restart the managed AP after you change its operating mode using the `wlan-radio-profile radio_profile_name` role commands.

- Root AP: a managed AP that can transmit and receive data from the Zyxel Device via a wired Ethernet connection.
- Repeater: a managed AP that transmit and/or receive data from the Zyxel Device via a wireless connection through a root AP.

Note: When managed APs are deployed to form a ZyMesh/WDS for the first time, the root AP must be connected to an AP controller (the Zyxel Device).

The maximum number of hops (the repeaters between a wireless client and the root AP) you can have in a ZyMesh varies according to how many wireless clients a managed AP can support.

Note: A ZyMesh/WDS link with more hops has lower throughput.

Note: When the wireless connection between the root AP and the repeater is up, in order to prevent bridge loops, the repeater would not be able to transmit data through its Ethernet port(s). The repeater then could only receive power from a PoE device if you use PoE to provide power to the managed AP via an 8-ping Ethernet cable.

The following table identifies the values required for many of these commands. Other input values are discussed with the corresponding commands.

Table 27 Input Values for General ZyMesh Profile Commands

LABEL	DESCRIPTION
<code>zymesh_profile_name</code>	The ZyMesh profile name. You may use 1-31 alphanumeric characters, underscores ( <code>_</code> ), or dashes ( <code>-</code> ), but the first character cannot be a number. This value is case-sensitive.

The following table describes the commands available for ZyMesh profile management. You must use the `configure terminal` command to enter the configuration mode before you can use these commands.

Table 28 Command Summary: ZyMesh Profile

COMMAND	DESCRIPTION
<code>show zymesh ap info</code>	Displays the number of currently connected/offline ZyMesh APs.
<code>show zymesh link info {repeater-ap   root-ap}</code>	Displays the ZyMesh/WDS traffic statistics between the managed APs.  repeater-a: the managed AP is acting as a repeater in a ZyMesh.  root-ap: the managed AP is acting as a root AP in a ZyMesh.

Table 28 Command Summary: ZyMesh Profile (continued)

COMMAND	DESCRIPTION
<code>show zymesh provision-group</code>	Displays the current ZyMesh Provision Group MAC address in the Zyxel Device.
<code>show zymesh-profile {all   zymesh_profile_name}</code>	Displays the ZyMesh profile settings. <i>all</i> : Displays all profiles. <i>zymesh_profile_name</i> : Displays the specified profile.
<code>zymesh-profile rename zymesh_profile_name1 zymesh_profile_name2</code>	Gives an existing radio profile ( <i>zymesh_profile_name1</i> ) a new name ( <i>zymesh_profile_name2</i> ).
<code>[no] zymesh-profile zymesh_profile_name</code>	Enters configuration mode for the specified ZyMesh profile. Use the <i>no</i> parameter to remove the specified profile.
<code>psk psk</code>	Sets a pre-shared key of between 8 and 63 case-sensitive ASCII characters (including spaces and symbols) or 64 hexadecimal characters. The key is used to encrypt the wireless traffic between the APs.
<code>ssid ssid</code>	Sets the SSID with which you want the managed AP to connect to a root AP or repeater to build a ZyMesh link.  Note: The ZyMesh SSID is hidden in the outgoing beacon frame so a wireless device cannot obtain the SSID through scanning using a site survey tool.
<code>exit</code>	Exits configuration mode for this profile.
<code>zymesh provision-group ac_mac</code>	Enters the ZyMesh Provision Group MAC address of the primary AP controller in your network to use this Zyxel Device to replace the primary AP controller.

# CHAPTER 10

## Rogue AP

This chapter shows you how to set up Rogue Access Point (AP) detection and containment.

### 10.1 Rogue AP Detection Overview

Rogue APs are wireless access points operating in a network's coverage area that are not under the control of the network's administrators, and can potentially open holes in the network security. Attackers can take advantage of a rogue AP's weaker (or non-existent) security to gain illicit access to the network, or set up their own rogue APs in order to capture information from wireless clients.

Conversely, a friendly AP is one that the Zyxel Device network administrator regards as non-threatening. This does not necessarily mean the friendly AP must belong to the network managed by the Zyxel Device; rather, it is any unmanaged AP within range of the Zyxel Device's own wireless network that is allowed to operate without being contained. This can include APs from neighboring companies, for example, or even APs maintained by your company's employees that operate outside of the established network.

### 10.2 Rogue AP Detection Commands

The following table identifies the values required for many of these commands. Other input values are discussed with the corresponding commands.

Table 29 Input Values for Rogue AP Detection Commands

LABEL	DESCRIPTION
<i>ap_mac</i>	Specifies the MAC address (in XX:XX:XX:XX:XX:XX format) of the AP to be added to either the rogue AP or friendly AP list. The <code>no</code> command removes the entry.
<i>description2</i>	Sets the description of the AP. You may use 1-60 alphanumeric characters, underscores ( <code>_</code> ), or dashes ( <code>-</code> ). This value is case-sensitive.

The following table describes the commands available for rogue AP detection. You must use the `configure terminal` command to enter the configuration mode before you can use these commands.

Table 30 Command Summary: Rogue AP Detection

COMMAND	DESCRIPTION
<code>rogue-ap detection</code>	Enters sub-command mode for rogue AP detection.
<code>[no] activate</code>	Activates rogue AP detection. Use the <code>no</code> parameter to deactivate rogue AP detection.

Table 30 Command Summary: Rogue AP Detection (continued)

COMMAND	DESCRIPTION
<code>rogue-ap ap_mac description2</code>	Sets the device that owns the specified MAC address as a rogue AP. You can also assign a description to this entry on the rogue AP list.
<code>no rogue-ap ap_mac</code>	Removes the device that owns the specified MAC address from the rogue AP list.
<code>friendly-ap ap_mac description2</code>	Sets the device that owns the specified MAC address as a friendly AP. You can also assign a description to this entry on the friendly AP list.
<code>no friendly-ap ap_mac</code>	Removes the device that owns the specified MAC address from the friendly AP list.
<code>monitoring flush</code>	Removes all detected APs from the rogue AP list.
<code>exit</code>	Exits configuration mode for rogue AP detection.
<code>show rogue-ap detection monitoring</code>	Displays a table of detected APs and information about them, such as their MAC addresses, when they were last seen, and their SSIDs, to name a few.
<code>show rogue-ap detection list {rogue   friendly  all}</code>	Displays the specified rogue/friendly/all AP list.
<code>show rogue-ap detection status</code>	Displays whether rogue AP detection is on or off.
<code>show rogue-ap detection info</code>	Displays a summary of the number of detected devices from the following categories: rogue, friendly, ad-hoc, unclassified, and total.

## 10.2.1 Rogue AP Detection Examples

This example sets the device associated with MAC address 00:13:49:11:11:11 as a rogue AP, and the device associated with MAC address 00:13:49:11:11:22 as a friendly AP. It then removes MAC address from the rogue AP list with the assumption that it was misidentified.

```
Router(config)# rogue-ap detection
Router(config-detection)# rogue-ap 00:13:49:11:11:11 rogue
Router(config-detection)# friendly-ap 00:13:49:11:11:22 friendly
Router(config-detection)# no rogue-ap 00:13:49:11:11:11
Router(config-detection)# exit
```

This example displays the rogue AP detection list.

```
Router(config)# show rogue-ap detection list rogue
no. mac description
contain
=====
1 00:13:49:18:15:5A
0
```



This example shows the friendly AP detection list.

```
Router(config)# show rogue-ap detection list friendly
no.    mac                description
=====
1      11:11:11:11:11:11      third floor
2      00:13:49:11:22:33
3      00:13:49:00:00:05
4      00:13:49:00:00:01
5      00:0D:0B:CB:39:33     dept1
```

This example shows the combined rogue and friendly AP detection list.

```
Router(config)# show rogue-ap detection list all
no.    role                mac                description
=====
1      friendly-ap         11:11:11:11:11:11  third floor
2      friendly-ap         00:13:49:11:22:33
3      friendly-ap         00:13:49:00:00:05
4      friendly-ap         00:13:49:00:00:01
5      friendly-ap         00:0D:0B:CB:39:33  dept1
6      rogue-ap            00:13:49:18:15:5A
```

This example shows both the status of rogue AP detection and the summary of detected APs.

```
Router(config)# show rogue-ap detection status
rogue-ap detection status: on

Router(config)# show rogue-ap detection info
rogue ap: 1
friendly ap: 4
adhoc: 4
unclassified ap: 0
total devices: 0
```

## 10.3 Rogue AP Containment Overview

These commands enable rogue AP containment. You can use them to isolate a device that is flagged as a rogue AP. They are global in that they apply to all managed APs on the network (all APs utilize the same containment list, but only APs set to monitor mode can actively engage in containment of rogue APs). This means if we add a MAC address of a device to the containment list, then every AP on the network will respect it.

Note: Containing a rogue AP means broadcasting unviable login data at it, preventing legitimate wireless clients from connecting to it. This is a kind of Denial of Service attack.

## 10.4 Rogue AP Containment Commands

The following table identifies the values required for many of these commands. Other input values are discussed with the corresponding commands.

Table 31 Input Values for Rogue AP Containment Commands

LABEL	DESCRIPTION
<i>ap_mac</i>	Specifies the MAC address (in XX:XX:XX:XX:XX:XX format) of the AP to be contained. The <code>no</code> command removes the entry.

The following table describes the commands available for rogue AP containment. You must use the `configure terminal` command to enter the configuration mode before you can use these commands.

Table 32 Command Summary: Rogue AP Containment

COMMAND	DESCRIPTION
<code>rogue-ap containment</code>	Enters sub-command mode for rogue AP containment.
<code>[no] activate</code>	Activates rogue AP containment. Use the <code>no</code> parameter to deactivate rogue AP containment.
<code>[no] contain ap_mac</code>	Isolates the device associated with the specified MAC address. Use the <code>no</code> parameter to remove this device from the containment list.
<code>exit</code>	Exits configuration mode for rogue AP containment.
<code>show rogue-ap containment config</code>	Displays whether rogue AP containment is enabled or not.
<code>show rogue-ap containment list</code>	Displays the rogue AP containment list.

### 10.4.1 Rogue AP Containment Example

This example contains the device associated with MAC address 00:13:49:11:11:12 then displays the containment list for confirmation.

```
Router(config)# rogue-ap containment
Router(config-containment)# activate
Router(config-containment)# contain 00:13:49:11:11:12
Router(config-containment)# exit
Router(config)# show rogue-ap containment list
no.    mac
=====
1      00:13:49:11:11:12
```

# CHAPTER 11

## Wireless Health

### 11.1 Wireless Health Overview

This chapter describes the wireless health commands. Wireless health is the APs wireless network performance in Zyxel Device networks. Wireless health state is defined by the times the APs have to send the packets before the packets are sent out successfully. The more times the AP has to resend the packets, the poorer the state of wireless health the AP is in.

You can improve wireless network performance by doing the following:

- Enable Dynamic Channel Selection (DCS) to select a radio channel with least interference.
- Enable client steering to use a stronger WiFi signal.
- Change channel bandwidth to reduce radio interference from other wireless devices.

### 11.2 Wireless Health Commands

The following table describes the commands available for the wireless health.

Table 33 Command Summary: Wireless Health

COMMAND	DESCRIPTION
<code>show wireless-health-action</code>	Displays the wireless health settings.
<code>show ap-info top 10 alert {2.4G   5G   all}</code>	Displays the top 10 APs that are in poor states of wireless health for the most times.
<code>show sta-info top 10 alert {2.4G   5G   all}</code>	Displays how many times the client is in a poor state of wireless health.

The following table describes the commands available for the wireless health. You must use the `configure terminal` commands to enter the configuration mode before you can use the configuration commands. Commands that do not have IPv6 specified in the description are for IPv4.

Table 34 Command Summary: Wireless Health

COMMAND	DESCRIPTION
<code>[no] wlan-radio-profile radio profile name</code>	Enters configuration mode for the specified radio profile. Use the <code>no</code> command to remove the specified profile.
<code>[no] wireless-health {activate   radio   sta}</code>	<p><code>activate</code>: Enables <b>Wireless Health</b>. Use the <code>no</code> command to disable this feature.</p> <p><code>radio</code>: Configure wireless health settings for the APs in Zyxel Device networks. See <a href="#">Section 11.2.1 on page 101</a> for more information on radio settings commands.</p> <p><code>sta</code>: Configure wireless health settings for the wireless clients which are connected to the supported APs in Zyxel Device networks. See <a href="#">Section 11.2.1 on page 101</a> for more information on station settings commands.</p>

## 11.2.1 Wireless Health Radio and Station Settings

The following table describes the configuration commands available for the wireless health radio and station. You must be in the configuration mode to configure a specified radio profile before you can use the commands. Commands that do not have IPv6 specified in the description are for IPv4.

Table 35 Command Summary: Wireless Health

COMMAND	DESCRIPTION
<pre>wireless-health radio {action   act-lock-time &lt;1...1440&gt;   recovery-threshold &lt;10...1000&gt;  act-threshold &lt;10...1000&gt;  data- collect-interval &lt;0...120&gt;}</pre>	<p><b>action:</b> Configure the actions taken to improve the AP wireless network performance. See <a href="#">Section 11.2.2 on page 102</a> for more information on radio actions commands.</p> <p><b>act-lock-time:</b> Configure the length of time in seconds the Zyxel Device cannot implement the action you set to the APs in a poor state of wireless health. For example, if you set the time to 30, the Zyxel Device can only have the AP choose a channel that has the least interference (DCS) or change the AP channel bandwidth from 80MHz to 20MHz (adaptive channel width) once even if the Zyxel Device detects that the AP is in a poor state of wireless health more than once within 30 seconds.</p> <p><b>recovery-threshold:</b> Configure the length of time in seconds the AP changes the channel bandwidth from 20 MHz to 80 MHz. Use this command if you set the action to <code>downgrade_cw</code>, which will change the AP channel bandwidth from 80MHz to 20 MHz. See <a href="#">Section 11.2.2 on page 102</a> for more information.</p> <p><b>act-threshold:</b> Configure how many times the AP has to resend the packets will trigger the action you set. For example, if you set the threshold to 10, the Zyxel Device will have the AP choose a channel that has the least interference (DCS) or change the AP channel bandwidth from 80MHz to 20MHz (adaptive channel width) if the AP has to try 10 times before it can send out packets successfully.</p> <p><b>data-collect-interval:</b> Configure the time period over which the AP wireless health state is recorded.</p>
<pre>wireless-health sta {action   act-lock-time &lt;1...1440&gt;  act- threshold &lt;10...1000&gt;  data- collect-interval &lt;0...120&gt;}</pre>	<p><b>action:</b> Configure the actions taken to improve the wireless network performance of clients that are connected to the Zyxel Device supported APs. See <a href="#">Section 11.2.2 on page 102</a> for more information on radio actions commands.</p> <p><b>act-lock-time:</b> Configure the length of time in seconds the Zyxel Device cannot implement the action you set to the clients in a poor state of wireless health. For example, if you set the time to 30, the Zyxel Device can only steer the wireless clients connected to an AP with a poor signal to an AP with a strong signal once even if the Zyxel Device detects that the AP is in a poor state of wireless health more than once within 30 seconds.</p> <p><b>act-threshold:</b> Configure how many times the AP the clients is connected to has to resend the packets will trigger the action you set. For example, if you set the threshold to 10, the Zyxel Device will steer the wireless clients to an AP with a strong signal if the AP the clients is connected to has to try 10 times before it can send out packets successfully.</p> <p><b>data-collect-interval:</b> Configure the time period over which the client wireless health state is recorded.</p>

## 11.2.2 Wireless Health Radio and Station Actions

The following table describes the action commands available for the wireless health radio and station. You must be in the configuration mode to configure a specified radio profile before you can use the commands. Commands that do not have IPv6 specified in the description are for IPv4.

Table 36 Command Summary: Wireless Health

COMMAND	DESCRIPTION
<pre>wireless-health radio action {dcs_now   downgrade_cw   none}</pre>	<p><b>dcs_now</b>: Sets the action to <code>dcs_now</code> to have the AP scan and choose a radio channel that has the least interference.</p> <p><b>downgrade_cw</b>: Sets the action to <code>downgrade_cw</code> to have the AP change the channel bandwidth from 80 MHz to 20 MHz to reduce the radio interference with other APs.</p> <p><b>none</b>: Sets the action to <code>none</code> to have no action taken when the AP is in a poor state of health.</p>
<pre>wireless-health sta action {kick_sta   none}</pre>	<p><b>kick_sta</b>: Sets the action to <code>kick_sta</code> to have the Zyxel Device try to steer the wireless clients connected to an AP with a poor signal to an AP with a strong signal every 30 minutes.</p> <p><b>none</b>: Sets the action to <code>none</code> to have no action taken when the client is in a poor state of wireless health.</p>

# CHAPTER 12

## Wireless Frame Capture

This chapter shows you how to configure and use wireless frame capture on the Zyxel Device.

### 12.1 Wireless Frame Capture Overview

Troubleshooting wireless LAN issues has always been a challenge. Wireless sniffer tools like Ethereal can help capture and decode packets of information, which can then be analyzed for debugging. It works well for local data traffic, but if your devices are spaced increasingly farther away then it often becomes correspondingly difficult to attempt remote debugging. Complicated wireless packet collection is arguably an arduous and perplexing process. The wireless frame capture feature in the Zyxel Device can help.

This chapter describes the wireless frame capture commands, which allows a network administrator to capture wireless traffic information and download it to an Ethereal/Tcpdump compatible format packet file for analysis.

### 12.2 Wireless Frame Capture Commands

The following table identifies the values required for many of these commands. Other input values are discussed with the corresponding commands.

Table 37 Input Values for Wireless Frame Capture Commands

LABEL	DESCRIPTION
<i>ip_address</i>	The IP address of the Access Point (AP) that you want to monitor. Enter a standard IPv4 IP address (for example, 192.168.1.2).
<i>mon_dir_size</i>	The total combined size (in kbytes) of all files to be captured. The maximum you can set is 50 megabytes (52428800 bytes.)
<i>file_name</i>	The file name prefix for each captured file. The default prefix is monitor while the default file name is monitor.dump.  You can use 1-31 alphanumeric characters, underscores or dashes but the first character cannot be a number. This string is case sensitive.

The following table describes the commands available for wireless frame capture. You must use the `configure terminal` command to enter the configuration mode before you can use these commands.

Table 38 Command Summary: Wireless Frame Capture

COMMAND	DESCRIPTION
<code>frame-capture configure</code>	Enters sub-command mode for wireless frame capture.
<code>src-ip {add del} {ipv4_address / local}</code>	Sets or removes the IPv4 address of an AP controlled by the Zyxel Device that you want to capture wireless network traffic going through the AP interfaces. You can use this command multiple times to add additional IPs to the list.
<code>file-prefix file_name</code>	Sets the file name prefix for each captured file. Enter up to 31 alphanumeric characters. Spaces and underscores are not allowed.
<code>files-size mon_dir_size</code>	Sets the total combined size (in kbytes) of all files to be captured.
<code>exit</code>	Exits configuration mode for wireless frame capture.
<code>[no] frame-capture activate</code>	Starts wireless frame capture. Use the <code>no</code> parameter to turn it off.
<code>show frame-capture status</code>	Displays whether frame capture is running or not.
<code>show frame-capture config</code>	Displays the frame capture configuration.

## 12.2.1 Wireless Frame Capture Examples

This example configures the wireless frame capture parameters for an AP located at IP address 192.168.1.2.

```
Router(config)# frame-capture configure
Router(frame-capture)# src-ip add 192.168.1.2
Router(frame-capture)# file-prefix monitor
Router(frame-capture)# files-size 1000
Router(frame-capture)# exit
Router(config)#
```

This example shows frame capture status and configuration.

```
Router(config)# show frame-capture status
capture status: off

Router(config)# show frame-capture config
capture source: 192.168.1.2
file prefix: monitor
file size: 1000
```

## 12.2.2 Remote Packet Capture

Remote packet capture allows you to capture network traffic going through an AP, and output the captured packets to a packet analyzer (also known as network or protocol analyzer) such as Wireshark.



You must use the `configure terminal` command to enter the configuration mode before you can use these commands.

Note: To start, stop, and configure remote packet capture on an AP, log into the Web Configurator and then go to **Maintenance > Diagnostics > Packet Capture > Remote Capture**.

Table 39 Command Summary: Remote Capture

<b>COMMAND</b>	<b>DESCRIPTION</b>
<code>show capwap ap all lite2</code>	Lists all connected APs, and shows whether they support packet capture and remote packet capture.
<code>show remote-capture status</code>	Shows whether remote capture is currently running on the Zyxel Device.

# CHAPTER 13

# Dynamic Channel Selection

This chapter shows you how to configure and use dynamic channel selection on the Zyxel Device.

## 13.1 DCS Overview

Dynamic Channel Selection (DCS) is a feature that allows an AP to automatically select the radio channel upon which it broadcasts by passively listening to the area around it and determining what channels are currently being broadcast on by other devices.

When numerous APs broadcast within a given area, they introduce the possibility of heightened radio interference, especially if some or all of them are broadcasting on the same radio channel. This can make accessing the network potentially rather difficult for the stations connected to them. If the interference becomes too great, then the network administrator must open his AP configuration options and manually change the channel to one that no other AP is using (or at least a channel that has a lower level of interference) in order to give the connected stations a minimum degree of channel interference.

## 13.2 DCS Commands

See [Section 9.2 on page 74](#) for detailed information about how to configure DCS settings in a radio profile.

The following table describes the commands available for dynamic channel selection. You must use the `configure terminal` command to enter the configuration mode before you can use these commands.

Table 40 Command Summary: DCS

COMMAND	DESCRIPTION
<code>dcs now {ap_mac   profile_name}</code>	Sets the managed AP to scan for and select an available channel immediately.

# CHAPTER 14

## Auto-Healing

This chapter shows you how to configure auto-healing settings.

### 14.1 Auto-Healing Overview

Auto-healing allows you to extend the wireless service coverage area of the managed APs when one of the managed APs fails.

### 14.2 Auto-Healing Commands

The following table identifies the values required for many of these commands. Other input values are discussed with the corresponding commands.

Table 41 Input Values for Auto-Healing Commands

LABEL	DESCRIPTION
<i>interval</i>	Enters the auto-healing interval time. The range is 5 ~ 30 minutes.

The following table describes the commands available for auto-healing. You must use the `configure terminal` command to enter the configuration mode before you can use these commands.

Table 42 Command Summary: Auto-Healing

COMMAND	DESCRIPTION
<code>[no] auto-healing activate</code>	Turns on the auto-healing feature. Use the <code>no</code> parameter to turn it off.
<code>auto-healing healing-interval interval</code>	Sets the interval that specifies how often the managed APs scan their neighborhoods and report the status of neighbor APs to the AP controller (Zyxel Device).  An AP is considered "failed" if the AP controller obtains the same scan result that the AP is missing from the neighbor list of other APs three times.
<code>auto-healing healing-threshold</code>	Sets a minimum signal strength. A managed AP is added to the neighbor lists only when the signal strength of the AP is stronger than the specified threshold.

Table 42 Command Summary: Auto-Healing (continued)

COMMAND	DESCRIPTION
<code>auto-healing power-threshold &lt;-50~-80&gt;</code>	Sets a power threshold (in dBm). This value is used to calculate the power level ( <code>power-threshold + margin</code> ) to which the neighbor APs of the failed AP increase their output power in order to extend their wireless service coverage areas.  When the failed AP is working again, its neighbor APs return their output power to the original level.
<code>auto-healing margin</code>	Enters a number from 0 to 9. This value is used to calculate the power level ( <code>power-threshold + margin</code> ) to which the neighbor APs of the failed AP increase their output power in order to extend their wireless service coverage areas.
<code>auto-healing update</code>	Sets all managed APs to immediately scan their neighborhoods three times in a row and update their neighbor lists to the AP controller (Zykel Device).
<code>show auto-healing config</code>	Displays the current auto-healing configuration.

## 14.2.1 Auto-Healing Examples

This example enables auto-healing and sets the power level (in dBm) to which the neighbor APs of the failed AP increase their output power.

```
Router(config)# auto-healing activate
Router(config)# auto-healing power-threshold -70
Router(config)# show auto-healing config
auto-healing activate: yes
auto-healing interval: 10
auto-healing power threshold: -70 dBm
auto-healing healing threshold: -85 dBm
auto-healing margin: 0
Router(config)#
```

# CHAPTER 15

## LEDs

This chapter describes two features that controls the LEDs of the managed APs connected to your Zyxel Device - Locator and Suppression.

### 15.1 LED Suppression Mode

The LED Suppression feature allows you to control how the LEDs of an AP behave after it's ready. The default LED suppression setting of the AP is different depending on your AP model.

Note: When the AP is booting or performing firmware upgrade, the LEDs will light regardless of the setting in LED suppression.

### 15.2 LED Suppression Commands

Use these commands to set how you want the LEDs to behave after the device is ready. You must use the `configure terminal` command before you can use these commands.

Table 43 LED Suppression Commands

COMMAND	DESCRIPTION
<code>led_suppress ap_mac_address enable</code>	Sets the LEDs of the specified AP to turn off after it's ready.
<code>led_suppress ap_mac_address disable</code>	Sets the LEDs of the specified AP to stay lit after the Zyxel Device is ready.
<code>show led_suppress ap_mac_address status</code>	Displays whether LED suppression mode is enabled or disabled on the specified AP.

#### 15.2.1 LED Suppression Commands Example

The following example activates LED suppression mode on the AP with the MAC address 00:a0:c5:01:23:45 and displays the settings.

```
Router(config)# led_suppress 00:a0:c5:01:23:45 enable
Router(config)# show led_suppress 00:a0:c5:01:23:45 status
Suppress Mode Status : Enable
Router(config)#
```

## 15.3 LED Locator

The LED locator feature identifies the location of the WAC AP among several devices in the network. You can run this feature and set a timer.

## 15.4 LED Locator Commands

Use these commands to run the LED locator feature. You must use the `configure terminal` command before you can use these commands.

Table 44 LED Locator Commands

COMMAND	DESCRIPTION
<code>led_locator ap_mac_address on</code>	Enables the LED locator function on the specified AP. It will show the actual location of the AP among several devices in the network.
<code>led_locator ap_mac_address off</code>	Disables the LED locator function on the specified AP.
<code>led_locator ap_mac_address blink-timer &lt;1..60&gt;</code>	Sets a time interval between 1 and 60 minutes to stop the locator LED from blinking on the specified AP.  Note: You should run this command before enabling the LED locator function.
<code>show led_locator ap_mac_address status</code>	Displays whether LED locator function is enabled on the specified AP and the timer setting.

### 15.4.1 LED Locator Commands Example

The following example turns on the LED locator feature on the AP with the MAC address 00:a0:c5:01:23:45, sets how long the locator LED stays blinking, and also displays the settings.

```
Router(config)# led_locator 00:a0:c5:01:23:45 blink-timer 5
Router(config)# led_locator 00:a0:c5:01:23:45 on
Router(config)# show led_locator 00:a0:c5:01:23:45 status
Locator LED Status : ON
Locator LED Time : 5
Router(config)#
```

# CHAPTER 16

## Interfaces

This chapter shows you how to use interface-related commands.

### 16.1 Interface Overview

In general, an interface has the following characteristics.

- An interface is a logical entity through which (layer-3) packets pass.
- An interface is bound to a physical port or another interface.
- Many interfaces can share the same physical port.
- An interface is bound to at most one zone.
- Many interfaces can belong to the same zone.
- Layer-3 virtualization (IP alias, for example) is a kind of interface.

Some characteristics do not apply to some types of interfaces.

#### 16.1.1 Types of Interfaces

You can create several types of interfaces in each Zyxel Device model. The types supported vary by Zyxel Device model.

- **Port groups** create a hardware connection between physical ports at the layer-2 (data link, MAC address) level.
- **Ethernet interfaces** are the foundation for defining other interfaces and network policies. RIP and OSPF are also configured in these interfaces.
- **VLAN interfaces** receive and send tagged frames. The Zyxel Device automatically adds or removes the tags as needed. Each VLAN can only be associated with one Ethernet interface.
- **Bridge interfaces** create a software connection between Ethernet or VLAN interfaces at the layer-2 (data link, MAC address) level. Unlike port groups, bridge interfaces can take advantage of some security features in the Zyxel Device. You can also assign an IP address and subnet mask to the bridge.
- **PPPoE/PPTP interfaces** support Point-to-Point Protocols (PPP). ISP accounts are required for PPPoE/PPTP interfaces.
- **Cellular interfaces** are for 3G WAN connections via a connected 3G device.
- **Virtual interfaces** (IP alias) provide additional routing information in the Zyxel Device. There are three types: **virtual Ethernet interfaces**, **virtual VLAN interfaces**, and **virtual bridge interfaces**.
- **VPN Tunnel Interface (VTI)** encrypts or decrypts IPv4 traffic from or to the interface according to the IP routing table.
- **Link Aggregation Group (LAG) interfaces** combine multiple physical Ethernet interfaces into a single logical interface, thus increasing uplink bandwidth and availability in the event a link goes down.

- **Trunks** manage load balancing between interfaces.

Port groups, and trunks have a lot of characteristics that are specific to each type of interface. These characteristics are listed in the following tables and discussed in more detail farther on.

Table 45 Characteristics of Ethernet, VLAN, Bridge, PPPoE/PPTP, and Virtual Interface (for some Zyxel Device models)

CHARACTERISTICS	ETHERNET	VLAN	BRIDGE	PPPOE/PPTP	VIRTUAL
Name*	gex	vlanx	brx	pppx	**
IP Address Assignment					
static IP address	Yes	Yes	Yes	Yes	Yes
DHCP client	Yes	Yes	Yes	Yes	No
routing metric	Yes	Yes	Yes	Yes	Yes
Interface Parameters					
bandwidth restrictions	Yes	Yes	Yes	Yes	Yes
packet size (MTU)	Yes	Yes	Yes	Yes	No
data size (MSS)	Yes	Yes	Yes	Yes	No
traffic prioritization	Yes	Yes	Yes	Yes	No
DHCP					
DHCP server	Yes	Yes	Yes	No	No
DHCP relay	Yes	Yes	Yes	No	No
Ping Check	Yes	Yes	Yes	Yes	No

\* - The format of interface names is strict. Each name consists of 2-4 letters (interface type), followed by a number (x, limited by the maximum number of each type of interface). For example, Ethernet interface names are ge1, ge2, ge3, ...; VLAN interfaces are vlan0, vlan1, vlan2, ...; and so on.

\*\* - The names of virtual interfaces are derived from the interfaces on which they are created. For example, virtual interfaces created on Ethernet interface ge1 are called ge1:1, ge1:2, and so on. Virtual interfaces created on VLAN interface vlan2 are called vlan2:1, vlan2:2, and so on. You cannot specify the number after the colon(:) in the web configurator; it is a sequential number. You can specify the number after the colon if you use the CLI to set up a virtual Interface Parameters

Table 46 Ethernet, VLAN, Bridge, PPP, and Virtual Interface Characteristics (For other Zyxel Device models)

CHARACTERISTICS	ETHERNET	ETHERNET	ETHERNET	VLAN	BRIDGE	PPP	VIRTUAL
Name*	opt	wan1, wan2	lan1, ext-wlan, dmz	vlanx	brx	pppx	**
Configurable Zone	Yes	No	No	Yes	Yes	No	No
IP Address Assignment							
Static IP address	Yes	Yes	Yes	Yes	Yes	Yes	Yes
DHCP client	Yes	Yes	No	Yes	Yes	Yes	No
Routing metric	Yes	Yes	Yes	Yes	Yes	Yes	Yes
Interface Parameters							
Bandwidth restrictions	Yes	Yes	Yes	Yes	Yes	Yes	Yes
Packet size (MTU)	Yes	Yes	Yes	Yes	Yes	Yes	No
Data size (MSS)	Yes	Yes	Yes	Yes	Yes	Yes	No
DHCP							



Table 46 Ethernet, VLAN, Bridge, PPP, and Virtual Interface Characteristics (For other Zyxel Device models) (continued)

CHARACTERISTICS	ETHERNET	ETHERNET	ETHERNET	VLAN	BRIDGE	PPP	VIRTUAL
DHCP server	Yes	No	Yes	Yes	Yes	No	No
DHCP relay	Yes	No	Yes	Yes	Yes	No	No
Connectivity Check	Yes	Yes	No	Yes	Yes	Yes	No

\* - Each name consists of 2-4 letters (interface type), followed by a number (*x*). For most interfaces, *x* is limited by the maximum number of the type of interface. For VLAN interfaces, *x* is defined by the number you enter in the VLAN name field. For example, Ethernet interface names are wan1, wan2, opt, lan1, ext-wlan, dmz; VLAN interfaces are vlan0, vlan1, vlan2, ...; and so on.

\*\* - The names of virtual interfaces are derived from the interfaces on which they are created. For example, virtual interfaces created on Ethernet interface wan1 are called wan1:1, wan1:2, and so on. Virtual interfaces created on VLAN interface vlan2 are called vlan2:1, vlan2:2, and so on. You cannot specify the number after the colon(:) in the web configurator; it is a sequential number. You can specify the number after the colon if you use the CLI to set up a virtual interface.

Table 47 Cellular and WLAN Interface Characteristics

CHARACTERISTICS	CELLULAR	
Name*	cellular <i>x</i>	
Configurable Zone	Yes**	
IP Address Assignment		
Static IP address	Yes	
DHCP client	Yes	
Routing metric	Yes	
Interface Parameters		
Bandwidth restrictions	Yes	
Packet size (MTU)	Yes	
Data size (MSS)	Yes	
DHCP		
DHCP server	No	
DHCP relay	No	
Connectivity Check	Yes	

\* - Each name consists of letters (interface type), followed by a number (*x*). For most interfaces, *x* is limited by the maximum number of the type of interface. For WLAN interfaces, the first number identifies the slot and the second number identifies the individual interface.

\*\* - Cellular interfaces can be added to the WAN zone or no zone.

## 16.1.2 Relationships Between Interfaces

In the Zyxel Device, interfaces are usually created on top of other interfaces. Only Ethernet interfaces are created directly on top of the physical ports (or port groups). The relationships between interfaces are explained in the following table.

Table 48 Relationships Between Different Types of Interfaces

INTERFACE	REQUIRED PORT / INTERFACE
<b>Ethernet interface</b>	physical port port group
<b>VLAN interface</b>	Ethernet interface
<b>bridge interface</b>	Ethernet interface* VLAN interface*
<b>PPPoE/PPTP interface</b> (For some Zyxel Device models)	Ethernet interface* VLAN interface* bridge interface
<b>PPPoE/PPTP interface</b> (For other Zyxel Device models)	WAN1, WAN2, OPT*
<b>virtual interface</b> (virtual Ethernet interface) (virtual VLAN interface) (virtual bridge interface)	Ethernet interface* VLAN interface* bridge interface
<b>trunk</b>	Ethernet interface Cellular interface VLAN interface bridge interface PPPoE/PPTP interface

\* - You cannot set up a PPPoE/PPTP interface, virtual Ethernet interface, or virtual VLAN interface if the underlying interface is a member of a bridge. You also cannot add an Ethernet interface or VLAN interface to a bridge if the member interface has a virtual interface or PPPoE/PPTP interface on top of it.

## 16.2 Interface General Commands Summary

The following table identifies the values required for many of these commands. Other input values are discussed with the corresponding commands.

Table 49 Input Values for General Interface Commands

LABEL	DESCRIPTION
<i>interface_name</i>	<p>The name of the interface.</p> <p>Ethernet interface: For some Zyxel Device models, use <i>gex</i>, <math>x = 1 - N</math>, where <math>N</math> equals the highest numbered Ethernet interface for your Zyxel Device model.</p> <p>For other Zyxel Device models use a name such as <i>wan1</i>, <i>wan2</i>, <i>opt</i>, <i>lan1</i>, <i>ext-wlan</i>, or <i>dmz</i>.</p> <p>virtual interface on top of Ethernet interface: add a colon (:) and the number of the virtual interface. For example: <i>gex:y</i>, <math>x = 1 - N</math>, <math>y = 1 - 4</math></p> <p>VLAN interface: <i>vlanx</i>, <math>x = 0 - 4094</math></p> <p>virtual interface on top of VLAN interface: <i>vlanx:y</i>, <math>x = 0 - 4094</math>, <math>y = 1 - 4</math></p> <p>bridge interface: <i>brx</i>, <math>x = 0 - N</math>, where <math>N</math> depends on the number of bridge interfaces your Zyxel Device model supports.</p> <p>virtual interface on top of bridge interface: <i>brx:y</i>, <math>x =</math> the number of the bridge interface, <math>y = 1 - 4</math></p> <p>PPPoE/PPTP interface: <i>pppx</i>, <math>x = 0 - N</math>, where <math>N</math> depends on the number of PPPoE/PPTP interfaces your Zyxel Device model supports.</p>
<i>profile_name</i>	The name of the DHCP . You may use 1-31 alphanumeric characters, underscores(_), or dashes (-), but the first character cannot be a number. This value is case-sensitive.
<i>domain_name</i>	Fully-qualified domain name. You may up to 254 alphanumeric characters, dashes (-), or periods (.), but the first character cannot be a period.

The following sections introduce commands that are supported by several types of interfaces. See [Section 16.6 on page 138](#) for the unique commands for each type of interface.

### 16.2.1 Basic Interface Properties and IP Address Commands

This table lists basic properties and IP address commands.

Table 50 *interface* General Commands: Basic Properties and IP Address Assignment

COMMAND	DESCRIPTION
<code>show interface {ethernet   vlan   bridge   ppp} status</code>	Displays the connection status of the specified type of interfaces.
<code>show interface {interface_name   ethernet   vlan   bridge   ppp   virtual ethernet   virtual vlan   virtual bridge   all}</code>	Displays information about the specified interface, specified type of interfaces, or all interfaces. See <a href="#">Section 16.6.1 on page 141</a> for all possible cellular status description.
<code>show ipv6 interface {interface_name   all}</code>	Displays information about the specified IPv6 interface or all IPv6 interfaces.
<code>show ipv6 static address interface</code>	Displays the static IPv6 addresses configured on the specified IPv6 interface.
<code>show ipv6 nd ra status config_interface</code>	Displays the specified IPv6 interface's IPv6 router advertisement configuration.

Table 50 interface General Commands: Basic Properties and IP Address Assignment (continued)

COMMAND	DESCRIPTION
<code>show interface send statistics interval</code>	Displays the interval for how often the Zyxel Device refreshes the sent packet statistics for the interfaces.
<code>show interface summary all</code>	Displays basic information about the interfaces.
<code>show interface summary all status</code>	Displays the connection status of the interfaces.
<code>[no] interface interface_name</code>	Creates the specified interface if necessary and enters sub-command mode. The <code>no</code> command deletes the specified interface.
<code>[no] description description</code>	Specifies the description for the specified interface. The <code>no</code> command clears the description.  <i>description:</i> You can use alphanumeric and ( ) + / : = ? ! * # @ \$ _ % - characters, and it can be up to 60 characters long.
<code>[no] downstream &lt;0..1048576&gt;</code>	This is reserved for future use.  Specifies the downstream bandwidth for the specified interface. The <code>no</code> command sets the downstream bandwidth to 1048576.
<code>exit</code>	Leaves the sub-command mode.
<code>[no] ip address dhcp</code>	Makes the specified interface a DHCP client; the DHCP server gives the specified interface its IP address, subnet mask, and gateway. The <code>no</code> command makes the IP address static IP address for the specified interface. (See the next command to set this IP address.)
<code>ip address dhcp option-60 &lt;text&gt;</code>	This command is available for external interfaces only. DHCP Option 60 is used by the Zyxel Device for identification to the DHCP server using the VCI (Vendor Class Identifier) on the DHCP server. The Zyxel Device adds it in the initial DHCP discovery message that a DHCP client broadcasts in search of an IP address. The DHCP server can assign different IP addresses or options to clients with the specific VCI or reject the request from clients without the specific VCI.  Type a string using up to 63 of these characters [a-zA-Z0-9!\*#\$%&\()*+,-./:;<=>?@\[\]\^_`{ } ] to identify this Zyxel Device to the DHCP server. For example, Zyxel-TW.
<code>[no] ip address ip subnet_mask</code>	Assigns the specified IP address and subnet mask to the specified interface. The <code>no</code> command clears the IP address and the subnet mask.
<code>[no] ip gateway ip</code>	Adds the specified gateway using the specified interface. The <code>no</code> command removes the gateway.
<code>ip gateway ip metric &lt;0..15&gt;</code>	Sets the priority (relative to every gateway on every interface) for the specified gateway. The lower the number, the higher the priority.
<code>[no] metric &lt;0..15&gt;</code>	Sets the tunnel, PPPoE/PPTP, or cellular interface's priority relative to other interfaces. The lower the number, the higher the priority.
<code>[no] mss &lt;536..1460&gt;</code>	Specifies the maximum segment size (MSS) the interface is to use. MSS is the largest amount of data, specified in bytes, that the interface can handle in a single, unfragmented piece. The <code>no</code> command has the interface use its default MSS.
<code>[no] mtu &lt;576..1500&gt;</code>	Specifies the Maximum Transmission Unit, which is the maximum number of bytes in each packet moving through this interface. The Zyxel Device divides larger packets into smaller fragments. The <code>no</code> command resets the MTU to 1500.

Table 50 interface General Commands: Basic Properties and IP Address Assignment (continued)

COMMAND	DESCRIPTION
[no] shutdown	Deactivates the specified interface. The no command activates it.
traffic-prioritize {tcp-ack content-filter dns ipsec-vpn ssl-vpn} bandwidth <0..1048576> priority <1..7> [maximize-bandwidth-usage];	Applies traffic priority when the interface sends TCP-ACK traffic, traffic for querying the content filter, traffic for resolving domain names, or encrypted traffic for an IPsec or SSL VPN tunnel. It also sets how much bandwidth the traffic can use and can turn on maximize bandwidth usage.
traffic-prioritize {tcp-ack content-filter dns ipsec-vpn ssl-vpn} deactivate	Turns off traffic priority settings for when the interface sends the specified type of traffic.
[no] upstream <0..1048576>	Specifies the upstream bandwidth for the specified interface. The no command sets the upstream bandwidth to 1048576.
interface <i>interface_name</i> ipv6	Creates the specified IPv6 interface if necessary and enters sub-command mode.
address <i>ipv6_addr_prefix</i>	Sets an IPv6 address with prefix for the interface.
gateway <i>ipv6_addr</i> metric <0..15>	Sets the specified IPv6 address's metric.
enable	Turns on the IPv6 interface.
nd ra accept	Sets the IPv6 interface to accept IPv6 neighbor discovery router advertisement messages.
nd ra advertise	Sets the IPv6 interface to send IPv6 neighbor discovery router advertisement messages.
nd ra managed-config-flag	Turns on the flag in IPv6 router advertisements that tells hosts to use managed (stateful) protocol for address autoconfiguration in addition to any addresses autoconfigured using stateless address autoconfiguration.
nd ra other-config-flag	Turns on the other stateful configuration flag in IPv6 router advertisements that tells hosts to use administered (stateful) protocol to obtain autoconfiguration information other than addresses.
nd ra mtu <1280..1500>   <0>	Sets the Maximum Transmission Unit (MTU) size of IPv6 packets sent on the interface.
nd ra hop-limit <0..255>	Sets the maximum number of hops for router advertisements and all IPv6 packets originating from the interface.
nd ra router-preference {low   medium   high }	Sets the Default Router Preference (DRP) extension metric (low, medium, or high) in the interface's IPv6 neighbor discovery router advertisement messages.
nd ra prefix-advertisement <i>ipv6_addr_prefix</i> [ auto { on   off} ] [ link{ on   off } ] [ preferred-time { <0..4294967294>   infinity } ] [ valid-time{ <0..4294967294>   infinity } ]	Sets the IPv6 prefix that the Zyxel Device advertises to its clients, whether or not to advertise it, and how long before the prefix's preference and lifetime expire.
nd ra min-rtr-interval <3..1350>	Sets the minimum IPv6 router advertisement transmission interval.
nd ra max-rtr-interval <4..1800>	Sets the maximum IPv6 router advertisement transmission interval.
nd ra reachable-time <0..3600000>	Sets the amount of time a remote IPv6 node is considered reachable after a reachability confirmation event.

Table 50 interface General Commands: Basic Properties and IP Address Assignment (continued)

COMMAND	DESCRIPTION
<code>nd ra default-lifetime &lt;4..9000&gt;</code>	Sets the router lifetime value is included in all IPv6 router advertisements sent out the interface. The router lifetime value should be equal to or greater than the router advertisement interval.
<code>nd ra retrans-timer &lt;0..4294967295&gt;</code>	Sets the IPv6 router advertisement retransmission interval in milliseconds.
<code>ipv6 address dhcp6_profile dhcp6_suffix_128</code>	Has the Zyxel Device obtain an IPv6 prefix from the ISP or a connected uplink router for an internal network, such as the LAN or DMZ.  <i>dhcp6_profile</i> : Specify the DHCPv6 request object to use.  <i>dhcp6_suffix_128</i> : Specify the ending part of the IPv6 address, a slash (/), and the prefix length. The Zyxel Device appends it to the delegated prefix.  For example, you got a delegated prefix of 2003:1234:5678/48. You want to configure an IP address of 2003:1234:5678:1111::1/128 for this interface, then enter ::1111:0:0:0:1/128 for the <i>dhcp6_suffix_128</i> .
<code>nd ra prefix-advertisement dhcp6_profile dhcp6_suffix_64</code>	Configures the network prefix to use a delegated prefix as the beginning part of the network prefix.  <i>dhcp6_profile</i> : Specify the DHCPv6 request object to use for generating the network prefix for the network.  <i>dhcp6_suffix_64</i> : Specify the ending part of the IPv6 network address plus a slash (/) and the prefix length. The Zyxel Device appends it to the selected delegated prefix. The combined address is the network prefix for the network.  For example, you got a delegated prefix of 2003:1234:5678/48. You want to divide it into 2003:1234:5678:1111/64 for this interface and 2003:1234:5678:2222/64 for another interface. You can use ::1111/64 and ::2222/64 for the suffix address respectively. But if you do not want to divide the delegated prefix into subnetworks, enter ::0/48 here, which keeps the same prefix length (/48) as the delegated prefix.
<code>dhcp6 { server   client   relay upper { config_interface   ipv6_addr } }</code>	Sets the IPv6 interface to be a DHCPv6 server, client or relay. For relay, specify an interface from which to get the DHCPv6 server's address or the IPv6 address of a DHCPv6 server.
<code>dhcp6 rapid-commit</code>	This shortens the DHCPv6 message exchange process from four to two steps to help reduce network traffic.  Note: Make sure you also enable this option in the DHCPv6 clients to make rapid commit work.
<code>dhcp6 address-request</code>	Get this interface's IPv6 address from the DHCPv6 server.
<code>dhcp6 refresh-time { &lt;600..4294967294&gt;   infinity }</code>	Sets the number of seconds a DHCPv6 client should wait before refreshing information retrieved from DHCPv6.
<code>dhcp6 duid { duid   mac }</code>	Specify the DHCP Unique IDentifier (DUID) of the interface or have it generated from the interface's default MAC address.
<code>dhcp6-lease-object dhcp6_profile</code>	For a DHCPv6 server interface, specify the profile of DHCPv6 lease settings to offer to DHCPv6 clients.
<code>dhcp6-request-object dhcp6_profile</code>	For a DHCPv6 client interface, specify the profile of DHCPv6 request settings that determine what additional information to get from the DHCPv6 server.

Table 50 interface General Commands: Basic Properties and IP Address Assignment (continued)

COMMAND	DESCRIPTION
<code>interface interface_name no ipv6</code>	Enters the sub-command mode for deleting the specified IPv6 address or removing its settings.
<code>enable</code>	Turns off the IPv6 interface.
<code>address ipv6_addr_prefix</code>	Removes the IPv6 interface's IPv6 prefix setting.
<code>gateway</code>	Removes the IPv6 interface's gateway setting.
<code>nd ra accept</code>	Sets the IPv6 interface to discard IPv6 neighbor discovery router advertisement messages.
<code>nd ra advertise</code>	Has the IPv6 interface not send IPv6 neighbor discovery router advertisement messages.
<code>nd ra managed-config-flag</code>	Turns off the flag in IPv6 router advertisements that tells hosts to use managed (stateful) protocol for address autoconfiguration in addition to any addresses autoconfigured using stateless address autoconfiguration.
<code>nd ra other-config-flag</code>	Turns off the other stateful configuration flag in IPv6 router advertisements that tells hosts to use administered (stateful) protocol to obtain autoconfiguration information other than addresses.
<code>nd ra mtu</code>	Removes the Maximum Transmission Unit (MTU) size setting for IPv6 packets the interface sends.
<code>nd ra hop-limit</code>	Removes the maximum number of hops setting for router advertisements and all IPv6 packets originating from the interface.
<code>nd ra min-rtr-interval</code>	Removes the minimum IPv6 router advertisement transmission interval setting.
<code>nd ra max-rtr-interval</code>	Removes the maximum IPv6 router advertisement transmission interval setting.
<code>nd ra reachable-time</code>	Sets the amount of time a remote IPv6 node is considered reachable after a reachability confirmation event to the default.
<code>nd ra default-lifetime</code>	Sets the router lifetime value included in all IPv6 router advertisements the interface sends to the default. The router lifetime value should be equal to or greater than the router advertisement interval.
<code>nd ra retrans-timer</code>	Sets the IPv6 router advertisement retransmission interval to the default.
<code>ipv6 address dhcp6_profile dhcp6_suffix_128</code>	Removes the specified setting for having the Zyxel Device obtain an IPv6 prefix from the ISP or a connected uplink router for an internal network.
<code>nd ra prefix-advertisement DHCP6_PROFILE DHCP6_SUFFIX_64</code>	Removes the specified setting for using a delegated prefix as the beginning part of the network prefix.
<code>dhcp6</code>	Sets the interface's DHCPv6 setting back to the default.
<code>dhcp6 address-request</code>	Has the Zyxel Device not get this interface's IPv6 address from the DHCPv6 server.
<code>dhcp6 rapid-commit</code>	Has the Zyxel Device use the full four-step DHCPv6 message exchange process.  Note: Make sure you also disable this option in the DHCPv6 clients.
<code>dhcp6-lease-object dhcp6_profile</code>	Removes the specified profile of DHCPv6 lease settings to offer to DHCPv6 clients.

Table 50 interface General Commands: Basic Properties and IP Address Assignment (continued)

COMMAND	DESCRIPTION
<code>dhcp6-request-object</code> <code>dhcp6_profile</code>	Removes the specified profile of DHCPv6 request settings that determine what additional information to get from the DHCPv6 server.
<code>interface reset</code> { <code>interface_name</code>   <code>virtual_interface_name</code>   <code>all</code> }	Resets the interface statistics TxPkts (transmitted packets) and RxPkts (received packets) counts to 0. You can use the <code>show interface summary all status</code> command to see the interface statistics.
<code>interface send statistics interval</code> <15..3600>	Sets how often the Zyxel Device sends interface statistics to external servers. For example, syslog server and Vantage Report server.
<code>show interface-name</code>	Displays all PPP and Ethernet interface system name and user-defined name mappings.
<code>interface-name</code> { <code>ppp_interface</code>   <code>ethernet_interface</code> } <code>user_defined_name</code>	Specifies a name for a PPP or an Ethernet interface. It can use alphanumeric characters, hyphens, and underscores, and it can be up to 11 characters long.  <code>ppp_interface</code>   <code>ethernet_interface</code> : This must be the system name of a PPP or an Ethernet interface. Use the <code>show interface-name</code> command to see the system name of interfaces.  <code>user_defined_name</code> : <ul style="list-style-type: none"> <li>This name cannot be one of the follows: "ethernet", "ppp", "vlan", "bridge", "virtual", "wlan", "cellular", "aux", "tunnel", "status", "summary", "all"</li> <li>This name cannot begin with one of the follows either: "ge", "ppp", "vlan", "wlan-", "br", "cellular", "aux", "tunnel".</li> </ul>
<code>interface-rename</code> <code>old_user_defined_name</code> <code>new_user_defined_name</code>	Modifies the user-defined name of a PPP or an Ethernet interface.

### 16.2.1.1 Basic Interface Properties Command Examples

The following commands make Ethernet interface ge1 a DHCP client.

```
Router# configure terminal
Router(config)# interface ge1
Router(config-if)# ip address dhcp
Router(config-if)# exit
```



This example shows how to modify the name of interface ge4 to "VIP". First you have to check the interface system name (ge4 in this example) on the Zyxel Device. Then change the name and display the result.

```
Router> show interface-name
No.  System Name      User Defined Name
=====
1    ge1                ge1
2    ge2                ge2
3    ge3                ge3
4    ge4                ge4
5    ge5                ge5
Router> configure terminal
Router(config)# interface-name ge4 VIP
Router(config)# show interface-name
No.  System Name      User Defined Name
=====
1    ge1                ge1
2    ge2                ge2
3    ge3                ge3
4    ge4                VIP
5    ge5                ge5
Router(config)#
```

This example shows how to change the user defined name from VIP to Partner. Note that you have to use the "interface-rename" command if you do not know the system name of the interface. To use the "interface-name" command, you have to find out the corresponding system name first (ge4 in this example). This example also shows how to change the user defined name from Partner to Customer using the "interface-name" command.

```
Router(config)# interface-rename VIP Partner
Router(config)# show interface-name
No.  System Name      User Defined Name
=====
1    ge1                ge1
2    ge2                ge2
3    ge3                ge3
4    ge4                Partner
5    ge5                ge5
Router(config)#
Router(config)# interface-name ge4 Customer
Router(config)# show interface-name
No.  System Name      User Defined Name
=====
1    ge1                ge1
2    ge2                ge2
3    ge3                ge3
4    ge4                Customer
5    ge5                ge5
```

This example shows how to restart an interface. You can check all interface names on the Zyxel Device. Then use either the system name or user-defined name of an interface (ge4 or Customer in this example) to restart it.

```
Router> show interface-name
No.  System Name      User Defined Name
=====
1    ge1                ge1
2    ge2                ge2
3    ge3                ge3
4    ge4                Customer
5    ge5                ge5
Router> configure terminal
Router(config)# interface reset ge4
Router(config)# interface reset Customer
Router(config)#
```

## 16.2.2 IGMP Proxy Commands

Internet Group Management Protocol (IGMP) proxy is used for multicast routing. IGMP proxy enables the Zyxel Device to issue IGMP host messages on behalf of hosts that the Zyxel Device discovered on its IGMP-enabled interfaces. The Zyxel Device acts as a proxy for its hosts.

Enter configuration terminal mode and select an interface

Table 51 interface Commands: IGMP Proxy Commands

COMMAND	DESCRIPTION
[no]igmp activate	Enables IGMP proxy on this interface. The no command disables IGMP proxy on this interface.
igmp direction	Sets the direction for IGMP proxy on this interface. <ul style="list-style-type: none"> <li>downstream - enable on the interface which connects to the multicast hosts.</li> <li>upstream - enable on the interface which connects to a router running IGMP that is closer to the multicast server</li> </ul>
igmp version <1..3>	Sets the IGMP version to be used on this Zyxel Device interface.

### 16.2.2.1 IGMP Command Example

The following commands activate IGMP version 2 upstream on the lan1 interface.

```
Router> enable
Router#
Router# configure terminal
Router(config)# interface lan1
Router(config-if-lan1)# igmp
activate
direction
version
Router(config-if-lan1)# igmp activate
Router(config-if-lan1)# igmp direction
downstream
upstream
Router(config-if-lan1)# igmp direction upstream
Router(config-if-lan1)# igmp version
<1..3>
Router(config-if-lan1)# igmp version 2
Router(config-if-lan1)#
Router(config-if-lan1)# exit
```

### 16.2.3 Proxy ARP Commands

Enable Proxy ARP (RFC 1027) to allow the Zyxel Device to answer external interface ARP requests on behalf of a device on its internal interface. Interfaces supported are:

- Ethernet
- VLAN
- Bridge

Enter configuration terminal mode and select an interface

Table 52 interface Commands: Proxy ARP Commands

COMMAND	DESCRIPTION
[no] ip proxy-arp activate	Enables proxy ARP on this interface. The <b>no</b> command disables proxy ARP on this interface.
[no] ip proxy-arp { <i>ipv4</i>   <i>ipv4_range</i>   <i>ipv4_cidr</i> }	Sets the proxy ARP target IP address, IP address range or IP address subnet on this interface.  <i>ipv4</i> : IPv4 address <W.X.Y.Z>  <i>ipv4_range</i> : Range of IPv4 addresses <W.X.Y.Z>-<W.X.Y.Z>  <i>ipv4_cidr</i> : IPv4 subnet in CIDR format, i.e. 192.168.1.0/32 <W.X.Y.Z>/<1..32>  The Zyxel Device answers external ARP requests only if they match one of these inputted target IP addresses. For example, if <i>ipv4</i> is 192.168.1.5, then the Zyxel Device will answer ARP requests coming from the WAN only if it contains 192.168.1.5 as the target IP address.  The <b>no</b> command disables the proxy ARP target IP address, IP address range or IP address subnet on this interface.

Table 52 interface Commands: Proxy ARP Commands (continued)

COMMAND	DESCRIPTION
<code>show interface interface_name proxy-arp address</code>	Displays the proxy ARP target IP address, IP address range or IP address subnet on the named interface.
<code>show interface interface_name proxy-arp status</code>	Displays if proxy ARP is enabled on the named interface.

### 16.2.3.1 Proxy ARP Command Example

The following commands activate proxy ARP on the lan1 interface.

```
Router(config)# interface lan1
Router(config-if-lan1)# ip proxy-arp activate
Router(config-if-lan1)# ip proxy-arp 192.168.1.5
Router(config-if-lan1)# exit
Router(config)# show interface lan1 proxy-arp status
Proxy ARP status: yes
Router(config)# show interface lan1 proxy-arp address
No. IP Address
=====
1 192.168.1.5
Router(config)#
```

### 16.2.4 DHCP Setting Commands

This table lists DHCP setting commands. DHCP is based on DHCP pools. Create a DHCP pool if you want to assign a static IP address to a MAC address or if you want to specify the starting IP address and pool size of a range of IP addresses that can be assigned to DHCP clients. There are different commands for each configuration. Afterwards, in either case, you have to bind the DHCP pool to the interface.

Table 53 interface Commands: DHCP Settings

COMMAND	DESCRIPTION
<code>show ip dhcp list interface {all   interface name} keyword keyword</code>	Shows the interfaces and their static and DHCP-assigned IP addresses.  <i>all</i> : Uses this to list all interfaces and their static and DHCP-assigned IP addresses.  <i>interface name</i> : Uses this to show the specified interface and to which devices it has assigned static and DHCP IP addresses.  <i>keyword</i> : You can use up to 63 alphanumeric and ()+/:=?!*#@\$_%- characters. This searches the interfaces and their information, such as IP addresses, MAC addresses and so on.
<code>show ip dhcp static interface {all   interface name}</code>	Shows the interfaces and their static IP addresses.  <i>all</i> : Uses this to list all interfaces and their static IP addresses.  <i>interface name</i> : Uses this to show the specified interface and to which devices it has assigned static IP addresses.
<code>show ip dhcp dhcp-options</code>	Shows the DHCP extended option settings.
<code>show ip dhcp pool [profile_name]</code>	Shows information about the specified DHCP pool or about all DHCP pools.

Table 53 interface Commands: DHCP Settings (continued)

COMMAND	DESCRIPTION
<code>show ip dhcp pool</code> <code>profile_name dhcp-options</code>	Shows the specified DHCP pool's DHCP extended option settings.
<code>ip dhcp pool rename</code> <code>profile_name profile_name</code>	Renames the specified DHCP pool from the first <code>profile_name</code> to the second <code>profile_name</code> .
<code>ip dhcp static</code> <code>_import_static_file import</code> <code>file name interface</code> <code>interface name</code>	Imports a csv file to the specified interface on the Zyxel Device. The IP/MAC binding settings and description to identify these settings in the file will be applied to the Zyxel Device.  Configure your csv file in the order of IP address, MAC address and description. Spaces are allowed. Separate each item with a comma, for example, 1.1.1.1,22:22:33:44:55:02,test. Press enter to configure the next group in a new line.  Your currently configured IP/MAC binding settings and entries description will be overwritten once you import the file.
<code>[no] ip dhcp pool</code> <code>profile_name</code>	Creates a DHCP pool if necessary and enters sub-command mode. You can use the DHCP pool to create a static entry or to set up a range of IP addresses to assign dynamically.  About the sub-command settings: <ul style="list-style-type: none"> <li>• If you use the <code>host</code> command, the Zyxel Device treats this DHCP pool as a static DHCP entry.</li> <li>• If you do not use the <code>host</code> command and use the <code>network</code> command, the Zyxel Device treats this DHCP pool as a pool of IP addresses.</li> <li>• If you do not use the <code>host</code> command or the <code>network</code> command, the DHCP pool is not properly configured and cannot be bound to any interface.</li> </ul> The <code>no</code> command removes the specified DHCP pool.
<code>show</code>	Shows information about the specified DHCP pool.
	Use the following commands to create a static DHCP entry. If you do not use the <code>host</code> command, the commands that are not in this section have no effect, but you can still set them.
<code>[no] host ip</code>	Specifies the static IP address the Zyxel Device should assign. Use this command, along with <code>hardware-address</code> , to create a static DHCP entry.  Note: The IP address must be in the same subnet as the interface to which you plan to bind the DHCP pool.  When this command is used, the Zyxel Device treats this DHCP pool like a static entry, regardless of the <code>network</code> setting. The <code>no</code> command clears this field.
<code>[no] hardware-address</code> <code>mac_address</code>	Reserves the DHCP pool for the specified MAC address. Use this command, along with <code>host</code> , to create a static DHCP entry. The <code>no</code> command clears this field.
<code>[no] client-identifier</code> <code>mac_address</code>	Specifies the MAC address that appears in the DHCP client list. The <code>no</code> command clears this field.
<code>[no] client-name</code> <code>host_name</code>	Specifies the host name that appears in the DHCP client list. The <code>no</code> command clears this field.  <code>host_name</code> : You may use 1-31 alphanumeric characters, underscores( <code>_</code> ), or dashes( <code>-</code> ), but the first character cannot be a number. This value is case-sensitive.

Table 53 interface Commands: DHCP Settings (continued)

COMMAND	DESCRIPTION
	Use the following commands to create a pool of IP addresses. These commands have no effect if you use the <code>host</code> command. You can still set them, however.
<pre>dhcp-option &lt;1..254&gt; option_name {boolean &lt;0..1&gt;  uint8 &lt;0..255&gt;   uint16 &lt;0..65535&gt;   uint32 &lt;0..4294967295&gt;   ip ipv4 [ipv4 [ipv4]]   fqdn fqdn [fqdn [fqdn]]   text text   hex hex   vivc enterprise_id hex_s [enterprise_id hex_s]   vivs enterprise_id hex_s [enterprise_id hex_s]}</pre>	<p>Adds or edits a DHCP extended option for the specified DHCP pool.</p> <p><i>text</i>: String of up to 250 characters</p> <p><i>hex</i>: String of up to 250 hexadecimal pairs.</p> <p><i>vivc</i>: Vendor-Identifying Vendor Class option. A DHCP client may use this option to unambiguously identify the vendor that manufactured the hardware on which the client is running, the software in use, or an industry consortium to which the vendor belongs.</p> <p><i>enterprise_id</i>: Number &lt;0..4294967295&gt;.</p> <p><i>hex_s</i>: String of up to 120 hexadecimal pairs.</p> <p><i>vivs</i>: Vendor-Identifying Vendor-Specific option. DHCP clients and servers may use this option to exchange vendor-specific information.</p>
<pre>no dhcp-option &lt;1..254&gt;</pre>	Removes the DHCP extended option for the specified DHCP pool.
<pre>network IP/&lt;1..32&gt; network ip mask no network</pre>	<p>Specifies the IP address and subnet mask of the specified DHCP pool. The subnet mask can be written in w.x.y.z format or in /&lt;1..32&gt; format.</p> <p>Note: The DHCP pool must have the same subnet as the interface to which you plan to bind it.</p> <p>The <code>no</code> command clears these fields.</p>
<pre>[no] default-router ip</pre>	Specifies the default gateway DHCP clients should use. The <code>no</code> command clears this field.
<pre>[no] description description</pre>	Specifies a description for the DHCP pool for identification. The <code>no</code> command removes the description.
<pre>[no] domain-name domain_name</pre>	Specifies the domain name assigned to DHCP clients. The <code>no</code> command clears this field.
<pre>[no] starting-address ip -size &lt;1..65535&gt;</pre>	<p>Sets the IP start address and maximum pool size of the specified DHCP pool. The final pool size is limited by the subnet mask.</p> <p>Note: You must specify the <code>network</code> number first, and the start address must be in the same subnet.</p> <p>The <code>no</code> command clears the IP start address and maximum pool size.</p>
<pre>[no] first-dns-server {ip   interface_name {1st-dns   2nd-dns   3rd-dns}   ZyWALL}</pre>	Sets the first DNS server to the specified IP address, the specified interface's first, second, or third DNS server, or the Zyxel Device itself. The <code>no</code> command resets the setting to its default value.
<pre>[no] second-dns-server {ip   interface_name {1st-dns   2nd-dns   3rd-dns}   ZyWALL}</pre>	Sets the second DNS server to the specified IP address, the specified interface's first, second, or third DNS server, or the Zyxel Device itself. The <code>no</code> command resets the setting to its default value.
<pre>[no] third-dns-server {ip   interface_name {1st-dns   2nd-dns   3rd-dns}   ZyWALL}</pre>	Sets the third DNS server to the specified IP address, the specified interface's first, second, or third DNS server, or the Zyxel Device itself. The <code>no</code> command resets the setting to its default value.

Table 53 interface Commands: DHCP Settings (continued)

COMMAND	DESCRIPTION
[no] first-wins-server <i>ip</i>	Specifies the first WINS server IP address to assign to the remote users. The <code>no</code> command removes the setting.
[no] second-wins-server <i>ip</i>	Specifies the second WINS server IP address to assign to the remote users. The <code>no</code> command removes the setting.
[no] lease {<0..365> [<0..23> [<0..59>]]   infinite}	Sets the lease time to the specified number of days, hours, and minutes or makes the lease time infinite. The <code>no</code> command resets the first DNS server setting to its default value.
(no) bootp-server < <i>w.x.y.z</i> >	Sets the PXE (Preboot eXecution Environment) server public IPv4 address. PXE is available for computers on internal interfaces to allow them to boot up using boot software on a PXE server. The Zyxel Device acts as an intermediary between the PXE server and the computers that need boot software.  You must enable DHCP Server on the Zyxel Device so that it can receive information from the PXE server.
(no) bootfile-name < <i>filename</i> >	Sets the file name and extension of the boot loader software file (a computer program that loads the operating system for the computer) that is on the PXE server. If the wrong filename is typed, then the client computers cannot boot.
interface <i>interface_name</i>	Enters sub-command mode.
[no] ip dhcp-pool <i>profile_name</i>	Binds the specified interface to the specified DHCP pool. You have to remove any DHCP relays first. The <code>no</code> command removes the binding.
[no] ip helper-address <i>ip</i>	Creates the specified DHCP relay. You have to remove the DHCP pool first, if the DHCP pool is bound to the specified interface. The <code>no</code> command removes the specified DHCP relay.
release dhcp <i>interface-name</i>	Releases the TCP/IP configuration of the specified interface. The interface must be a DHCP client. This command is available in privilege mode, not configuration mode.
renew dhcp <i>interface-name</i>	Renews the TCP/IP configuration of the specified interface. The interface must be a DHCP client. This command is available in privilege mode, not configuration mode.
show ip dhcp binding [ <i>ip</i> ]	Displays information about DHCP bindings for the specified IP address or for all IP addresses.
clear ip dhcp binding { <i>ip</i>   *}	Removes the DHCP bindings for the specified IP address or for all IP addresses.

### 16.2.4.1 DHCP Setting Command Examples

The following example uses these commands to configure DHCP DHCP\_TEST.

```
Router# configure terminal
Router(config)# ip dhcp DHCP_TEST
Router(config-ip-dhcp)# network 192.168.1.0 /24
Router(config-ip-dhcp)# domain-name zyxel.com
Router(config-ip-dhcp)# first-dns-server 10.1.5.1
Router(config-ip-dhcp)# second-dns-server gel 1st-dns
Router(config-ip-dhcp)# third-dns-server 10.1.5.2
Router(config-ip-dhcp)# default-router 192.168.1.1
Router(config-ip-dhcp)# lease 0 1 30
Router(config-ip-dhcp)# starting-address 192.168.1.10 -size 30
Router(config-ip-dhcp)# hardware-address 00:0F:20:74:B8:18
Router(config-ip-dhcp)# client-identifier 00:0F:20:74:B8:18
Router(config-ip-dhcp)# client-name TWtester1
Router(config-ip-dhcp)# exit
Router(config)# interface gel
Router(config-if)# ip dhcp- DHCP_TEST
Router(config-if)# exit
Router(config)# show ip dhcp server status
binding interface : gel
  binding          : DHCP_TEST
```

### 16.2.4.2 DHCP Extended Option Setting Command Example

The following example configures the DHCP\_TEST with a SIP server (code 120) extended DHCP option with one IP address to provide to the SIP clients.

```
Router# configure terminal
Router(config)# ip dhcp DHCP_TEST
Router(config-ip-dhcp)# dhcp-option 120 sip ip 192.168.1.20
Router(config-ip-dhcp)# exit
```

### 16.2.4.3 CSV File Example

The following example shows how to configure a csv file.

```
1.1.1.1,22:22:33:44:55:02,test1
2.2.2.2,2C:54:91:88:C9:E3,test2
3.3.3.3,00:1B:44:11:3A:87,test3
```



## 16.2.5 Interface Parameter Command Examples

This table shows an example of each interface type's sub-commands. The sub-commands vary for different interface types.

Table 54 Examples for Different Interface Parameters

ETHERNET	VIRTUAL INTERFACE	PPPOE/PPTP
Router(config)# interface wan1 Router(config-if-wan1)# description downstream exit igmp intra-link ip ipv6 mac mss mtu no ping-check shutdown traffic-prioritize type upstream use-defined-mac	Router(config)# interface wan1:1 Router(config-if-vir)# description downstream exit ip no shutdown upstream	Router(config)# interface wan1_ppp Router(config-if-ppp)# account bind connectivity description downstream exit holdoff ipv6 local-address metric mss mtu no ping-check remote-address shutdown traffic-prioritize upstream
CELLULAR	VLAN	BRIDGE
Router(config)# interface cellular1 Router(config-if-cellular)# account band budget connectivity description device downstream encrypted-pin exit local-address metric mtu network-selection no pin ping-check remote-address shutdown traffic-prioritize upstream	Router(config)# interface vlan1 Router(config-if-vlan)# description downstream exit igmp intra-link ip ipv6 mac mss mtu no ping-check port priority-code shutdown traffic-prioritize type upstream use-defined-mac vlan-id	Router(config)# interface br0 Router(config-if-brg)# description downstream exit igmp intra-link ip ipv6 join mss mtu no ping-check shutdown traffic-prioritize type upstream

Table 54 Examples for Different Interface Parameters (continued)

TUNNEL	VTI	LAG
downstream exit ip ipv6 metric mtu no ping-check shutdown traffic-prioritize tunnel upstream	downstream exit ip metric no ping-check shutdown traffic-prioritize upstream	arp-interval arp-ip-target description downdelay downstream exit igmp intra-link ip ipv6 lacp-rate link-monitoring miimon mode mss mtu no ping-check primary shutdown slave traffic-prioritize type updelay upstream xmit-hash-policy

## 16.2.6 RIP Commands

This table lists the commands for RIP settings.

Table 55 interface Commands: RIP Settings

COMMAND	DESCRIPTION
<code>router rip</code>	Enters sub-command mode.
<code>[no] network interface_name</code>	Enables RIP for the specified interface. The <code>no</code> command disables RIP for the specified interface.
<code>[no] passive-interface interface_name</code>	Sets the RIP direction of the specified interface to in-only. The <code>no</code> command makes RIP bi-directional in the specified interface.
<code>[no] outonly-interface interface_name</code>	Sets the RIP direction of the specified interface to out-only. The <code>no</code> command makes RIP bi-directional in the specified interface.
<code>interface interface_name</code>	Enters sub-command mode.
<code>[no] ip rip {send   receive} version &lt;1..2&gt;</code>	Sets the send or receive version to the specified version number. The <code>no</code> command sets the send or received version to the current global setting for RIP. See <a href="#">Chapter 19 on page 172</a> for more information about routing protocols.
<code>[no] ip rip v2-broadcast</code>	Enables RIP-2 packets using subnet broadcasting. The <code>no</code> command uses multi-casting.
<code>show rip {global   interface {all   interface_name}}</code>	Displays RIP settings.

## 16.2.7 OSPF Commands

This table lists the commands for OSPF settings.

Table 56 interface Commands: OSPF Settings

COMMAND	DESCRIPTION
<code>router ospf</code>	Enters sub-command mode.
<code>[no] network <i>interface_name</i> area <i>ip</i></code>	Makes the specified interface part of the specified area. The <code>no</code> command removes the specified interface from the specified area, disabling OSPF in this interface.
<code>[no] passive-interface <i>interface_name</i></code>	Sets the OSPF direction of the specified interface to in-only. The <code>no</code> command makes OSPF bi-directional in the specified interface.
<code>interface <i>interface_name</i></code>	Enters sub-command mode.
<code>[no] ip ospf priority &lt;0..255&gt;</code>	Sets the priority of the specified interface to the specified value. The <code>no</code> command sets the priority to 1.
<code>[no] ip ospf cost &lt;1..65535&gt;</code>	Sets the cost to route packets through the specified interface. The <code>no</code> command sets the cost to 10.
<code>no ip ospf authentication</code>	Disables authentication for OSPF in the specified interface.
<code>ip ospf authentication</code>	Enables text authentication for OSPF in the specified interface.
<code>ip ospf authentication message-digest</code>	Enables MD5 authentication for OSPF in the specified interface.
<code>ip ospf authentication same-as-area</code>	To exchange OSPF routing information with peer border routers, you must use the same authentication method that they use. This command makes OSPF authentication in the specified interface follow the settings in the corresponding area.
<code>[no] ip ospf authentication-key <i>password</i></code>	Sets the simple text password for OSPF text authentication in the specified interface. The <code>no</code> command clears the text password.  <i>password</i> : 1-8 alphanumeric characters or underscores
<code>ip ospf message-digest-key &lt;1..255&gt; md5 <i>password</i></code>	Sets the ID and password for OSPF MD5 authentication in the specified interface.  <i>password</i> : 1-16 alphanumeric characters or underscores
<code>no ip ospf message-digest-key</code>	Clears the ID and password for OSPF MD5 authentication in the specified interface.
<code>[no] ip ospf hello-interval &lt;1..65535&gt;</code>	Sets the number of seconds between "hello" messages to peer routers. These messages let peer routers know the Zyxel Device is available. The <code>no</code> command sets the number of seconds to 10. See <code>ip ospf dead-interval</code> for more information.
<code>[no] ip ospf dead-interval &lt;1..65535&gt;</code>	Sets the number of seconds the Zyxel Device waits for "hello" messages from peer routers before it assumes the peer router is not available and deletes associated routing information. The <code>no</code> command sets the number of seconds to 40. See <code>ip ospf hello-interval</code> for more information.
<code>[no] ip ospf retransmit-interval &lt;1..65535&gt;</code>	Sets the number of seconds the Zyxel Device waits for an acknowledgment in response to a link state advertisement before it re-sends the advertisement.  Link state advertisements (LSA) are used to share the link state and routing information between routers.

## 16.2.8 Connectivity Check (Ping-check) Commands

Use these commands to have an interface regularly check the connection to the gateway you specified to make sure it is still available. You specify how often the interface checks the connection, how long to wait for a response before the attempt is a failure, and how many consecutive failures are required before the Zyxel Device stops routing to the gateway. The Zyxel Device resumes routing to the gateway the first time the gateway passes the connectivity check.

This table lists the ping-check commands

Table 57 interface Commands: Ping Check

COMMAND	DESCRIPTION
<code>show ping-check [interface_name   status]</code>	Displays information about ping check settings for the specified interface or for all interfaces.  <i>status</i> : displays the current connectivity check status for any interfaces upon which it is activated.
<code>[no] connectivity-check continuous-log activate</code>	Use this command to have the Zyxel Device log connectivity check result continuously. The <code>no</code> command disables the setting.
<code>show connectivity-check continuous-log status</code>	Displays the continuous log setting about connectivity check.
<code>interface interface_name</code>	Enters sub-command mode.
<code>[no] ping-check activate</code>	Enables ping check for the specified interface. The <code>no</code> command disables ping check for the specified interface.
<code>ping-check {FQDN   IPv4   default-gateway} [period &lt;5..3600&gt;] [timeout &lt;1..10&gt;] [fail-tolerance &lt;1..10&gt;] [method {icmp   tcp}] [port &lt;1..65535&gt;] [probe-condition {any   all}]</code>	Specifies what the Zyxel Device pings for the ping check; you can specify a fully-qualified domain name, IP address, or the default gateway for the interface.  <i>period</i> : number of seconds between each ping check.  <i>timeout</i> : number of seconds the Zyxel Device waits for a response.  <i>fail-tolerance</i> : number of times the Zyxel Device times out before it stops routing through the specified interface.  <i>method</i> : how the Zyxel Device checks the connection to the gateway. <code>icmp</code> pings the gateway you specify to make sure it is still available, while <code>tcp</code> performs a TCP handshake with the gateway you specify to make sure it is still available.  <i>port</i> : the port number to use for a TCP connectivity check.  <i>probe-condition</i> : If you ping two IP addresses or domain names, determines whether the ping fails only if both addresses do not respond ( <code>any</code> ) or if at least one does not respond ( <code>all</code> ).

### 16.2.8.1 Connectivity Check Command Example

The following commands show you how to set the WAN1 interface to use a TCP handshake on port 8080 to check the connection to IP address 1.1.1.2

```
Router# configure terminal
Router(config)# interface wan1
Router(config-if-wan1)# ping-check 1.1.1.2 method tcp port 8080
Router(config-if-wan1)# exit
Router(config)# show ping-check
Interface: wan1
Check Method: tcp
IP Address: 1.1.1.2
Period: 30
Timeout: 5
Fail Tolerance: 5
Activate: yes
Port: 8080
Router(config)#
```

## 16.3 Ethernet Interface Specific Commands

This section covers commands that are specific to Ethernet interfaces.

The following table identifies the values required for many of these commands. Other input values are discussed with the corresponding commands.

Table 58 Input Values for Ethernet Interface Commands

LABEL	DESCRIPTION
<i>interface_name</i>	The name of the Ethernet interface. This depends on the Zyxel Device model.  For some Zyxel Device models, use <i>gex</i> , <i>x</i> = 1-N, where N equals the highest numbered Ethernet interface for your Zyxel Device model.  For other Zyxel Device models use a name such as wan1, wan2, opt, lan1, ext-wlan, or dmz.

### 16.3.1 MAC Address Setting Commands

This table lists the commands you can use to set the MAC address of an interface. On some Zyxel Device models, these commands only apply to a WAN or OPT interface.

Table 59 *interface* Commands: MAC Setting

COMMAND	DESCRIPTION
<i>interface</i> <i>interface_name</i>	Enters sub-command mode.
no mac	Has the interface use its default MAC address.
mac <i>mac</i>	Specifies the MAC address the interface is to use.

Table 59 interface Commands: MAC Setting (continued)

COMMAND	DESCRIPTION
<pre>type {internal   external   general}</pre>	<p>Sets which type of network you will connect this interface. The Zyxel Device automatically adds default route and SNAT settings for traffic it routes from internal interfaces to external interfaces; for example LAN to WAN traffic.</p> <p><b>internal:</b> Set this to connect to a local network. Other corresponding configuration options: DHCP server and DHCP relay. The Zyxel Device automatically adds default SNAT settings for traffic flowing from this interface to an external interface.</p> <p><b>external:</b> Set this to connect to an external network (like the Internet). The Zyxel Device automatically adds this interface to the default WAN trunk.</p> <p><b>general:</b> Set this if you want to manually configure a policy route to add routing and SNAT settings for the interface.</p>
<pre>no use-defined- mac</pre>	Has the interface use its default MAC address.
<pre>use-defined-mac</pre>	Has the interface use a MAC address that you specify.

### 16.3.2 Port Grouping Commands

This section covers commands that are specific to port grouping.

Note: In CLI, representative interfaces are also called representative ports.

Table 60 Basic Interface Setting Commands

COMMAND	DESCRIPTION
<pre>show port-grouping</pre>	Displays which physical ports are assigned to each representative interface.
<pre>port status Port&lt;1..x&gt;</pre>	Enters a sub-command mode to configure the specified port's settings.
<pre>[no] duplex &lt;full   half&gt;</pre>	Sets the port's duplex mode. The no command returns the default setting.
<pre>exit</pre>	Leaves the sub-command mode.
<pre>[no] negotiation auto</pre>	Sets the port to use auto-negotiation to determine the port speed and duplex. The no command turns off auto-negotiation.
<pre>[no] speed &lt;100,10&gt;</pre>	Sets the Ethernet port's connection speed in Mbps. The no command returns the default setting.
<pre>show port setting</pre>	Displays the Ethernet port negotiation, duplex, and speed settings.
<pre>show port type physical</pre>	Displays the cable type that is used on the port.
<pre>show port status</pre>	Displays statistics for the Ethernet ports.
<pre>show port statistic portx interval &lt;5..3600&gt;</pre>	Displays the specified port's statistics and updates them according to the interval you set.

### 16.3.2.1 Port Grouping Command Examples

The following commands add physical port 7 to representative interface lan2.

```
Router# configure terminal
Router(config)# show port-grouping
No. Representative Name  Port1 Port2 Port3 Port4 Port5 Port6 Port7
=====
1  wan1                  yes   no   no   no   no   no   no
2  wan2                  no    yes  no   no   no   no   no
3  opt                   no    no   yes  no   no   no   no
4  lan1                  no    no   no   yes  yes  yes  no
5  lan2                  no    no   no   no   no   no   no
6  reserved              no    no   no   no   no   no   no
7  dmz                   no    no   no   no   no   no   yes
Router(config)#
Router(config)# port-grouping lan2
Router(config-port-grouping)# port 7
Router(config-port-grouping)# exit
Router(config)# show port-grouping
No. Representative Name  Port1 Port2 Port3 Port4 Port5 Port6 Port7
=====
1  wan1                  yes   no   no   no   no   no   no
2  wan2                  no    yes  no   no   no   no   no
3  opt                   no    no   yes  no   no   no   no
4  lan1                  no    no   no   yes  yes  yes  no
5  lan2                  no    no   no   no   no   no   yes
6  reserved              no    no   no   no   no   no   no
7  dmz                   no    no   no   no   no   no   no
Router(config)#
```

The following commands set port 1 to use auto-negotiation auto and port 2 to use a 10 Mbps connection speed and half duplex.

```
Router(config)# port status Port1
Router(config-port-status)# negotiation auto
Router(config-port-status)# exit
Router(config)# port status Port2
Router(config-port-status)# duplex half
Router(config-port-status)# speed 10
Router(config-port-status)# exit
Router(config)# exit
```

## 16.4 Virtual Interface Specific Commands

Virtual interfaces use many of the general interface commands discussed at the beginning of [Section 16.2 on page 115](#). There are no additional commands for virtual interfaces.

## 16.4.1 Virtual Interface Command Examples

The following commands set up a virtual interface on top of Ethernet interface ge1. The virtual interface is named ge1:1 with the following parameters: IP 1.2.3.4, subnet 255.255.255.0, gateway 4.6.7.8, upstream bandwidth 345, downstream bandwidth 123, and description "I am vir interface".

```
Router# configure terminal
Router(config)# interface ge1:1
Router(config-if-vir)# ip address 1.2.3.4 255.255.255.0
Router(config-if-vir)# ip gateway 4.6.7.8
Router(config-if-vir)# upstream 345
Router(config-if-vir)# downstream 123
Router(config-if-vir)# description I am vir interface
Router(config-if-vir)# exit
```

## 16.5 PPPoE/PPTP Specific Commands

This section covers commands that are specific to PPPoE/PPTP interfaces. PPPoE/PPTP interfaces also use many of the general interface commands discussed at the beginning of [Section 16.2 on page 115](#).

The following table identifies the values required for many of these commands. Other input values are discussed with the corresponding commands.

Table 61 Input Values for PPPoE/PPTP Interface Commands

LABEL	DESCRIPTION
<i>interface_name</i>	PPPoE/PPTP interface: pppx, x = 0 - N, where N depends on the number of PPPoE/PPTP interfaces your Zyxel Device model supports.
<i>profile_name</i>	The name of the ISP account. You may use 1-31 alphanumeric characters, underscores(_), or dashes (-), but the first character cannot be a number. This value is case-sensitive.

This table lists the PPPoE/PPTP interface commands.

Table 62 interface Commands: PPPoE/PPTP Interfaces

COMMAND	DESCRIPTION
<code>interface dial <i>interface_name</i></code>	Connects the specified PPPoE/PPTP interface.
<code>interface disconnect <i>interface_name</i></code>	Disconnects the specified PPPoE/PPTP interface.
<code>interface <i>interface_name</i></code>	Creates the specified interface if necessary and enters sub-command mode.
<code>[no] account <i>profile_name</i></code>	Specifies the ISP account for the specified PPPoE/PPTP interface. The <code>no</code> command clears the ISP account field.
<code>[no] bind <i>interface_name</i></code>	Specifies the base interface for the PPPoE/PPTP interface. The <code>no</code> command removes the base interface.
<code>[no] connectivity {nail-up   dial-on-demand}</code>	Specifies whether the specified PPPoE/PPTP interface is always connected (nail-up) or connected only when used (dial-on-demand). The <code>no</code> command sets it to dial-on-demand.
<code>[no] local-address <i>ip</i></code>	Specifies a static IP address for the specified PPPoE/PPTP interface. The <code>no</code> command makes the PPPoE/PPTP interface a DHCP client; the other computer assigns the IP address.



Table 62 interface Commands: PPPoE/PPTP Interfaces (continued)

COMMAND	DESCRIPTION
[no] remote-address <i>ip</i>	Specifies the IP address of the PPPoE/PPTP server. If the PPPoE/PPTP server is not available at this IP address, no connection is made. The <code>no</code> command lets the Zyxel Device get the IP address of the PPPoE/PPTP server automatically when it establishes the connection.
[no] mss <536..1452>	Specifies the maximum segment size (MSS) the interface can use. MSS is the largest amount of data, specified in bytes, that the interface can handle in a single, unfragmented piece. The <code>no</code> command has the Zyxel Device use its default MSS setting.
mtu <576..1492>	Sets the Maximum Transmission Unit in bytes.
[no] ipv6 enable	Turns on the IPv6 interface. The <code>no</code> command turns it off.
[no] ipv6 nd ra accept	Sets the IPv6 interface to accept IPv6 neighbor discovery router advertisement messages. The <code>no</code> command sets the IPv6 interface to discard IPv6 neighbor discovery router advertisement messages.
[no] ipv6 metric <0..15>	Sets the interface's metric for IPv6 traffic. The <code>no</code> command clears it.
[no] ipv6 address <i>dhcp6_profile</i> <i>dhcp6_suffix_128</i>	Has the Zyxel Device obtain an IPv6 prefix from the ISP or a connected uplink router for an internal network, such as the LAN or DMZ. The <code>no</code> command removes the specified setting for using a delegated prefix as the beginning part of the network prefix.  <i>dhcp6_profile</i> : Specify the DHCPv6 request object to use.  <i>dhcp6_suffix_128</i> : Specify the ending part of the IPv6 address, a slash (/), and the prefix length. The Zyxel Device appends it to the delegated prefix.  For example, you got a delegated prefix of 2003:1234:5678/48. You want to configure an IP address of 2003:1234:5678:1111::1/128 for this interface, then enter ::1111:0:0:0:1/128 for the <i>dhcp6_suffix_128</i> .
ipv6 dhcp6 [client]	Sets the IPv6 interface to be a DHCPv6 client.
[no] ipv6 dhcp6 rapid-commit	Shortens the DHCPv6 message exchange process from four to two steps to help reduce network traffic. The <code>no</code> command sets the full four-step DHCPv6 message exchange process.
[no] ipv6 dhcp6 address-request	Get this interface's IPv6 address from the DHCPv6 server. The <code>no</code> command has the Zyxel Device not get this interface's IPv6 address from the DHCPv6 server.
ipv6 dhcp6 duid { <i>duid</i>   <i>mac</i> }	Specify the DHCP Unique Identifier (DUID) of the interface or have it generated from the interface's default MAC address.
[no] ipv6 dhcp6-request-object <i>dhcp6_profile</i>	For a DHCPv6 client interface, specify the profile of DHCPv6 request settings that determine what additional information to get from the DHCPv6 server. The <code>no</code> command removes the DHCPv6 request settings profile.
show interface ppp system-default	Displays system default PPP interfaces (non-deletable) that come with the Zyxel Device.
show interface ppp user-define	Displays all PPP interfaces that were manually configured on the Zyxel Device.

## 16.5.1 PPPoE/PPTP Interface Command Examples

The following commands show you how to configure PPPoE/PPTP interface ppp0 with the following characteristics: base interface ge1, ISP account **Hinet**, local address 1.1.1.1, remote address 2.2.2.2, MTU

1200, upstream bandwidth 345, downstream bandwidth 123, description "I am ppp0", and dialed only when used.

```
Router# configure terminal
Router(config)# interface ppp0
Router(config-if-ppp)# account Hinet
Router(config-if-ppp)# bind ge1
Router(config-if-ppp)# local-address 1.1.1.1
Router(config-if-ppp)# remote-address 2.2.2.2
Router(config-if-ppp)# mtu 1200
Router(config-if-ppp)# upstream 345
Router(config-if-ppp)# downstream 123
Router(config-if-ppp)# connectivity dial-on-demand
Router(config-if-ppp)# description I am ppp0
Router(config-if-ppp)# exit
```

The following commands show you how to connect and disconnect ppp0.

```
Router# interface dial ppp0
Router# interface disconnect ppp0
```

## 16.6 Cellular Interface Specific Commands

Use a 3G (Third Generation) cellular device with the Zyxel Device for wireless broadband Internet access.

Use these commands to add, edit, dial, disconnect, or delete cellular interfaces. When you add a new cellular interface, make sure you enter the account. You must use the `configure terminal` command to enter the configuration mode before you can use these commands.

Table 63 Interface Cellular Commands

COMMAND	DESCRIPTION
[no] <code>interface interface_name</code>	Creates the specified interface if necessary and enters sub-command mode. The <code>no</code> command deletes the specified interface.
<code>account profile_name</code>	Specifies the ISP account for the specified cellular interface.
[no] <code>band {auto wcdma gsm lte}</code>	Sets (or clears) the cellular band that the cellular interface uses.  <code>auto</code> has the Zyxel Device always use the fastest network that is in range.  <code>gsm</code> has this interface only use a 2.5G or 2.75G network (respectively). If you only have a GSM network available to you, you may want to use this so the Zyxel Device does not spend time looking for a WCDMA network.  <code>wcdma</code> has this interface only use a 3G or 3.5G network (respectively). You may want to use this if you want to make sure the interface does not use the GSM network.  <code>lte</code> has this interface only use a 4G LTE network. This option only appears when a USG dongle for 4G technology is inserted.

Table 63 Interface Cellular Commands (continued)

COMMAND	DESCRIPTION
[no] network-selection {auto home}	<p>Home network is the network to which you are originally subscribed.</p> <p>Home has the 3G device connect only to the home network. If the home network is down, the Zyxel Device's 3G Internet connection is also unavailable.</p> <p>Auto is the default setting and allows the 3G device to connect to a network to which you are not subscribed when necessary, for example when the home network is down or another 3G base station's signal is stronger. This is recommended if you need continuous Internet connectivity. If you select this, you may be charged using the rate of a different network.</p>
[no] budget active	Sets a monthly limit for the user account of the installed 3G card. You can set a limit on the total traffic and/or call time. The Zyxel Device takes the actions you specified when a limit is exceeded during the month. Use the no command to disable budget control.
[no] budget time active <1..672>	Sets the amount of time (in hours) that the 3G connection can be used within one month. If you change the value, the Zyxel Device resets the statistics. Use the no command to disable time budget control.
[no] budget data active {download-upload download upload} <1..100000>	<p>Sets how much downstream and/or upstream data (in Mega bytes) can be transmitted via the 3G connection within one month.</p> <p>download: set a limit on the downstream traffic (from the ISP to the Zyxel Device).</p> <p>upload: set a limit on the upstream traffic (from the Zyxel Device to the ISP).</p> <p>download-upload: set a limit on the total traffic in both directions.</p> <p>If you change the value, the Zyxel Device resets the statistics.</p> <p>Use the no command to disable data budget control.</p>
budget reset-day <0..31>	Sets the date on which the Zyxel Device resets the budget every month. If the date you selected is not available in a month, such as 30th or 31st, the Zyxel Device resets the budget on the last day of the month.
budget reset-counters	Resets the time and data budgets immediately. The count starts over with the 3G connection's full configured monthly time and data budgets. This does not affect the normal monthly budget restart.
budget {log log-alert} [recursive <1..65535>]	Sets the Zyxel Device to create a log (log) or an alert log (log-alert) when the time or data limit is exceeded. You can also specify how often (from 1 to 65535 minutes) to generate a log or an alert.
no budget log	Sets the Zyxel Device to not create a log when the time or data limit is exceeded.
budget new-connection {allow disallow}	Sets to permit (allow) or drop/block (disallow) new 3G connections when the time or data limit is exceeded.

Table 63 Interface Cellular Commands (continued)

COMMAND	DESCRIPTION
<code>budget current-connection {keep drop}</code>	Sets to maintain the existing 3G connection (keep) or disconnect it (drop) when the time or data limit is exceeded. You cannot set budget new-connection to allow and budget current-connection to drop at the same time.  If you set budget new-connection to disallow and budget current-connection to keep, the Zyxel Device allows you to transmit data using the current connection, but you cannot build a new connection if the existing connection is disconnected.
<code>budget percentage {ptime pdata} &lt;0..99&gt;</code>	Sets a percentage (0-99) of time budget (ptime) or data (pdata) limit. When the specified limit is exceeded, the Zyxel Device takes the action configured using the budget {log-percentage log-percentage-alert} command.
<code>budget {log-percentage log-percentage-alert} [recursive &lt;1..65535&gt;]</code>	Sets to have the Zyxel Device create a log (log-percentage) or an alert log (log-percentage-alert) when the set percentage of time budget or data limit is exceeded. You can configure the percentage using the budget percentage command.  You can also set how often (from 1 to 65535 minutes) to send the log or alert.
<code>no budget log-percentage</code>	Sets the Zyxel Device to not create a log when the set percentage of time budget or data limit is exceeded. You can configure the percentage using the budget percentage command.
<code>connectivity {nail-up   dial-on-demand}</code>	Sets the connection to be always on or only when there is traffic.
<code>[no] local-address &lt;ip&gt;</code>	Sets (or clears) the cellular interface's local (own) IP address.
<code>mtu &lt;576..1492&gt;</code>	Sets the Maximum Transmission Unit in bytes.
<code>[no] pin &lt;pin code&gt;</code>	Sets (or clears) the PIN code for the cellular device's 3G card. Use 1-4 alphanumeric characters, underscores (_), or dashes (-).
<code>[no] remote-address &lt;ip&gt;</code>	Sets (or clears) the IP address of the cellular interface's peer (like a gateway or PPPoE server).
<code>interface cellular budget-auto-save &lt;5..1440&gt;</code>	Sets how often (in minutes) the Zyxel Device saves time and data usage records for a connection using the 3G card.
<code>show interface cellular [corresponding-slot device-status support-device]</code>	Shows the status of the specified cellular interface.
<code>show interface cellular corresponding-slot</code>	Shows which cellular interface is on which slot and whether which cellular interface has been configured.
<code>show interface cellular device-status</code>	Displays the installed SIM card and 3G card status.
<code>show interface cellular support-device</code>	Displays all 3G card models the Zyxel Device can support.
<code>show interface cellular budget-auto-save</code>	Displays how often (in minutes) the Zyxel Device records time and data usage of your 3G budgets.
<code>show interface cellular status</code>	Displays the traffic statistics and connection status for your cellular interfaces. See <a href="#">Section 16.6.1 on page 141</a> for all possible cellular status descriptions.

Table 63 Interface Cellular Commands (continued)

COMMAND	DESCRIPTION
<code>show interface <i>interface_name</i> [budget]</code>	Displays the budget control settings for the specified cellular interface.
<code>show interface <i>interface_name</i> device status</code>	Displays the 3G card and SIM card information for the specified cellular interface.
<code>show interface <i>interface_name</i> device profile</code>	Displays the 3G connection profile settings of the specified cellular interface.

## 16.6.1 Cellular Status

The following table describes the different kinds of cellular connection status on the Zyxel Device.

Table 64 Cellular Status

STATUS	DESCRIPTION
No device	no 3G device is connected to the Zyxel Device.
No service	no 3G network is available in the area; you cannot connect to the Internet.
Limited service	returned by the service provider in cases where the SIM card is expired, the user failed to pay for the service and so on; you cannot connect to the Internet.
Device detected	displays when you connect a 3G device.
Device error	a 3G device is connected but there is an error.
Probe device fail	the Zyxel Device's test of the 3G device failed.
Probe device ok	the Zyxel Device's test of the 3G device failed.
Init device fail	the Zyxel Device was not able to initialize the 3G device.
Init device ok	the Zyxel Device initialized the 3G card.
Check lock fail	the Zyxel Device's check of whether or not the 3G device is locked failed.
Device locked	the 3G device is locked.
SIM error	there is a SIM card error on the 3G device.
SIM locked-PUK	the PUK is locked on the 3G device's SIM card.
SIM locked-PIN	the PIN is locked on the 3G device's SIM card.
Unlock PUK fail	Your attempt to unlock a WCDMA 3G device's PUK failed because you entered an incorrect PUK.
Unlock PIN fail	Your attempt to unlock a WCDMA 3G device's PIN failed because you entered an incorrect PIN.
Unlock device fail	Your attempt to unlock a CDMA2000 3G device failed because you entered an incorrect device code.
Device unlocked	You entered the correct device code and unlocked a CDMA2000 3G device.
Get dev-info fail	The Zyxel Device cannot get cellular device information.
Get dev-info ok	The Zyxel Device succeeded in retrieving 3G device information.
Searching network	The 3G device is searching for a network.
Get signal fail	The 3G device cannot get a signal from a network.
Network found	The 3G device found a network.
Apply config	The Zyxel Device is applying your configuration to the 3G device.
Device unready	The 3G interface is disabled.
Active	The 3G interface is enabled.
Incorrect device	The connected 3G device is not compatible with the Zyxel Device.

Table 64 Cellular Status

STATUS	DESCRIPTION
Correct device	The Zyxel Device detected a compatible 3G device.
Set band fail	Applying your band selection was not successful.
Set band ok	The Zyxel Device successfully applied your band selection.
Set profile fail	Applying your ISP settings was not successful.
Set profile ok	The Zyxel Device successfully applied your ISP settings.
PPP fail	The Zyxel Device failed to create a PPP connection for the cellular interface.
Need auth-password	You need to enter the password for the 3G card in the cellular edit screen.
Device ready	The Zyxel Device successfully applied all of your configuration and you can use the 3G connection.

## 16.6.2 Cellular Interface Command Examples

This example shows the configuration of a cellular interface named cellular2 for use with a Sierra Wireless AC850 3G card. It uses only a 3G (or 3.5G) connection, PIN code 1234, an MTU of 1200 bytes, a description of "This is cellular2" and sets the connection to be nailed-up.

```
Router(config)# interface cellular2
Router(config-if-cellular)# device AC850
Router(config-if-cellular)# band wcdma
Router(config-if-cellular)# pin 1234
Router(config-if-cellular)# connectivity nail-up
Router(config-if-cellular)# description This is cellular2
Router(config-if-cellular)# mtu 1200
Router(config-if-cellular)# exit
```

This second example shows specifying a new PIN code of 4567.

```
Router(config)# interface cellular2
Router(config-if-cellular)# pin 4567
Router(config-if-cellular)# exit
```

This example shows the 3G and SIM card information for interface cellular2 on the Zyxel Device.

```
Router(config)# show interface cellular2 device status
interface name: cellular2
extension slot: USB 1
service provider: Chunghwa Telecom
cellular system: WCDMA
signal strength: -95 dBm
signal quality: Poor
device type: WCDMA
device manufacturer: Huawei
device model: E220/E270/E800A
device firmware: 076.11.07.106
device IMEI/ESN: 351827019784694
SIM card IMSI: 466923100565274
```

This example shows the 3G connection profile settings for interface cellular2 on the Zyxel Device. You have to dial \*99\*\*1# to use profile 1, but authentication is not required. Dial \*99\*\*2# to use profile 2 and authentication is required.

```
Router(config)# show interface cellular2 device profile
profile: 1
apn: internet
dial-string: *99**1#
authentication: none
user: n/a
password: n/a
profile: 2
apn: internet
dial-string: *99**2#
authentication: chap
user:
password: ***
-----SNIP!-----
```

## 16.7 Tunnel Interface Specific Commands

The Zyxel Device uses tunnel interfaces in Generic Routing Encapsulation (GRE), IPv6 in IPv4, and 6to4 tunnels. This section covers commands specific to tunnel interfaces. Tunnel interfaces also use many of the general interface commands discussed at the beginning of [Section 16.2 on page 115](#).

Use these commands to add, edit, activate, deactivate, or delete tunnel interfaces. You must use the `configure terminal` command to enter the configuration mode before you can use these commands. GRE mode tunnels support ping check. See [Section 16.2.8 on page 132](#) for more on ping check.

Table 65 interface Tunnel Commands

COMMAND	DESCRIPTION
[no] interface <i>tunnel_iface</i>	Creates the specified interface if necessary and enters sub-command mode. The <code>no</code> command deletes the specified interface.  <i>tunnel_iface</i> : Name of tunnel interface. tunnel([0-3]).
[no] shutdown	Deactivates the specified interface. The <code>no</code> command activates it.
tunnel source [ <i>ipv4 tunnel_bind_interface _any</i> ]	Configures the outer source IP address of the tunneled packets. Specify an IPv4 address or use the IP address of an interface.  <i>_any</i> : Have automatically select the outer source IP. Not available for ipv6ip mode tunnels.
tunnel destination <i>ipv4</i>	Configures the outer destination IP address of the tunneled IPv4 packets.
ip address <i>ipv4 ipv4</i>	Sets the inner source IP of packets sent through the tunnel interface.
tunnel mode ip gre	Sets this interface to use GRE tunnel mode.

Table 65 interface Tunnel Commands (continued)

COMMAND	DESCRIPTION
[no] mtu <576..1480>	Specifies the Maximum Transmission Unit, which is the maximum number of bytes in each packet moving through this interface. The Zyxel Device divides larger packets into smaller fragments. The <b>no</b> command resets the MTU to 1480.
[no] downstream <0..1048576>	Specifies the downstream bandwidth for the specified interface. The <b>no</b> command sets the downstream bandwidth to 1048576.
tunnel mode [ipv6ip [manual   6to4]]	Sets the interface to be an IPv6 over IPv4 tunnel.  manual: Use for a point-to-point manual tunnel for IPv6 transition. You must also configure a policy route for the tunnel.  6to4: Use for a 6to4/6RD automatic tunnel.
ipv6 address <i>ipv6_addr_prefix</i>	Sets an IPv6 address with prefix for the interface.
ipv6 6to4 [prefix <i>ipv6_addr_prefix</i>   destination-prefix <i>ipv4_cidr</i>   relay <i>ipv4</i> ]	For a 6to4 tunnel, sets the IPv6 address with prefix, remote gateway prefix, or relay router IPv4 address.
traffic-prioritize {tcp-ack content-filter dns} bandwidth <0..1048576> priority <1..7> [maximize-bandwidth-usage];	Applies traffic priority when the interface sends TCP-ACK traffic, traffic for querying the content filter, or traffic for resolving domain names. It also sets how much bandwidth the traffic can use and can turn on maximize bandwidth usage.
traffic-prioritize {tcp-ack content-filter dns} priority-code <0..7> deactivate	Turns off traffic priority settings for when the interface sends the specified type of traffic.
exit	Leaves the sub-command mode.
show interface <i>tunnel_iface</i>	Displays the specified tunnel's settings.
show interface tunnel status	Displays the status of the tunnel interfaces.



## 16.7.1 Tunnel Interface Command Examples

This example creates a tunnel interface called tunnel0 that uses wan1 as the source, 168.168.168.168 as the destination, and 10.0.0.100 and 255.255.0.0 as the inner source IP.

```
Router> configure terminal
Router(config)# interface tunnel0
Router(config-if-tunnel)# tunnel source wan1
Router(config-if-tunnel)# tunnel destination 168.168.168.168
Router(config-if-tunnel)# ip address 10.0.0.100 255.255.0.0
Router(config-if-tunnel)# exit

Router(config)# show interface tunnel
tunnel interface: 1
  interface name: tunnel0
  local address: ge2
  local address type: bind
  remote address: 168.168.168.168
  mode: gre
  IP address: 10.0.0.100
  netmask: 255.255.0.0
  status: Inactive
  active: no
```

## 16.8 USB Storage Specific Commands

The Zyxel Device can use a connected USB device to store system logs, diagnostic information and firmware.

Note: The USB device must allow writing (it cannot be read-only) and use the FAT16, FAT32, EXT2, or EXT3 file system.

For Zyxel Devices that have more than one USB port, these commands only apply to the first USB storage device that is attached to the Zyxel Device.

Use these commands to configure settings that apply to the USB storage device connected to the Zyxel Device.

You must be in configuration mode (`configure terminal`) to use the indented commands shown below.

Table 66 USB Storage General Commands

COMMAND	DESCRIPTION
<code>show usb-storage</code>	Displays the status of the connected USB storage device.
<code>[no] usb-storage activate</code>	Enables or disables the connected USB storage service.
<code>usb-storage warn <i>number</i> &lt;percentage   megabyte&gt;</code>	Sets a number and the unit (percentage or megabyte) to have the Zyxel Device send a warning message when the remaining USB storage space is less than the set value.
<code>usb-storage mount</code>	Mounts the connected USB storage device.
<code>usb-storage umount</code>	Unmounts the connected USB storage device.

Table 66 USB Storage General Commands (continued)

COMMAND	DESCRIPTION
[no] logging usb-storage	Sets to have the Zyxel Device log or not log any information about the connected USB storage device(s) for the system log.
show logging status usb-storage	Displays the logging settings for the connected USB storage device.
logging usb-storage category category level <all normal>	Configures the logging settings for the specified category for the connected USB storage device.
logging usb-storage category category disable	Stops logging for the specified category to the connected USB storage device.
logging usb-storage flushThreshold <1..100>	Configures the maximum storage space (in percentage) for storing system logs on the connected USB storage device.
[no] diag-info copy usb-storage	Sets to have the Zyxel Device save or stop saving the current system diagnostics information to the connected USB storage device. You may need to send this file to customer support for troubleshooting.
show diag-info copy usb-storage	Displays whether (enable or disable) the Zyxel Device saves the current system diagnostics information to the connected USB storage device.
[no] corefile copy usb-storage	Sets to have the Zyxel Device save or not save a process's core dump to the connected USB storage device if the process terminates abnormally (crashes). You may need to send this file to customer support for troubleshooting.
show corefile copy usb-storage	Displays whether (enable or disable) the Zyxel Device saves core dump files to the connected USB storage device.

## 16.8.1 Firmware Upgrade via USB Stick

In addition to uploading firmware via the web configurator (see the User's Guide) or console port, you can also upload firmware directly from a USB stick connected to the Zyxel Device.

- 1 Create a folder on the USB stick called '/[ProductName\_dir]/firmware'. For example, if your Zyxel Device is USG110, then create a '/usg110\_dir/firmware/' folder on the stick.
- 2 Put one firmware 'bin' file into the firmware folder. Make sure the firmware ID and version number are correct for your model (the firmware ID is in brackets after the firmware version number - for USG100 it is AAPH).

Note: Do not put more than one firmware 'bin' file into the firmware folder.

The firmware version in the USB stick must be different to the currently running firmware. If the firmware on the USB stick is older, then the Zyxel Device will 'upgrade' to the older version. It is recommended that the firmware on the USB stick be the latest firmware version.

- 3 Insert the USB stick into the Zyxel Device. The firmware uploads to the standby system space.
- 4 The **SYS** LED blinks when the Zyxel Device automatically reboots making the upgraded firmware in standby become the running firmware.

Note: If the **startup-config.conf** configuration file has problems and you are upgrading to 4.25 or later firmware, then the Zyxel Device will revert (failover) to the previously running firmware.

If the **startup-config.conf** configuration file has problems and you are upgrading to earlier than 4.25 firmware, then the Zyxel Device uses the new earlier firmware, but generates a log and tries the existing **lastgood.conf** configuration file. If there isn't a **lastgood.conf** configuration file or it also has an error, the Zyxel Device applies the **system-default.conf** configuration file.

You must be in configuration mode (`configure terminal`) to use the indented commands shown below.

Table 67 USB Firmware Upgrade and Space Commands

COMMAND	DESCRIPTION
<code>show usb-storage update-firmware status</code>	Displays if updating firmware from USB storage is allowed.
<code>show usb-storage space</code>	<p>Displays USB storage space details.</p> <p>Criterion Number is 10-99/100-9999 depending on whether you chose percentage/megabyte as the Criterion Unit for available USB storage.</p> <p>status displays whether the USB device connected to the Zyxel Device is none (no USB device connected) / Ready / Unused (USB device connected but not in use).</p> <p>Detail displays whether the USB device connected to the Zyxel Device is none (no USB device connected) / Removing (USB device is being unmounted) / Mounting (USB device is being mounted) / Deactivated (USB device is disabled) / OutOfSpace ((USB device is full).</p> <p>If both status and Detail are none, then no USB device is connected.</p> <p>If Status is Ready and Detail is none, then a USB device is available.</p>
<code>show usb-storage space ftp</code>	Displays total and available FTP space on the RAM memory of the Zyxel Device in /tmp (in bytes). RAM is cleared when the Zyxel Device restarts.
<code>show usb-storage space tmp</code>	Displays total and available space on the Flash memory of the Zyxel Device in /db/etc/zyxel/ftp/tmp/ (in bytes).
<code>show usb-storage space usb</code>	Displays total size of the system link file and available space of the USB device connected to the Zyxel Device in /mnt/usb.
<code>[no] usb-storage update-firmware enable</code>	<p>Enables updating firmware from USB storage.</p> <p>The no command disables updating firmware from USB storage.</p>
<code>usb-storage warn &lt;10..99&gt; percentage</code>	Sets a warning to display when available USB storage falls below the specified percentage.
<code>usb-storage warn &lt;100..9999&gt; megabyte</code>	Sets a warning to display when available USB storage falls below the specified number of megabytes.

## 16.8.2 USB Storage Commands Example

This example shows how to display the status of the connected USB storage device.

```
Router(config)# usb-storage activate
Router(config)# usb-storage mount
Router(config)# usb-storage update-firmware enable
Router(config)# usb-storage warn 50 percentage
Router# show usb-storage
USBStorage Configuration:
Activation: enable
Criterion Number: 50
Criterion Unit: percentage
USB Storage Status:
Device description: UFD 3.0 Silicon-Power32G
Usage: 28.9GB
Filesystem: unknown
Speed: USB 2.0 480Mbps
Status: Unused
Detail: OutOfSpace

Router# show usb-storage space ftp
Total space: 91384832
Remaining space: 42306560
Router# show usb-storage space tmp
Total space: 516079616
Remaining space: 502071296
Router# show usb-storage space usb
Total space: 5
Remaining space: 0
Router#
```

## 16.9 VLAN Interface Specific Commands

This section covers commands that are specific to VLAN interfaces. VLAN interfaces also use many of the general interface commands discussed at the beginning of [Section 16.2 on page 115](#).

The following table identifies the values required for many of these commands. Other input values are discussed with the corresponding commands.

Table 68 Input Values for VLAN Interface Commands

LABEL	DESCRIPTION
<i>interface_name</i>	VLAN interface: $vlanx$ , $x = 0 - 4094$  Ethernet interface: For some Zyxel Device models, use $gex$ , $x = 1 - N$ , where $N$ equals the highest numbered Ethernet interface for your Zyxel Device model.  For other Zyxel Device models use a name such as wan1, wan2, opt, lan1, ext-wlan, or dmz.

This table lists the VLAN interface commands.

Table 69 interface Commands: VLAN Interfaces

COMMAND	DESCRIPTION
<code>interface <i>interface_name</i></code>	Creates the specified interface if necessary and enters sub-command mode.
<code>[no] port <i>interface_name</i></code>	Specifies the Ethernet interface on which the VLAN interface runs. The <code>no</code> command clears the port.
<code>[no] vlan-id &lt;1..4094&gt;</code>	Specifies the VLAN ID used to identify the VLAN. The <code>no</code> command clears the VLAN ID.
<code>[no] priority-code &lt;0..7.</code>	Sets the 802.1p priority for vlan outgoing traffic from 0 to 7 where 0 is the lowest priority (lowest, background traffic) and 7 the highest (network control traffic).
<code>show port vlan-id</code>	Displays the Ethernet interface VLAN settings.

## 16.9.1 VLAN Interface Command Examples

The following commands show you how to set up VLAN `vlan100` with the following parameters: VLAN ID 100, interface `ge1`, IP 1.2.3.4, subnet 255.255.255.0, MTU 598, gateway 2.2.2.2, description "I am vlan100", upstream bandwidth 345, and downstream bandwidth 123.

```
Router# configure terminal
Router(config)# interface vlan100
Router(config-if-vlan)# vlan-id 100
Router(config-if-vlan)# port ge1
Router(config-if-vlan)# ip address 1.2.3.4 255.255.255.0
Router(config-if-vlan)# ip gateway 2.2.2.2
Router(config-if-vlan)# mtu 598
Router(config-if-vlan)# upstream 345
Router(config-if-vlan)# downstream 123
Router(config-if-vlan)# description I am vlan100
Router(config-if-vlan)# exit
```

## 16.10 Bridge Specific Commands

This section covers commands that are specific to bridge interfaces. Bridge interfaces also use many of the general interface commands discussed at the beginning of [Section 16.2 on page 115](#).

The following table identifies the values required for many of these commands. Other input values are discussed with the corresponding commands.

Table 70 Input Values for Bridge Interface Commands

LABEL	DESCRIPTION
<i>interface_name</i>	<p>The name of the interface.</p> <p>Ethernet interface: For some Zyxel Device models use <code>ge<math>x</math></code>, <math>x = 1 - N</math>, where <math>N</math> equals the highest numbered Ethernet interface for your Zyxel Device model.</p> <p>For other Zyxel Device models use a name such as <code>wan1</code>, <code>wan2</code>, <code>opt</code>, <code>lan1</code>, <code>ext-wlan</code>, or <code>dmz</code>.</p> <p>VLAN interface: <code>vlan<math>x</math></code>, <math>x = 0 - 4094</math></p> <p>bridge interface: <code>br<math>x</math></code>, <math>x = 0 - N</math>, where <math>N</math> depends on the number of bridge interfaces your Zyxel Device model supports.</p>

This table lists the bridge interface commands.

Table 71 interface Commands: Bridge Interfaces

COMMAND	DESCRIPTION
<code>interface interface_name</code>	Creates the specified interface if necessary and enters sub-command mode.
<code>[no] join interface_name</code>	Adds the specified Ethernet interface or VLAN interface to the specified bridge. The <code>no</code> command removes the specified interface from the specified bridge.
<code>show bridge available member</code>	Displays the available interfaces that could be added to a bridge.

### 16.10.1 Bridge Interface Command Examples

The following commands show you how to set up a bridge interface named br0 with the following parameters: member ge1, IP 1.2.3.4, subnet 255.255.255.0, MTU 598, gateway 2.2.2.2, upstream bandwidth 345, downstream bandwidth 123, and description "I am br0".

```
Router# configure terminal
Router(config)# interface br0
Router(config-if-brg)# join ge1
Router(config-if-brg)# ip address 1.2.3.4 255.255.255.0
Router(config-if-brg)# ip gateway 2.2.2.2
Router(config-if-brg)# mtu 598
Router(config-if-brg)# upstream 345
Router(config-if-brg)# downstream 123
Router(config-if-brg)# description I am br0
Router(config-if-brg)# exit
```

## 16.11 LAG Commands

This section covers commands that are specific to Link Aggregation Group (LAG) interfaces. LAG is a way to combine multiple physical Ethernet interfaces into a single logical interface. This increases uplink bandwidth. It also increases availability as even if a member link goes down, LAG can continue to transmit and receive traffic over the remaining links.

To configure LAG, configure a link number and specify the member ports in the link. All ports must have the same speed and be in full-duplex mode. You must configure the LAG on both sides of the link and you must set the interfaces on either side of the link to be the same speed.

Note: At the time of writing, up to 4 ports can be grouped into a LAG and up to 4 LAGs can be configured on a Zyxel Device.

The following table identifies the values required for many of these commands. Other input values are discussed with the corresponding commands.

Table 72 Input Values for LAG Interface Commands

LABEL	DESCRIPTION
<i>interface_name</i>	LAG interface: lagx, x = 0 - 4 (at the time of writing).  Ethernet interface: For some Zyxel Device models use gex, x = 1 - N, where N equals the highest numbered Ethernet interface for your Zyxel Device model.  For other Zyxel Device models use a name such as wan1, wan2, opt, lan1, ext-wlan, or dmz.  VLAN interface: vlanx, x = 0 - 4094

This table lists the LAG-specific interface commands. See [Table 50 on page 115](#) for common interface commands.

Table 73 interface Commands: LAG Interfaces

COMMAND	DESCRIPTION
<code>interface interface_name</code>	Creates the specified LAG interface (lag0 for example) and enters sub-command mode.
<code>traffic-prioritize {tcp-ack content-filter dns} bandwidth &lt;0..1048576&gt;;</code>	Applies traffic priority when the interface sends TCP-ACK traffic, traffic for querying the content filter, or traffic for resolving domain names. It also sets how much bandwidth the traffic can use.
<code>traffic-prioritize {tcp-ack content-filter dns} priority-code &lt;0..7&gt; deactivate</code>	Turns off traffic priority settings for when the interface sends the specified type of traffic.
<code>mode {802_3ad   active-backup   balance-alb   mode 802_3ad}</code>	Sets the LAG mode. Mode refers to whether the LAG is acting as follows: <ul style="list-style-type: none"> <li><b>active-backup</b> where only one slave in the LAG interface is active and another slave becomes active only if the active slave fails.</li> <li><b>802_3ad</b> (IEEE 802.3ad Dynamic link aggregation) where Link Aggregation Control Protocol (LACP) negotiates automatic combining of links and balances the traffic load across the LAG link by sending LACP packets to the directly connected device that also implements LACP. The slaves must have the same speed and duplex settings.</li> <li><b>balance-alb</b> (adaptive load balancing) where traffic is distributed according to the current load on each slave by ARP negotiation. Incoming traffic is received by the current slave. If the receiving slave fails, another slave takes over the MAC address of the failed receiving slave.</li> </ul>
<code>[no] slave interface_name</code>	Specifies the member ports in the link. A slave is a physical Ethernet interface that is a member of a LAG. Slaves do not have an IP Address and in some cases share the same MAC address.  The <code>no</code> command removed the member ports from the link.
<code>link-monitoring {arp   mii   none}</code>	Sets link monitoring to be arp, mii or none. <ul style="list-style-type: none"> <li><b>arp</b> monitoring sends ARP queries and uses the reply to know if the link is up and that traffic is flowing over the link</li> <li><b>mii</b> monitoring monitors the state of the local interface; it can't tell if the link can transmit or receive packets.</li> <li><b>none</b> means no link monitoring is done.</li> </ul>

Table 73 interface Commands: LAG Interfaces (continued)

COMMAND	DESCRIPTION
arp {arp-interval <1..1000>   arp-ip-target <W.X.Y.Z>}	Configure for arp Link Monitoring. arp-interval: Specifies the frequency of ARP requests sent to confirm a that slave interface is up. arp-ip-target <W.X.Y.Z>: Specifies the IP address of the link to send ARP queries.
miimon <1..1000>	Configure for mii Link Monitoring. Specifies the link check interval in milliseconds that the system polls the Media Independent Interface (MII) to get status.
xmit-hash-policy {layer2   layer2_3}	Configure for 802.3ad Mode. Specifies the algorithm for slave selection according to the selected TCP/IP layer.
lacp-rate {fast   slow}	Configure for 802.3ad Mode. Specifies the preferred LACPDU packet transmission rate (fast   slow) to request from 802.3ad partner.
updelay <0..1000>	Configure for mii Link Monitoring. Specifies the waiting time in milliseconds to confirm the slave interface status is up.
downdelay <0..1000>	Configure for mii Link Monitoring. Specifies the waiting time in milliseconds to confirm the slave interface status is down.
igmp {activate   direction {downstream   upstream}   version <1..3>}	See <a href="#">Table 51 on page 122</a> for these command descriptions.
ping-check	See <a href="#">Table 57 on page 132</a> for these command descriptions.
type {external   general   internal}	Specifies one of the following option depending on the type of network to which the Zyxel Device is connected or if you want to additionally manually configure some related settings.  <b>internal</b> is for connecting to a local network. Other corresponding configuration options: DHCP server and DHCP relay. The Zyxel Device automatically adds default SNAT settings for traffic flowing from this interface to an external interface.  <b>external</b> is for connecting to an external network (like the Internet). The Zyxel Device automatically adds this interface to the default WAN trunk.  For <b>general</b> , the rest of the screen's options do not automatically adjust and you must manually configure a policy route to add routing and SNAT settings for the interface.
show lag available slaves	Displays the available slaves that could be added to a LAG.
show interface lag	Displays interface details for all LAG interfaces.
show interface lagx	Displays interface details for LAG x.



## 16.11.1 LAG Interface Command Example

The following commands set up a LAG with slaves ge3, ge5 and ge6.

```

Router# configure terminal
Router(config)# interface lag1
Router(config-if-lag)# mode 802_3ad
Router(config-if-lag)# slave ge3
Router(config-if-lag)# slave ge5
Router(config-if-lag)# slave ge6
Router(config-if-lag)# link-monitoring mii
Router(config-if-lag)# miimon 1000
Router(config-if-lag)# xmit-hash-policy layer2
Router(config-if-lag)# lacp-rate fast
Router(config-if-lag)# updelay 500
Router(config-if-lag)# downdelay 500
Router(config-if-lag)# igmp activate
Router(config-if-lag)# type external
Router(config-if-lag)# exit
Router(config)# show lag available slaves
available slave count: 5
available slave: ge1,ge2,ge4,ge7,ge8
Router(config)# show interface lag1
active: yes
interface name: lag1
modifiable: yes
mode: 802.3ad
primary: none
slaves count: 3
slaves: ge3,ge5,ge6
description:
type: external
link monitoring: mii
miimon: 1000
updelay: 500
downdelay: 500
ARP interval: 20
ARP IP target: 0.0.0.0
LACP rate: fast
xmit hash policy: layer2
IP type: static
IP address: 0.0.0.0
netmask: 0.0.0.0
gateway:
metric: 0
igmp active: yes
igmp direction: upstream
igmp version: IGMPv3
upstream: 1048576
downstream: 1048576
MTU: 1500
MSS: 0
tcp-ack traffic prioritize:
  active : yes
  bandwidth : 1048576
  priority : 1
  maximize-bandwidth-usage : yes

```

```

Router(config)# show interface lag
No. Name                Address type IP address      Mode                Active Slaves
=====
1   lag0                 static    0.0.0.0              active-backup      yes
2   lag1                 static    0.0.0.0              802.3ad           yes    ge3, ge5, ge6

```

## 16.12 VTI Commands

IPsec VPN Tunnel Interface (VTI) encrypts or decrypts IPv4 traffic from or to the interface according to the IP routing table.

VTI allows static routes to send traffic over the VPN. The IPsec tunnel endpoint is associated with an actual (virtual) interface. Therefore many interface capabilities such as Policy Route, Static Route, Trunk, and BWM can be applied to the IPsec tunnel as soon as the tunnel is active

Create a trunk using VPN tunnel interfaces for load balancing.

### 16.12.1 Restrictions for IPsec Virtual Tunnel Interface

- IPv4 traffic only
- IPsec tunnel mode only. A shared keyword must not be configured when using tunnel mode.
- With a VTI VPN you do not add local or remote LANs to your VPN configuration.
- For a VTI VPN you should only have one local and one remote WAN.
- A dynamic peer is not supported
- The IPsec VTI is limited to IP unicast and multicast traffic only.

The following table identifies the values required for many of these commands. Other input values are discussed with the corresponding commands.

Table 74 Input Values for VTI Interface Commands

LABEL	DESCRIPTION
<i>interface_name</i>	<p>VTO interface: lagx, where x is a number from 0 to the maximum number of VPN connections allowed for your Zyxel Device model.</p> <p>Ethernet interface: For some Zyxel Device models use gex, x = 1 - N, where N equals the highest numbered Ethernet interface for your Zyxel Device model.</p> <p>For other Zyxel Device models use a name such as wan1, wan2, opt, lan1, ext-wlan, or dmz.</p> <p>VLAN interface: vlanx, x = 0 - 4094</p>

This table lists the LAG-specific interface commands. See [Table 50 on page 115](#) for common interface commands.

Table 75 interface Commands: VTI Interfaces

COMMAND	DESCRIPTION
<code>interface interface_name</code>	Creates the specified VTI interface ( <code>vti1</code> for example) and enters sub-command mode.  Note: You should have created a VPN tunnel for a Vpn Tunnel Interface scenario first.
<code>[no] downstream &lt;0..1048576&gt;</code>	Specifies the downstream bandwidth for the specified interface. The <code>no</code> command sets the downstream bandwidth to 1048576.
<code>[no] ip address ip subnet_mask</code>	Assigns the specified IP address and subnet mask to the specified interface. The <code>no</code> command clears the IP address and the subnet mask.
<code>[no] metric &lt;0..15&gt;</code>	Sets the VTI interface's priority relative to other interfaces. The lower the number, the higher the priority.
<code>[no] ping-check activate</code>	Enables ping check for the specified interface. The <code>no</code> command disables ping check for the specified interface.
<code>ping-check {domain_name   ip}</code>	Specifies what the Zyxel Device pings for the ping check; you can specify a fully-qualified domain name or IP address for the interface.
<code>ping-check {domain_name   ip} period &lt;5..30&gt;</code>	Specifies what the Zyxel Device pings for the ping check and sets the number of seconds between each ping check.
<code>ping-check {domain_name   ip} timeout &lt;1..10&gt;</code>	Specifies what the Zyxel Device pings for the ping check and sets the number of seconds the Zyxel Device waits for a response.
<code>ping-check {domain_name   ip} fail-tolerance &lt;1..10&gt;</code>	Specifies what the Zyxel Device pings for the ping check and sets the number of times the Zyxel Device times out before it stops routing through the specified interface.
<code>ping-check {domain_name   ip} method {icmp   tcp}</code>	Sets how the Zyxel Device checks the connection to the gateway.  <code>icmp</code> : ping the domain name or IP address you specify to make sure it is still available.  <code>tcp</code> : perform a TCP handshake with the domain name or IP address you specify to make sure it is still available.
<code>ping-check {domain_name   ip} port &lt;1..65535&gt;</code>	Specifies the port number to use for a TCP connectivity check.
<code>[no] shutdown</code>	Deactivates the specified interface. The <code>no</code> command activates it.
<code>[no] upstream &lt;0..1048576&gt;</code>	Specifies the upstream bandwidth for the specified interface. The <code>no</code> command sets the upstream bandwidth to 1048576.
<code>[no] ip ospf priority priority</code>	Sets the priority (between 0 and 255) of this interface when the OSPF autonomous area is looking for a Designated Router (DR) or Backup Designated Router (BDR). The highest-priority interface identifies the DR, and the second-highest-priority interface identifies the BDR. Set the priority to zero if the interface can not be the DR or BDR.  The <code>no</code> command sets the priority to 1.
<code>ip ospf cost &lt;1..65535&gt;</code>	Sets the cost (between 1 and 65,535) to route packets through this interface.  The <code>no</code> command sets the priority to 10.

Table 75 interface Commands: VTI Interfaces (continued)

COMMAND	DESCRIPTION
<code>ip ospf dead-interval &lt;1..65535&gt;</code>	Sets how long to wait for hello packets before declaring that the neighbor is dead.  The <code>no</code> command resets the interval.
<code>ip ospf hello-interval &lt;1..65535&gt;</code>	Sets how often to send a hello packet to check if a neighbor is still alive.  The <code>no</code> command resets the interval.
<code>ip ospf retransmit-interval &lt;1..65535&gt;</code>	Sets the time between Link-State Advertisement (LSA) retransmissions to adjacent routers for a given interface.  The <code>no</code> command resets the interval.
<code>[no] ip ospf {authentication-key key8   encrypted-authentication-key encrypted_str}</code>	Sets an authentication method. To exchange OSPF routing information with peer border routers, you must use the same authentication method that they use. The <code>no</code> command disables the configured authentication.  <i>encrypted_str</i> : string used for encryption  <i>key8</i> : key used for authentication and can contain 1-8 alphanumeric characters, underscores, and dashes.
<code>[no] ip ospf message-digest-key &lt;1..255&gt; {md5 dr_authkey_16   encrypted-md5 encrypted_str}</code>	Sets the ID (between 1 and 255) for MD5 authentication and the password (up to 16 alphanumeric characters and the underscore) for text authentication or MD5 authentication of the Designated Router (DR). The <code>no</code> command disables the configured authentication.  <i>dr_authkey_16</i> : password for authentication and can contain 1-16 alphanumeric characters, underscores, and dashes.  <i>encrypted_str</i> : string used for encryption
<code>[no] ip ospf authentication [message-digest   same-as-area]</code>	Uses the default authentication method in the area. disables authentication. The <code>no</code> command disables using the default authentication method in the area.
<code>[no] ip rip {send   receive} version &lt;1..2&gt; [1.2]</code>	Sets the RIP version(s) used for sending or receiving RIP packets. Choices are 1, 2, and 1 and 2.
<code>[no] ip v2-broadcast</code>	Sends RIP-2 packets using subnet broadcasting; otherwise, the Zyxel Device uses multicasting.
<code>[no] igmp direction {upstream   downstream}</code>	Sets the RIP direction  <i>downstream</i> : This interface receives routing information.  <i>upstream</i> : This interface sends routing information.
<code>[no] igmp activate</code>	Allows the Zyxel Device to act as an IGMP proxy for hosts connected on the IGMP downstream interface.
<code>binding interface interface_name crypto-map map_name</code>	Binds the VTI interface to an IPSec SA that uses the VPN Tunnel Interface scenario ( <code>vpn-tunnel-interface</code> )
<code>vpn-interface-restriction activate</code>	Turns on interface restrictions for IPSec VPN traffic.  When the remote IPSec VPN device initiates a VPN tunnel to one of the Zyxel Device's WAN interface, outgoing VPN traffic can only be sent through the WAN interface on which the incoming VPN traffic was received. If the original WAN interface is down or disabled, the Zyxel Device will discard the outgoing VPN traffic instead of forwarding it through another active WAN interface.  Note: The command takes effect after you restart the Zyxel Device.

Table 75 interface Commands: VTI Interfaces (continued)

COMMAND	DESCRIPTION
<code>vpn-interface-restriction deactivate</code>	Turns off interface restrictions for IPSec VPN traffic.  When the WAN interface on which incoming VPN traffic was received has failed or the VPN client is connected to the LAN, the Zyxel Device can forward outgoing VPN traffic via a different interface.  Note: The command takes effect after you restart the Zyxel Device.
<code>show interface vti</code>	Displays interface details for all VTI interfaces.
<code>show interface vtix</code>	Displays interface details for VTI x.
<code>show vpn-interface-restriction status</code>	Displays whether interface restrictions for IPSec VPN traffic is enabled or not.

## 16.12.2 VTI Interface Command Example

The following commands set up a VTI interface with the shown parameters and binds it to an IPSec SA using a VPN Tunnel Interface scenario.

```
Router# configure terminal
Router(config)# interface vti0
Router(config-if-vti)# downstream 10000
Router(config-if-vti)# upstream 10000
Router(config-if-vti)# ip address 1.1.1.1 255.255.255.0
Router(config-if-vti)# metric 5
Router(config-if-vti)# traffic-prioritize content-filter deactivate
Router(config-if-vti)# exit
Router(config)# show interface vti0
interface name: vti0
active: no
vpn rule:
connection: no
IP address: 1.1.1.1
netmask: 255.255.255.0
upstream: 10000
downstream: 10000
metric: 5
Router(config)#
Router(config)# crypto map test
Router(config-crypto test)# scenario vpn-tunnel-interface
Router(config-crypto test)# exit
Router(config)# binding interface vti0 crypto-map test
Router(config)#
```

# CHAPTER 17

## Trunks

This chapter shows you how to configure trunks on your Zyxel Device.

### 17.1 Trunks Overview

You can group multiple interfaces together into trunks to have multiple connections share the traffic load to increase overall network throughput and enhance network reliability. If one interface's connection goes down, the Zyxel Device sends traffic through another member of the trunk. For example, you can use two interfaces for WAN connections. You can connect one interface to one ISP (or network) and connect the another to a second ISP (or network). The Zyxel Device can balance the load between multiple connections. If one interface's connection goes down, the Zyxel Device can automatically send its traffic through another interface.

You can use policy routing to specify through which interface to send specific traffic types. You can use trunks in combination with policy routing. You can also define multiple trunks for the same physical interfaces. This allows you to send specific traffic types through the interface that works best for that type of traffic, and if that interface's connection goes down, the Zyxel Device can still send its traffic through another interface.

### 17.2 Trunk Scenario Examples

Suppose one of the Zyxel Device's interfaces is connected to an ISP that is also your Voice over IP (VoIP) service provider. You may want to set that interface as active and set another interface (connected to another ISP) to passive. This way VoIP traffic goes through the interface connected to the VoIP service provider whenever the interface's connection is up.

Another example would be if you use multiple ISPs that provide different levels of service to different places. Suppose ISP A has better connections to Europe while ISP B has better connections to Australia. You could use policy routing and trunks to send traffic for your European branch offices primarily through ISP A and traffic for your Australian branch offices primarily through ISP B.

## 17.3 Trunk Commands Input Values

The following table explains the values you can input with the `interface-group` commands.

Table 76 interface-group Command Input Values

LABEL	DESCRIPTION
<i>group-name</i>	A descriptive name for the trunk.  Zyxel Device uses up to 31 characters (a-zA-Z0-9_-). The name cannot start with a number. This value is case-sensitive.
<i>interface-name</i>	The name of an interface, it could be an Ethernet, PPP, VLAN or bridge interface. The possible number of each interface type and the abbreviation to use are as follows.  Ethernet interface: For some Zyxel Device models, use <code>ge<math>x</math></code> , $x = 1 - N$ , where $N$ equals the highest numbered Ethernet interface for your Zyxel Device model.  Other Zyxel Device models use a name such as <code>wan1</code> , <code>wan2</code> , <code>opt</code> , <code>lan1</code> , or <code>dmz</code> .  PPPoE/PPTP interface: <code>ppp<math>x</math></code> , $x = 0 - N$ , where $N$ depends on the number of PPPoE/PPTP interfaces your Zyxel Device model supports.  VLAN interface: <code>vlan<math>x</math></code> , $x = 0 - 4094$  bridge interface: <code>br<math>x</math></code> , $x = 0 - N$ , where $N$ depends on the number of bridge interfaces your Zyxel Device model supports.
<i>num</i>	The interface's position in the trunk's list of members <code>&lt;1..8&gt;</code> .
<code>&lt;CR&gt;</code>	Carriage Return (the "enter" key).

## 17.4 Trunk Commands Summary

The following table lists the `interface-group` commands. You must use the `configure terminal` command to enter the configuration mode before you can use these commands. See [Table 76 on page 159](#) for details about the values you can input with these commands.

Table 77 interface-group Commands Summary

COMMAND	DESCRIPTION
<code>show interface-group {system-default user-define group-name}</code>	Displays pre-configured system default trunks, your own user configuration trunks or a specified trunk's settings.
<code>[no] interface-group group-name</code>	Creates a trunk name and enters the trunk sub-command mode where you can configure the trunk. The <code>no</code> command removes the trunk.
<code>algorithm {wrr llf spill-over}</code>	Sets the trunk's load balancing algorithm.
<code>exit</code>	Leaves the trunk sub-command mode.
<code>flush</code>	Deletes a trunk's interface settings.
<code>interface {num append insert num} interface-name [weight &lt;1..10&gt; limit &lt;1..2097152&gt; passive]</code>	This subcommand adds an interface to a trunk. Sets the interface's number. It also sets the interface's weight and spillover limit or sets it to be passive.

Table 77 interface-group Commands Summary (continued)

COMMAND	DESCRIPTION
loadbalancing-index <inbound outbound total>	Use this command only if you use least load first or spill-over as the trunk's load balancing algorithm.  Set either <code>inbound</code> , <code>outbound</code> , or <code>total</code> (outbound and inbound) traffic to which the Zyxel Device will apply the specified algorithm. Outbound traffic means the traffic travelling from an internal interface (ex. LAN) to an external interface (ex. WAN). Inbound traffic means the opposite.
mode {normal trunk}	Sets the mode for a trunk. Do this first in the trunk's sub-command mode.
move <1..8> to <1..8>	Changes the interface order in a trunk.
[no] interface {num interface-name}	Removes an interface from the trunk.
system default-interface-group group-name	Sets the Zyxel Device to first attempt to use the the specified WAN trunk.
[no] system default-snat	Enables or disables Source NAT (SNAT). When SNAT is enabled, the Zyxel Device uses the IP address of the outgoing interface as the source IP address of the packets it sends out through the WAN interfaces.
show system default-snat	Displays whether the Zyxel Device enable SNAT or not. The Zyxel Device performs SNAT by default for traffic going to or from the WAN interfaces.
show system default-interface-group	Displays the WAN trunk the Zyxel Device first attempts to use.

## 17.5 Trunk Command Examples

The following example creates a weighted round robin trunk for Ethernet interfaces ge1 and ge2. The Zyxel Device sends twice as much traffic through ge1.

```
Router# configure terminal
Router(config)# interface-group wrr-example
Router(if-group)# mode trunk
Router(if-group)# algorithm wrr
Router(if-group)# interface 1 ge1 weight 2
Router(if-group)# interface 2 ge2 weight 1
Router(if-group)# exit
Router(config)#
```

The following example creates a least load first trunk for Ethernet interface ge3 and VLAN 5, which will only apply to outgoing traffic through the trunk. The Zyxel Device sends new session traffic through the least utilized of these interfaces.

```
Router# configure terminal
Router(config)# interface-group llf-example
Router(if-group)# mode trunk
Router(if-group)# algorithm llf
Router(if-group)# interface 1 ge3
Router(if-group)# interface 2 vlan5
Router(if-group)# loadbalancing-index outbound
Router(if-group)# exit
Router(config)#
```



The following example creates a spill-over trunk for Ethernet interfaces ge1 and ge3, which will apply to both incoming and outgoing traffic through the trunk. The Zyxel Device sends traffic through ge1 until it hits the limit of 1000 kbps. The Zyxel Device sends anything over 1000 kbps through ge3.

```
Router# configure terminal
Router(config)# interface-group spill-example
Router(if-group)# mode trunk
Router(if-group)# algorithm spill-over
Router(if-group)# interface 1 ge1 limit 1000
Router(if-group)# interface 2 ge3 limit 1000
Router(if-group)# loadbalancing-index total
Router(if-group)# exit
Router(config)#
```

# CHAPTER 18

## Route

This chapter shows you how to configure policies for IP routing and static routes on your Zyxel Device.

### 18.1 Policy Route

Traditionally, routing is based on the destination address only and the Zyxel Device takes the shortest path to forward a packet. IP Policy Routing (IPPR) provides a mechanism to override the default routing behavior and alter the packet forwarding based on the policy defined by the network administrator. Policy-based routing is applied to incoming packets on a per interface basis, prior to the normal routing.

#### 18.1.1 Source Network Address Translation (SNAT)

SNAT allows the Zyxel Device to rewrite the source IP address of packets in a policy route. This means you can make packets coming from an IP address appear to originate from a different IP address.

##### 18.1.1.1 SNAT with the ZyWALL Interface

In firmware version 5.0 and later, you can apply SNAT to packets sent from the ZyWALL interface. This can be used to separate internally generated Zyxel Device traffic from other traffic.

For example: The Zyxel Device has two IP addresses, 6.6.6.6 and 6.6.6.7, on a WAN interface. There is a firewall in front of the Zyxel Device with the following security rules:

- IP address 6.6.6.6 is client traffic. There are no restrictions.
- IP address 6.6.6.7 is Zyxel Device traffic, Packets can only go to \*.myzyxel.com and \*.cloud.zyxel.com.

If clients are connected to LAN1 on the Zyxel Device, then you need to create two policy routes with SNAT enabled:

- Client\_Route - Incoming interface: LAN1, SNAT: 6.6.6.6.
- Device\_Route - Incoming interface: ZyWALL, SNAT: 6.6.6.7.

## 18.2 Policy Route Commands

The following table identifies the values required for many of these commands. Other input values are discussed with the corresponding commands.

Table 78 Input Values for General Policy Route Commands

LABEL	DESCRIPTION
<i>address_object</i>	The name of the IP address (group) object. You may use 1-31 alphanumeric characters, underscores(_), or dashes (-), but the first character cannot be a number. This value is case-sensitive.
<i>address6_object</i>	The name of the IPv6 address (group) object. You may use 1-31 alphanumeric characters, underscores(_), or dashes (-), but the first character cannot be a number. This value is case-sensitive.
<i>interface_name</i>	The name of the interface.  Ethernet interface: Some Zyxel Device models use <i>gex</i> , $x = 1 - N$ , where $N$ equals the highest numbered Ethernet interface for your Zyxel Device model.  Other Zyxel Device models use a name such as <i>wan1</i> , <i>wan2</i> , <i>opt</i> , <i>lan1</i> , <i>ext-wlan</i> , or <i>dmz</i> .  virtual interface on top of Ethernet interface: add a colon (:) and the number of the virtual interface. For example: <i>gex.y</i> , $x = 1 - N$ , $y = 1 - 4$  VLAN interface: <i>vlanx</i> , $x = 0 - 4094$  virtual interface on top of VLAN interface: <i>vlanx.y</i> , $x = 0 - 4094$ , $y = 1 - 12$  bridge interface: <i>brx</i> , $x = 0 - N$ , where $N$ depends on the number of bridge interfaces your Zyxel Device model supports.  virtual interface on top of bridge interface: <i>brx.y</i> , $x =$ the number of the bridge interface, $y = 1 - 4$  PPPoE/PPTP interface: <i>pppx</i> , $x = 0 - N$ , where $N$ depends on the number of PPPoE/PPTP interfaces your Zyxel Device model supports.
<i>policy_number</i>	The number of a policy route. 1 - $X$ where $X$ is the highest number of policy routes the Zyxel Device model supports. See the Zyxel Device's User's Guide for details.
<i>schedule_object</i>	The name of the schedule. You may use 1-31 alphanumeric characters, underscores(_), or dashes (-), but the first character cannot be a number. This value is case-sensitive.
<i>service_name</i>	The name of the service (group). You may use 1-31 alphanumeric characters, underscores(_), or dashes (-), but the first character cannot be a number. This value is case-sensitive.
<i>user_name</i>	The name of a user (group). You may use 1-31 alphanumeric characters, underscores(_), or dashes (-), but the first character cannot be a number. This value is case-sensitive.
<i>destv6</i>	The IPv6 route prefix (subnet address) for the destination.
<i>prefix</i>	The IPv6 prefix length, 0 - 128.
<i>gatewayv6</i>	The IPv6 address of the specified gateway.
<i>ipv6_addr</i>	An IPv6 address.
<i>ipv6_global_addresses</i>	An IPv6 address excluding the link-local address (fe80::).
<i>ipv6_link_local</i>	An fe80:: IPv6 address.

The following table describes the commands available for policy route. You must use the `configure terminal` command to enter the configuration mode before you can use these commands.

Table 79 Command Summary: Policy Route

COMMAND	DESCRIPTION
<code>[no] bwm activate</code>	Globally enables bandwidth management. You must globally activate bandwidth management to have individual policy routes or application patrol policies apply bandwidth management. The <code>no</code> command globally disables bandwidth management.
<code>policy {policy_number   append   insert policy_number}</code>	Enters the policy-route sub-command mode to configure, add or insert a policy.
<code>[no] auto-destination</code>	When you set <code>tunnel</code> as the next-hop type (using the <code>next-hop tunnel</code> command) for this route, you can use this command to have the Zyxel Device use the local network of the peer router that initiated an incoming dynamic IPsec tunnel as the destination address of the policy instead of what you configure by using the <code>destination</code> command. The <code>no</code> command disables the setting.
<code>[no] auto-disable</code>	When you set <code>interface</code> or <code>trunk</code> as the next-hop type (using the <code>next-hop interface</code> or <code>next-hop trunk</code> command) for this route, you can use this command to have the Zyxel Device automatically disable this policy route when the next-hop's connection is down. The <code>no</code> command disables the setting.
<code>conn-check {FQDN   addr   activate}</code>	Turns on the connection check to the gateway identified by its FQDN or IP address.
<code>[no] deactivate</code>	Disables the specified policy. The <code>no</code> command enables the specified policy.
<code>[no] description description</code>	Sets a descriptive name for the policy. The <code>no</code> command removes the name for the policy.
<code>[no] destination {address_object any}</code>	Sets the destination IP address the matched packets must have. The <code>no</code> command resets the destination IP address to the default ( <code>any</code> ). <code>any</code> means all IP addresses.
<code>[no] dscp {any   &lt;0..63&gt;}</code>	Sets a custom DSCP code point (0-63). This is the DSCP value of incoming packets to which this policy route applies. <code>any</code> means all DSCP value or no DSCP marker.
<code>[no] dscp class {default   dscp_class}</code>	Sets a DSCP class. Use <code>default</code> to apply this policy route to incoming packets that are marked with DSCP value 0. Use one of the pre-defined AF classes (including <code>af11-af13</code> , <code>af21-af23</code> , <code>af31-af33</code> , and <code>af41-af43</code> ) to apply this policy route to incoming packets that are marked with the DSCP AF class.  The "af" entries stand for Assured Forwarding. The number following the "af" identifies one of four classes and one of three drop preferences. See <a href="#">Assured Forwarding (AF) PHB for DiffServ on page 168</a> for more details.  <code>dscp_class</code> can set <code>cs0-cs7</code> too.
<code>dscp-marking &lt;0..63&gt;</code>	Sets a DSCP value to have the Zyxel Device apply that DSCP value to the route's outgoing packets.
<code>dscp-marking class {default   dscp_class}</code>	Sets how the Zyxel Device handles the DSCP value of the outgoing packets that match this route. Set this to <code>default</code> to have the Zyxel Device set the DSCP value of the packets to 0. Set this to an "af" class (including <code>af11-af13</code> , <code>af21-af23</code> , <code>af31-af33</code> , and <code>af41-af43</code> ) which stands for Assured Forwarding. The number following the "af" identifies one of four classes and one of three drop preferences. See <a href="#">Assured Forwarding (AF) PHB for DiffServ on page 168</a> for more details.  <code>dscp_class</code> can set <code>cs0-cs7</code> too.

Table 79 Command Summary: Policy Route (continued)

COMMAND	DESCRIPTION
<code>no dscp-marking</code>	Use this command to have the Zyxel Device not modify the DSCP value of the route's outgoing packets.
<code>exit</code>	Leaves the sub-command mode.
<code>[no] interface interface_name</code>	Sets the interface on which the incoming packets are received. The <code>no</code> command resets the incoming interface to the default ( <code>any</code> ). <code>any</code> means all interfaces.  ZyWALL is a default interface which the Zyxel Device uses to send internally generated traffic. For example, the Zyxel Device uses the ZyWALL interface to download device licensing information from MyZyxel, and to send authentication requests to an external RADIUS server.
<code>[no] next-hop {auto gateway address object  interface interface_name  trunk trunk_name tunnel tunnel_name}</code>	Sets the next-hop to which the matched packets are routed. The <code>no</code> command resets next-hop settings to the default ( <code>auto</code> ).
<code>[no] schedule schedule_object</code>	Sets the schedule. The <code>no</code> command removes the schedule setting to the default ( <code>none</code> ). <code>none</code> means any time.
<code>[no] service {service_name any}</code>	Sets the IP protocol. The <code>no</code> command resets service settings to the default ( <code>any</code> ). <code>any</code> means all services.
<code>[no] snat {outgoing-interface address_object}</code>	Applies Source Network Address Translation (SNAT) to packets within the policy route. Each packet's source address is rewritten to the IP address of the outgoing interface or address object.  The <code>no</code> command removes source NAT settings from the rule.  Note: If the address object is a group or range of IP addresses, then the Zyxel Device picks one IP address randomly from the group or range, and then assigns the address permanently to the policy.  Note: In Zyxel Device firmware version 4.60 and earlier, it is not possible to configure this setting if the policy's interface is set to "ZyWALL". In Zyxel Device firmware version 5.0 and later, this limitation is removed.  Note: To configure this setting in the Web Configurator when the policy's interface is set to "ZyWALL", you must use the <code>visibility</code> command. For details, see <a href="#">Section 72.4 on page 586</a> .
<code>[no] source {address_object any}</code>	Sets the source IP address that the matched packets must have. The <code>no</code> command resets the source IP address to the default ( <code>any</code> ). <code>any</code> means all IP addresses.
<code>[no] srcport {profile_name any}</code>	Sets the source port that the matched packets must have. The <code>no</code> command resets the source port to the default ( <code>any</code> ). <code>any</code> means all ports.
<code>[no] sslvpn tunnel_name</code>	Sets the incoming interface to an SSL VPN tunnel. The <code>no</code> command removes the SSL VPN tunnel through which the incoming packets are received.
<code>[no] tunnel tunnel_name</code>	Sets the incoming interface to an IPSec VPN tunnel. The <code>no</code> command removes the IPSec VPN tunnel through which the incoming packets are received.
<code>[no] user user_name</code>	Sets the user name. The <code>no</code> command resets the user name to the default ( <code>any</code> ). <code>any</code> means all users.

Table 79 Command Summary: Policy Route (continued)

COMMAND	DESCRIPTION
<code>policy6 {policy_number   append   insert policy_number}</code>	Enters the IPv6 policy-route sub-command mode to configure, add or insert a policy.
<code>[no] deactivate</code>	Disables the specified policy. The <code>no</code> command enables the specified policy.
<code>[no] description description</code>	Sets a descriptive name for the IPv6 policy. The <code>no</code> command removes the name for the policy.
<code>[no] destination {address6_object any}</code>	Sets the destination IPv6 IP address the matched packets must have. The <code>no</code> command resets the destination IP address to the default ( <code>any</code> ). <code>any</code> means all IP addresses.
<code>[no] dscp {any   &lt;0..63&gt;}</code>	Sets a custom DSCP code point (0-63). This is the DSCP value of incoming packets to which this policy route applies. <code>any</code> means all DSCP value or no DSCP marker.
<code>[no] dscp class {default   dscp_class}</code>	<p>Sets a DSCP class. Use <code>default</code> to apply this policy route to incoming packets that are marked with DSCP value 0. Use one of the pre-defined AF classes (including <code>af11-af13</code>, <code>af21-af23</code>, <code>af31-af33</code>, and <code>af41-af43</code>) to apply this policy route to incoming packets that are marked with the DSCP AF class.</p> <p>The "af" entries stand for Assured Forwarding. The number following the "af" identifies one of four classes and one of three drop preferences. See <a href="#">Assured Forwarding (AF) PHB for DiffServ on page 168</a> for more details.</p> <p><code>dscp_class</code> can set <code>cs0-cs7</code> too.</p>
<code>dscp-marking &lt;0..63&gt;</code>	Sets a DSCP value to have the Zyxel Device apply that DSCP value to the route's outgoing packets.
<code>dscp-marking class {default   dscp_class}</code>	<p>Sets how the Zyxel Device handles the DSCP value of the outgoing packets that match this route. Set this to <code>default</code> to have the Zyxel Device set the DSCP value of the packets to 0. Set this to an "af" class (including <code>af11-af13</code>, <code>af21-af23</code>, <code>af31-af33</code>, and <code>af41-af43</code>) which stands for Assured Forwarding. The number following the "af" identifies one of four classes and one of three drop preferences. See <a href="#">Assured Forwarding (AF) PHB for DiffServ on page 168</a> for more details.</p> <p><code>dscp_class</code> can set <code>cs0-cs7</code> too.</p>
<code>no dscp-marking</code>	Use this command to have the Zyxel Device not modify the DSCP value of the route's outgoing packets.
<code>exit</code>	Leaves the sub-command mode.
<code>[no] interface interface_name</code>	Sets the interface on which the matched packets are received. The <code>no</code> command resets the incoming interface to the default ( <code>any</code> ). <code>any</code> means all interfaces.
<code>[no] next-hop {auto gateway address_object  interface interface_name  trunk trunk_name tunnel tunnel_name}</code>	Sets the next-hop to which the matched packets are routed. The <code>no</code> command resets next-hop settings to the default ( <code>auto</code> ).
<code>[no] schedule schedule_object</code>	Sets the schedule. The <code>no</code> command removes the schedule setting to the default ( <code>none</code> ). <code>none</code> means any time.
<code>[no] service {service_name any}</code>	Sets the IP protocol. The <code>no</code> command resets service settings to the default ( <code>any</code> ). <code>any</code> means all services.
<code>[no] source {address6_object any}</code>	Sets the source IPv6 IP address that the matched packets must have. The <code>no</code> command resets the source IP address to the default ( <code>any</code> ). <code>any</code> means all IP addresses.
<code>[no] srcport {profile_name any}</code>	Sets the source port that the matched packets must have. The <code>no</code> command resets the source port to the default ( <code>any</code> ). <code>any</code> means all ports.

Table 79 Command Summary: Policy Route (continued)

COMMAND	DESCRIPTION
[no] tunnel <i>tunnel_name</i>	Sets the incoming interface to an IPsec VPN tunnel. The <code>no</code> command removes the IPsec VPN tunnel through which the incoming packets are received.
[no] user <i>user_name</i>	Sets the user name. The <code>no</code> command resets the user name to the default (any). <code>any</code> means all users.
[no] policy controll-ipsec-dynamic-rules activate	Enables the Zyxel Device to use policy routes to manually specify the destination addresses of dynamic IPsec rules. You must manually create these policy routes. The Zyxel Device automatically obtains source and destination addresses for dynamic IPsec rules that do not match any of the policy routes.  The <code>no</code> command has the Zyxel Device automatically obtain source and destination addresses for all dynamic IPsec rules.
policy default-route	Enters the policy-route sub-command mode to set a route with the name "default-route".
policy delete <i>policy_number</i>	Removes a routing policy.
policy flush	Clears the policy routing table.
policy list table	Displays all policy route settings.
policy move <i>policy_number</i> to <i>policy_number</i>	Moves a routing policy to the number that you specified.
[no] policy override-direct-route activate	Has the Zyxel Device forward packets that match a policy route according to the policy route instead of sending the packets to a directly connected network. Use the <code>no</code> command to disable it.
[no] policy controll-virtual-server-rules activate	Gives policy routes priority over NAT virtual server rules (1-1 SNAT). Use the <code>no</code> command to give NAT virtual server rules priority over policy routes.
[no] policy6 override-direct-route activate	Has the Zyxel Device forward IPv6 packets that match a policy route according to the policy route instead of sending the packets to a directly connected network. Use the <code>no</code> command to disable it.
show bwm activation	Displays whether or not the global setting for bandwidth management on the Zyxel Device is enabled.
show bwm-usage < [policy-route <i>policy_number</i> ]   [interface <i>interface_name</i> ]	Displays the specified policy route or interface's bandwidth allotment, current bandwidth usage, and bandwidth usage statistics.
show policy-route [ <i>policy_number</i> ]	Displays all or specified policy route settings.
show policy-route begin <1..200> end <1..200>	Displays the specified range of policy route settings.
show policy-route conn-check	Displays the policy route for the connection check.
show policy-route conn-check [ <i>policy_number</i> ]	Displays the specified policy route for the connection check.
show policy-route conn-check status [ <i>policy_number</i> ]	Displays the connection check status for the specified policy route.
show policy-route controll-ipsec-dynamic-rules	Displays whether the Zyxel Device checks policy routes first before IPsec dynamic rules.
show policy-route override-direct-route	Displays whether or not the Zyxel Device forwards packets that match a policy route according to the policy route instead of sending the packets to a directly connected network.
show policy-route controll-virtual-server-rules	Displays whether or not policy routes have priority over NAT virtual server rules (1-1 SNAT).

Table 79 Command Summary: Policy Route (continued)

COMMAND	DESCRIPTION
<code>show policy-route6 override-direct-route</code>	Displays whether or not the Zyxel Device forwards IPv6 packets that match a policy route according to the policy route instead of sending the packets to a directly connected network.
<code>show policy-route rule_count</code>	Displays the number of policy routes that have been configured on the Zyxel Device.
<code>show policy-route underlayer-rules</code>	Displays all policy route rule details for advanced debugging.
<code>show policy-route6 [policy_number]</code>	Displays all or specified IPv6 policy route settings.
<code>show policy-route6 begin &lt;1..200&gt; end &lt;1..200&gt;</code>	Displays the specified range of IPv6 policy route settings.
<code>show policy-route6 controll-ipsec-dynamic-rules</code>	Displays whether the Zyxel Device checks IPv6 policy routes first before IPsec dynamic rules.
<code>show policy-route6 rule_count</code>	Displays the number of IPv6 policy routes that have been configured on the Zyxel Device.

## 18.2.1 Assured Forwarding (AF) PHB for DiffServ

Assured Forwarding (AF) behavior is defined in RFC 2597. The AF behavior group defines four AF classes. Inside each class, packets are given a high, medium or low drop precedence. The drop precedence determines the probability that routers in the network will drop packets when congestion occurs. If congestion occurs between classes, the traffic in the higher class (smaller numbered class) is generally given priority. Combining the classes and drop precedence produces the following twelve DSCP encodings from AF11 through AF43. The decimal equivalent is listed in brackets.

Table 80 Assured Forwarding (AF) Behavior Group

	CLASS 1	CLASS 2	CLASS 3	CLASS 4
Low Drop Precedence	AF11 (10)	AF21 (18)	AF31 (26)	AF41 (34)
Medium Drop Precedence	AF12 (12)	AF22 (20)	AF32 (28)	AF42 (36)
High Drop Precedence	AF13 (14)	AF23 (22)	AF33 (30)	AF43 (38)

## 18.2.2 Policy Route Command Example

The following commands create two address objects (TW\_SUBNET and GW\_1) and insert a policy that routes the packets (with the source IP address TW\_SUBNET and any destination IP address) through the



interface ge1 to the next-hop router GW\_1. This route uses the IP address of the outgoing interface as the matched packets' source IP address.

```
Router(config)# address-object TW_SUBNET 192.168.2.0 255.255.255.0
Router(config)# address-object GW_1 192.168.2.250
Router(config)# policy insert 1
Router(policy-route)# description example
Router(policy-route)# destination any
Router(policy-route)# interface ge1
Router(policy-route)# next-hop gateway GW_1
Router(policy-route)# snat outgoing-interface
Router(policy-route)# source TW_SUBNET
Router(policy-route)# exit
Router(config)# show policy-route 1
index: 1
  active: yes
  auto-disable: no
  description: example
  user: any
  schedule: none
  interface: ge1
  tunnel: none
  sslvpn: none
  source: TW_SUBNET
  destination: any
  DSCP code: any
  service: any
  srcport: any
  nexthop type: Gateway
  nexthop: GW_1
  nexthop state: Not support
  auto destination: no
  SNAT: outgoing-interface
  DSCP marking: preserve
  connectivity-check: no
Router(config)#
```

## 18.3 IP Static Route

The Zyxel Device has no knowledge of the networks beyond the network that is directly connected to the Zyxel Device. For instance, the Zyxel Device knows about network **N2** in the following figure through gateway **R1**. However, the Zyxel Device is unable to route a packet to network **N3** because it doesn't know that there is a route through the same gateway **R1** (via gateway **R2**). The static routes are for you to tell the Zyxel Device about the networks beyond the network connected to the Zyxel Device directly.

Figure 17 Example of Static Routing Topology

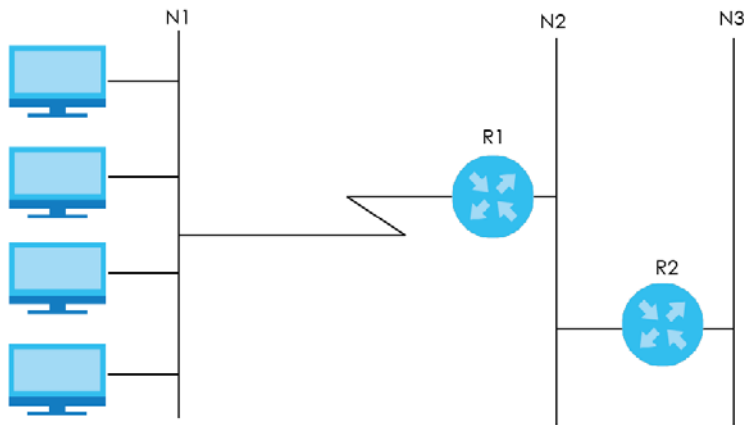

## 18.4 Static Route Commands

The following table describes the commands available for static route. You must use the `configure terminal` command to enter the configuration mode before you can use these commands. See [Section Table 78 on page 163](#) for information on input values.

Table 81 Command Summary: Static Route

COMMAND	DESCRIPTION
<code>[no] ip route {w.x.y.z} {w.x.y.z}</code> <code>{interface w.x.y.z} [&lt;0..127&gt;]</code>	Sets a static route. The <code>no</code> command deletes a static route.
<code>ip route replace {w.x.y.z} {w.x.y.z}</code> <code>{interface w.x.y.z} [&lt;0..127&gt;] with {w.x.y.z}</code> <code>{w.x.y.z} {interface w.x.y.z} [&lt;0..127&gt;]</code>	Changes an existing route's settings.
<code>show ip route-settings</code>	Displays static route information. Use <code>show ip route</code> to see learned route information. See <a href="#">Section 19.2.5 on page 175</a> .
<code>ip6 route destv6/prefix { ipv6_global_address  </code> <code>ipv6_link_local   interface} [&lt;0..127&gt;]</code>	Sets an IPv6 static route.
<code>ip6 route destv6/prefix { ipv6_link_local</code> <code>interface} [&lt;0..127&gt;]</code>	Sets an IPv6 link local static route.
<code>no ip6 route destv6/prefix { gatewayv6   interface}</code> <code>[&lt;0..127&gt;]</code>	Deletes the specified IPv6 static route.
<code>ip6 route replace destv6/prefix { gatewayv6  </code> <code>interface} [&lt;0..127&gt;] with destv6/prefix {</code> <code>gatewayv6   interface} [&lt;0..127&gt;]</code>	Changes an existing IPv6 route's settings.
<code>[no] ip route control-virtual-server-rules</code> <code>activate</code>	Gives static routes priority over NAT virtual server rules (1-1 SNAT). It also automatically gives policy routes priority over NAT virtual server rules. Use the <code>no</code> command to give NAT virtual server rules priority over static routes.
<code>show ip route control-virtual-server-rules</code>	Displays whether or not static routes have priority over NAT virtual server rules (1-1 SNAT).

## 18.4.1 Static Route Commands Examples

The following command sets a static route with IP address 10.10.10.0 and subnet mask 255.255.255.0 and with the next-hop interface ge1. Then use the show command to display the setting.

```
Router(config)# ip route 10.10.10.0 255.255.255.0 ge1
Router(config)#
Router(config)# show ip route-settings
Route          Netmask          Nexthop          Metric
=====
10.10.10.0     255.255.255.0   ge1              0
```

The following commands set and show three examples of static IPv6 routes for traffic destined for IPv6 addresses with prefix 2002:22:22:34::. The first route sends the traffic out through interface ge2 and uses metric 1. The second sends the traffic to gateway 2001:12::12 and uses metric 2. The third sends the traffic to the fe80::1:2 link local gateway on interface ge2 and uses metric 2.

```
Router(config)# ip6 route 2002:22:22:34::/64 ge2 1
Router(config)# ip6 route 2002:22:22:34::/64 2001:12::12 2
/* link-local gateway bind on interface */
Router(config)# ip6 route 2002:22:22:34::/64 fe80::1:2 ge2 2
Router(config)# show ip6 route-settings
No.  Route                               Prefix Length
     Nexthop                               Metric
=====
1    2002:22:22:34:::                     64
     2001:12::12                           2
     2002:22:22:34:::                     64
     ge2                                    1
2    2002:22:22:34:::                     64
     2001:12::12                           2
3    2002:22:22:34:::                     64
     Fe80::1:2                              2
```

The following command deletes a specific static IPv6 route.

```
Router(config)# no ip6 route 2002:22:22:34::/64 2001:12::12
```

The following command deletes all static IPv6 routes with the same prefix.

```
Router(config)# no ip6 route 2002:22:22:34::/64
```

# CHAPTER 19

## Routing Protocol

This chapter describes how to set up RIP and OSPF routing protocols for the Zyxel Device.

### 19.1 Routing Protocol Overview

Routing protocols give the Zyxel Device routing information about the network from other routers. The Zyxel Device then stores this routing information in the routing table, which it uses when it makes routing decisions. In turn, the Zyxel Device can also provide routing information via routing protocols to other routers.

The Zyxel Device supports two standards, RIP and OSPF, for routing protocols. RIP and OSPF are compared in [Table 82 on page 172](#), and they are discussed further in the next two sections.

Table 82 OSPF vs. RIP

	OSPF	RIP
Network Size	Large	Small (with up to 15 routers)
Metric	Bandwidth, hop count, throughput, round trip time and reliability.	Hop count
Convergence	Fast	Slow

### 19.2 Routing Protocol Commands Summary

The following table describes the values required for many routing protocol commands. Other values are discussed with the corresponding commands.

Table 83 Input Values for Routing Protocol Commands

LABEL	DESCRIPTION
<i>ip</i>	The 32-bit name of the area or virtual link in IP address format.
<i>authkey</i>	The password for text or MD5 authentication. You may use alphanumeric characters or underscores(_).  text password: 1-8 characters long  MD5 password: 1-16 characters long

The following sections list the routing protocol commands.

## 19.2.1 RIP Commands

This table lists the commands for RIP.

Table 84 router Commands: RIP

COMMAND	DESCRIPTION
<code>router rip</code>	Enters sub-command mode.
<code>[no] network interface_name</code>	Enables RIP on the specified Ethernet interface. The <code>no</code> command disables RIP on the specified interface.
<code>[no] redistribute {static   ospf}</code>	Enables redistribution of routing information learned from the specified source. The <code>no</code> command disables redistribution from the specified source.
<code>redistribute {static   ospf} metric &lt;0..16&gt;</code>	Sets the metric when redistributing routing information learned from the specified source.
<code>[no] version &lt;1..2&gt;</code>	Sets the default RIP version for all interfaces with RIP enabled. If the interface RIP version is blank, the interface uses the default version. This is not available in the GUI. The <code>no</code> command sets the default RIP version to 2.
<code>[no] passive-interface interface_name</code>	Sets the direction to "In-Only" for the specified interface. The <code>no</code> command sets the direction to bi-directional.
<code>[no] authentication mode {md5   text}</code>	Sets the authentication mode for RIP. The <code>no</code> command sets the authentication mode to "none".
<code>[no] authentication string authkey</code>	Sets the password for text authentication. The <code>no</code> command clears the password.
<code>authentication key &lt;1..255&gt; key-string authkey</code>	Sets the MD5 ID and password for MD5 authentication.
<code>no authentication key</code>	Clears the MD5 ID and password.
<code>[no] outonly-interface interface_name</code>	Sets the direction to "Out-Only" for the specified interface. The <code>no</code> command sets the direction to "BiDir".
<code>encrypted-string ciphertext</code>	Sets the cipher to encrypt the string.

## 19.2.2 General OSPF Commands

This table lists the commands for general OSPF configuration.

Table 85 router Commands: General OSPF Configuration

COMMAND	DESCRIPTION
<code>router ospf</code>	Enters sub-command mode.
<code>[no] redistribute {static   rip}</code>	Enables redistribution of routing information learned from the specified non-OSPF source. The <code>no</code> command disables redistribution from the specified non-OSPF source.
<code>[no] redistribute {static   rip} metric-type &lt;1..2&gt; metric &lt;0..16777214&gt;</code>	Sets the metric for routing information learned from the specified non-OSPF source. The <code>no</code> command clears the metric.
<code>[no] passive-interface interface_name</code>	Sets the direction to "In-Only" for the specified interface. The <code>no</code> command sets the direction to "BiDir".
<code>[no] router-id IP</code>	Sets the 32-bit ID (in IP address format) of the Zyxel Device. The <code>no</code> command resets it to "default", or the highest available IP address.

## 19.2.3 OSPF Area Commands

This table lists the commands for OSPF areas.

Table 86 router Commands: OSPF Areas

COMMAND	DESCRIPTION
router ospf	Enters sub-command mode.
[no] network <i>interface</i> area IP	Adds the specified interface to the specified area. The <b>no</b> command removes the specified interface from the specified area.
[no] area IP [{stub   nssa}]	Creates the specified area and sets it to the indicated type. The <b>no</b> command removes the area.
[no] area IP authentication	Enables text authentication in the specified area. The <b>no</b> command disables authentication in the specified area.
[no] area IP authentication message-digest	Enables MD5 authentication in the specified area. The <b>no</b> command disables authentication in the specified area.
[no] area IP authentication authentication-key <i>authkey</i>	Sets the password for text authentication in the specified area. The <b>no</b> command clears the password.
[no] area IP authentication message-digest-key <1..255> md5 <i>authkey</i>	Sets the MD5 ID and password for MD5 authentication in the specified area. The <b>no</b> command clears the MD5 ID and password.

## 19.2.4 Virtual Link Commands

This table lists the commands for virtual links in OSPF areas.

Table 87 router Commands: Virtual Links in OSPF Areas

COMMAND	DESCRIPTION
show ospf area IP virtual-link	Displays information about virtual links for the specified area.
router ospf	
[no] area IP virtual-link IP	Creates the specified virtual link in the specified area. The <b>no</b> command removes the specified virtual link.
[no] area IP virtual-link IP authentication	Enables text authentication in the specified virtual link. The <b>no</b> command disables authentication in the specified virtual link.
[no] area IP virtual-link IP authentication message-digest	Enables MD5 authentication in the specified virtual link. The <b>no</b> command disables authentication in the specified virtual link.
[no] area IP virtual-link IP authentication authentication-key <i>authkey</i>	Sets the password for text authentication in the specified virtual link. The <b>no</b> command clears the password in the specified virtual link.
[no] area IP virtual-link IP authentication message-digest-key <1..255> md5 <i>authkey</i>	Sets the MD5 ID and password for MD5 authentication in the specified virtual link. The <b>no</b> command clears the MD5 ID and password in the specified virtual link.
[no] area IP virtual-link IP authentication same-as-area	Sets the virtual link's authentication method to the area's default authentication.
[no] area IP virtual-link IP authentication-key <i>authkey</i>	Sets the password for text authentication in the specified virtual link. The <b>no</b> command clears the password.
[no] area IP virtual-link IP encrypted-authentication-key < <i>ciphertext</i> >	Sets the ciphertext for text encryption in the specified virtual link. The <b>no</b> command clears the ciphertext.

Table 87 router Commands: Virtual Links in OSPF Areas (continued)

COMMAND	DESCRIPTION
area IP virtual-link IP message-digest-key <1..255> md5 <i>authkey</i>	Sets the MD5 ID and password for MD5 authentication in the specified virtual link.
area IP virtual-link IP message-digest-key <1..255> encrypted-authentication-key	Sets the MD5 ID in the specified virtual link
no area IP virtual-link IP message-digest-key <1..255>	Clears the MD5 ID in the specified virtual link.

## 19.2.5 Learned Routing Information Commands

This table lists the commands to look at learned routing information.

Table 88 ip route Commands: Learned Routing Information

COMMAND	DESCRIPTION
show ip route [kernel   connected   static   ospf   rip   bgp]	Displays learned routing and other routing information.

## 19.2.6 Show IP Route Command Example

The following example shows learned routing information on the Zyxel Device.

```
Router> show ip route
Flags: A - Activated route, S - Static route, C - directly Connected
       O - OSPF derived, R - RIP derived, G - selected Gateway
       ! - reject, B - Black hole, L - Loop

IP Address/Netmask    Gateway          IFace           Metric    Flags
Persist
=====
0.0.0.0/0             172.16.1.254   wan1            0         ASG    -
10.59.0.0/24          0.0.0.0        ext-wlan        0         ACG    -
127.0.0.0/8           0.0.0.0        lo              0         ACG    -
172.16.1.0/24         0.0.0.0        wan1            0         ACG    -
192.168.1.0/24        0.0.0.0        lan1            0         ACG    -
192.168.2.0/24        0.0.0.0        lan2            0         ACG    -
192.168.3.0/24        0.0.0.0        dmz             0         ACG    -
```

## 19.3 BGP (Border Gateway Protocol)

The Zyxel Device supports eBGP (exterior Border Gate Protocol) to route IPv4 traffic between routers in different Autonomous Systems (AS). An AS number is a number from 1 to 4294967295, that identifies an autonomous system. 4200000000 – 4294967294 are private AS numbers.

You must first allow BGP packets to enter the Zyxel Device from the WAN using the following commands.

```

Router(config)# object-group service Default_Allow_WAN_To_ZyWALL
Router(group-service)# description System Default Allow From WAN To ZyWALL
Router(group-service)# service-object BGP
Router(group-service)# exit
Router(config)# show object-group
Router(config)# show object-group service

```

Group name	Reference	Family
=====		
CU-SEEME	0	Common
DNS	3	Common
IRC	0	Common
NetBIOS	2	Common
ROADRUNNER	0	Common
RTSP	0	Common
SNMP	0	Common
SNMP-TRAPS	0	Common
SSH	0	Common
Default_Allow_ICMPv6_Group	1	V6
Default Allow icmpv6 to ZyWALL		
Default_Allow_WAN_To_ZyWALL	1	Common
System Default Allow From WAN To ZyWALL		
Default_Allow_DMZ_To_ZyWALL	1	Common
System Default Allow From DMZ To ZyWALL		
Default_Allow_v6_WAN_To_ZyWALL	1	Common
System Default Allow IPv6 Form WAN To ZyWALL		
Default_Allow_v6_DMZ_To_ZyWALL	1	Common
System Default Allow IPv6 From DMZ to ZyWALL		
DHCPv6	0	Common
Default_Allow_v6_any_to_ZyWALL	1	V6
System Default Allow IPv6 From any To ZyWALL		

```

Router(config)#

```



## 19.3.1 BGP Commands

This table lists the commands for BGP configuration.

Table 89 bgp Commands

COMMAND	DESCRIPTION
<code>router bgp</code>	Enters router sub-command mode.
<code>[no] as-number &lt;1..4294967295&gt;</code>	Sets the AS number from 1 to 4294967295 in this field. Get the number from your service provider. The Zyxel Device can only belong to one AS at a time.  The <code>no</code> command clears the AS number.
<code>[no] network ipv4_cidr</code>	Add routes that will be announced to all BGP neighbors. You may configure up to 16 network routes.  <i>ipv4_cidr</i> : IPv4 subnet in CIDR format, i.e. 192.168.1.0/32 <W.X.Y.Z>/<1..32>  The <code>no</code> command clears the network.
<code>[no] redistribute connected</code>	Redistributes routes of directly attached devices to the Zyxel Device into the BGP Routing Information Base (RIB)  The <code>no</code> command clears the RIB.
<code>[no] router-id router-id</code>	Sets the IP address of the interface on the Zyxel Device. This field is optional.  The <code>no</code> command clears the router ID.
<code>quit</code>	Leaves sub-command mode.
<code>exit</code>	Leaves sub-command mode.
<code>[no] neighbor ipv4</code>	Sets the IPv4 address of the peer BGP router in a neighboring AS.  <i>ipv4</i> : IPv4 address <W.X.Y.Z>  The <code>no</code> command clears the IPv4 address of the peer BGP router.
<code>[no] neighbor ipv4 description description</code>	Sets a neighbor description to identify the neighbor.  The <code>no</code> command clears the neighbor description.
<code>[no] neighbor ipv4 remote-as &lt;1..4294967295&gt;</code>	Sets the AS number of the neighboring AS.  The <code>no</code> command clears the neighbor AS number.
<code>[no] neighbor ipv4 weight &lt;1..65535&gt;</code>	Specifies a weight value for all routes learned from this peer BGP router in the specified network. The route with the highest weight gets preference.  The <code>no</code> command clears the weight.
<code>[no] neighbor ipv4 ebgp-multihop hops &lt;1..255&gt;</code>	Sets the maximum hop count that the Zyxel Device can attempt for BGP connections to external peers on indirectly connected networks. eBGP neighbors must also perform multihop. Multihop is not established if the only route to the multihop peer is a default route. This avoids loop formation.  The <code>no</code> command forbids the Zyxel Device from attempting BGP connections to external peers on indirectly connected networks.
<code>[no] maximum-paths &lt;1..255&gt;</code>	Sets the maximum number of paths allowed to a peer BGP router in a neighboring AS.  The <code>no</code> command clears the maximum paths.

Table 89 bgp Commands (continued)

COMMAND	DESCRIPTION
[no] neighbor ipv4 timers < 0..65535> < 0..65535>	Sets the interval between each Keepalive message sent by the Zyxel Device and the maximum time the Zyxel Device waits to receive a Keepalive message from a peer BGP router before it declares that the peer BGP router is dead. The interval should be less than the wait time.  The no command clears the timers.
[no] neighbor ipv4 connect-retry	Sets the number of times the Zyxel Device tries to connect to a peer BGP router before it declares that the peer BGP router is dead.  The no command clears the setting.
[no] neighbor ipv4 maximum-prefix < 1..4294967295 >	Sets the maximum number of prefixes, from 1 to 4294967295, of prefixes that can be received from a neighbor. A prefix is a network address (IP/subnet mask) that a BGP router can reach and that it shares with its neighbors. This limits the number of prefixes that the Zyxel Device is allowed to receive from a neighbor. If extra prefixes are received, the Zyxel Device ends the connection with the peer BGP router. You need to edit the peer BGP router configuration to bring the connection back.  The no command clears the maximum number of prefixes.
[no] neighbor ipv4 ttl-security [hops] <1..254>	Sets the maximum number of hops (1 to 254) between the Zyxel Device and a peer BGP router. The Zyxel Device will only accept incoming IP packets with a TTL value that is equal to or greater than the expected value. If the hop count is 3, then the expected incoming TTL value is at least 252, which is 255 minus the TTL value of 3. The Zyxel Device will only accept incoming IP packets from a peer BGP router if it is up to 3 hops away.  The no command clears the hop count.
[no] neighbor ipv4 default-originate	Allows the Zyxel Device to send the default route 0.0.0.0 to peer BGP router for use as a default route.  The no command sends no route as a default.
[no] neighbor ipv4 password password	Sets a default password for MD5 authentication of communication between the Zyxel Device and the peer BGP router. The password can consist of alphanumeric characters and the underscore, and it can be up to 16 characters long.  The no command clears the password.
[no] neighbor ipv4 update-source [ipv4/interface_name]	Allows BGP sessions to use the specified Zyxel Device gateway IP address or Zyxel Device interface for TCP connections.  The no command clears the interface.
show bgp [global   neighbor]	Displays configured BGP Zyxel Device and peer router settings.
show bgp [summary   route   mem]	Displays BGP run time route and memory status.
show ip bgp neighbor ipv4 [advertised-routes   prefix-counts   routes]	Displays route information to the specified peer BGP router.
show ip route bgp	Displays IP Address/Netmask, gateway, interface, metric, flags and persist information.

# CHAPTER 20

## Zones

Set up zones to configure network security and network policies in the Zyxel Device.

### 20.1 Zones Overview

A zone is a group of interfaces and VPN tunnels. The Zyxel Device uses zones, not interfaces, in many security and policy settings, such as firewall rules and remote management.

Zones cannot overlap. Each Ethernet interface, VLAN interface, bridge interface, PPPoE/PPTP interface, and VPN tunnel can be assigned to at most one zone. Virtual interfaces are automatically assigned to the same zone as the interface on which they run.

**Figure 18** Example: Zones

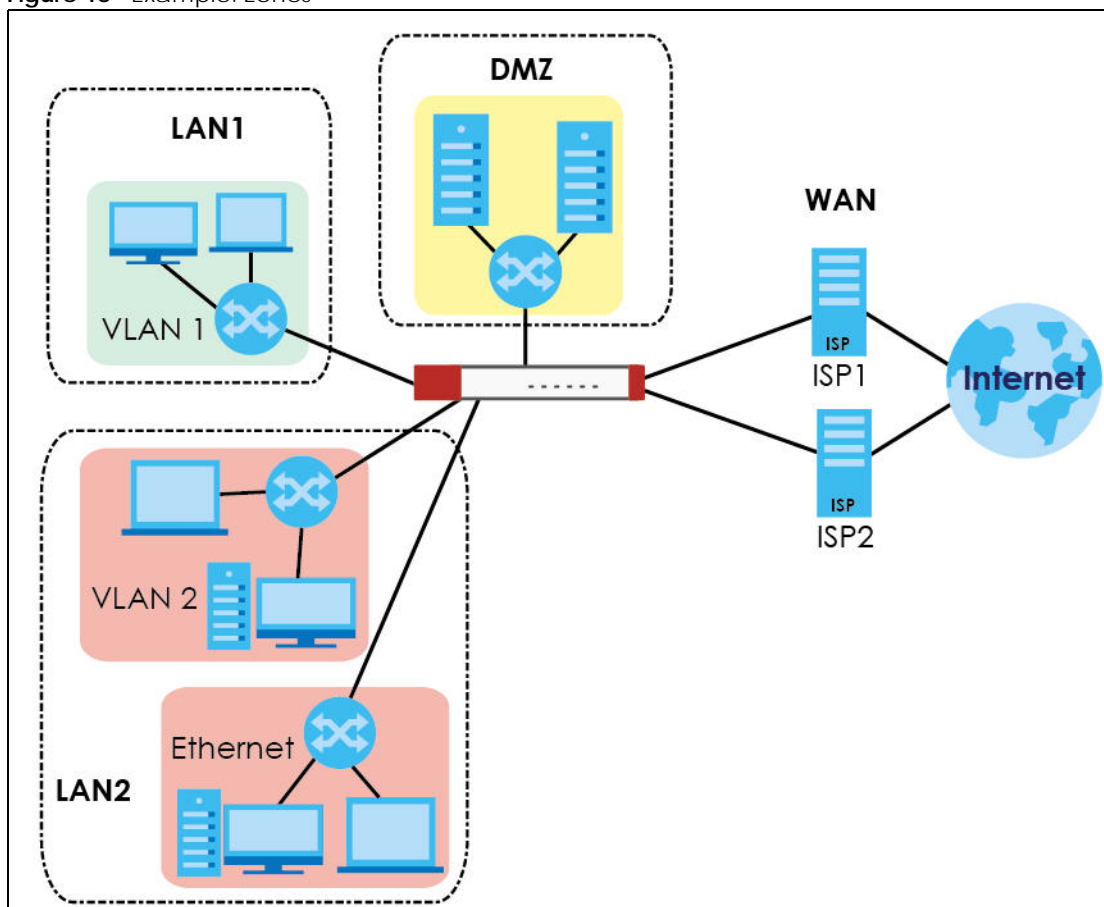

## 20.2 Zone Commands Summary

The following table describes the values required for many zone commands. Other values are discussed with the corresponding commands.

Table 90 Input Values for Zone Commands

LABEL	DESCRIPTION
<i>profile_name</i>	<p>The name of a zone, or the name of a VPN tunnel.</p> <p>For some Zyxel Device models, use up to 31 characters (a-zA-Z0-9_). The name cannot start with a number. This value is case-sensitive.</p> <p>For other Zyxel Device models:</p> <ul style="list-style-type: none"> <li>• The lan1 interface always belongs to the LAN1 zone.</li> <li>• The lan2 interface always belongs to the LAN2 zone.</li> <li>• The dmz interface always belongs to the DMZ zone.</li> <li>• The wan1, wan2, wan1_ppp, or wan2_ppp interfaces always belong to the WAN zone.</li> <li>• An opt_ppp interface can be added to the WAN or OPT zone.</li> </ul>

This table lists the zone commands.

Table 91 zone Commands

COMMAND	DESCRIPTION
show zone <i>[profile_name]</i>	Displays information about the specified zone or about all zones.
show zone binding- iface	Displays each interface and zone mappings.
show zone default- binding	Displays the pre-configured interface and zone mappings that come with the Zyxel Device.
show zone none-binding	Displays the interfaces, tunnels and SSL VPNs that are not associated with a zone yet.
show zone system- default	Displays the pre-configured default zones that you cannot delete from the Zyxel Device.
show zone user-define	Displays all customized zones.
[no] zone <i>profile_name</i>	Creates the zone if necessary and enters sub-command mode. The <b>no</b> command deletes the zone.
zone <i>profile_name</i>	Enter the sub-command mode.
[no] interface <i>interface_name</i>	Adds the specified interface to the specified zone. The <b>no</b> command removes the specified interface from the specified zone. See <a href="#">Section 16.2 on page 115</a> for information about interface names.
[no] crypto <i>profile_name</i>	Adds the specified IPSec VPN tunnel to the specified zone. The <b>no</b> command removes the specified IPSec VPN tunnel from the specified zone.
[no] sslvpn <i>profile_name</i>	Adds the specified SSL VPN tunnel to the specified zone. The <b>no</b> command removes the specified SSL VPN tunnel from the specified zone.

## 20.2.1 Zone Command Examples

The following commands add Ethernet interfaces ge1 and ge2 to zone A.

```
Router# configure terminal
Router(config)# zone A
Router(zone)# interface ge1
Router(zone)# interface ge2
Router(zone)# exit
Router(config)# show zone
No. Name                                     Member
=====
1   A                                       ge1,ge2
Router(config)# show zone A
No. Type                                     Member
=====
1   interface                               ge1
2   interface                               ge2
```

# CHAPTER 21

## DDNS

This chapter describes how to configure dynamic DNS (DDNS) services for the Zyxel Device.

### 21.1 DDNS Overview

DNS maps a domain name to a corresponding IP address and vice versa. Similarly, dynamic DNS maps a domain name to a dynamic IP address. As a result, anyone can use the domain name to contact you (in NetMeeting, CU-SeeMe, etc.) or to access your FTP server or Web site, regardless of the current IP address.

Note: You must have a public WAN IP address to use Dynamic DNS.

Set up a dynamic DNS account with a supported DNS service provider to be able to use Dynamic DNS services with the Zyxel Device. When registration is complete, the DNS service provider gives you a password or key. At the time of writing, the Zyxel Device supports the following DNS service providers. See the listed websites for details about the DNS services offered by each.

Table 92 Network > DDNS

DDNS SERVICE PROVIDER	SERVICE TYPES SUPPORTED	WEBSITE	NOTES
DynDNS	Dynamic DNS, Static DNS, and Custom DNS	www.dyndns.com)	
Dynu	Basic, Premium	www.dynu.com	
No-IP	No-IP	www.no-ip.com	
Peanut Hull	Peanut Hull	www.oray.cn	Chinese website
3322	DynamicDNS, StaticDNS	www.3322.org	Chinese website
Selfhost	Selfhost	selfhoost.de	German website

Note: Record your DDNS account's user name, password, and domain name to use to configure the Zyxel Device.

After, you configure the Zyxel Device, it automatically sends updated IP addresses to the DDNS service provider, which helps redirect traffic accordingly.

## 21.2 DDNS Commands Summary

The following table describes the values required for many DDNS commands. Other values are discussed with the corresponding commands.

Table 93 Input Values for DDNS Commands

LABEL	DESCRIPTION
<i>profile_name</i>	The name of the DDNS profile. You may use 1-31 alphanumeric characters, underscores(_), or dashes (-), but the first character cannot be a number. This value is case-sensitive.

The following table lists the DDNS commands.

Table 94 ip ddns Commands

COMMAND	DESCRIPTION
<code>show ddns [<i>profile_name</i>]</code>	Displays information about the specified DDNS profile or about all DDNS profiles.
<code>show ddns-status</code>	Shows which DDNS profiles are active, inactive or have failed.
<code>[no] ip ddns profile <i>profile_name</i></code>	Creates or edits the specified DDNS profile and enters sub-command mode if necessary. The <code>no</code> command deletes this profile.
<code>[no]https activate</code>	Encrypts traffic using SSL (port 443) to the DDNS server. Not all DDNS providers support this option. The <code>no</code> command disables HTTPS.
<code>[no] service-type {dyndns   dyndns_static   dyndns_custom   dynu-basic   dynu-premium   no-ip   peanut-hull   3322-dyn   3322-static   Selfhost   User custom}</code>	Sets the service type in the specified DDNS profile. The <code>no</code> command clears it.
<code>[no] username <i>username</i> password <i>password</i></code>	Sets the username and password in the specified DDNS profile. The <code>no</code> command clears these fields.  <i>username</i> : You can use up to 31 alphanumeric characters and the underscore (_). <i>password</i> : You can use up to 64 alphanumeric characters and the underscore (_).
<code>[no] host <i>hostname</i></code>	Sets the domain name in the specified DDNS profile. The <code>no</code> command clears the domain name.  <i>hostname</i> : You may up to 254 alphanumeric characters, dashes (-), or periods (.), but the first character must be alphanumeric.
<code>[no] ip-select {iface   auto   custom}</code>	Sets the IP address update policy in the specified DDNS profile. The <code>no</code> command clears the policy.
<code>[no] ip-select-backup {iface   auto   custom}</code>	Sets the alternate IP address update policy in the specified DDNS profile. The <code>no</code> command clears the policy.
<code>[no] custom <i>ip</i></code>	Sets the static IP address in the specified DDNS profile. The <code>no</code> command clears it.
<code>[no] backup-custom <i>ip</i></code>	Sets the static IP address for the backup interface in the specified DDNS profile. The <code>no</code> command clears it.

Table 94 ip ddns Commands (continued)

COMMAND	DESCRIPTION
[no] mx {ip   domain_name}	Enables the mail exchanger and sets the fully-qualified domain name of the mail server to which mail from this domain name is forwarded. The <b>no</b> command disables the mail exchanger.  <i>domain_name</i> : You may up to 254 alphanumeric characters, dashes (-), or periods (.), but the first character must be alphanumeric.
[no] wan-iface interface_name	Sets the WAN interface in the specified DDNS profile. The <b>no</b> command clears it.
[no] backup-iface interface_name	Sets the backup WAN interface in the specified DDNS profile. The <b>no</b> command clears it.
[no] ha-iface interface_name	Sets the HA interface in the specified DDNS profile. The <b>no</b> command clears it.
[no] backmx	Enables the backup mail exchanger. The <b>no</b> command disables it.
[no] wildcard	Enables the wildcard feature. The <b>no</b> command disables it.
[no] url {URL TEXT}	Type the URL that can be used to access the server that will host the DDSN service. For example, # url /api/dynamic/update.php?hostname=home.example.com& ip=10.1.1.1  The <b>no</b> command disables it.
[no] ddns-server {FQDN DNS}	Type the IP address of the server that will host the DDSN service. For example, # ddns-server www.dnspark.net  The <b>no</b> command disables it.
[no] additional-ddns-options	Availalable for User custom. Enter one ofg the following. <ul style="list-style-type: none"> <li>--ip_server_name which should be the URL to get the server's public IP address - for example, http://myip.easylife.tw/</li> <li>--dyndns_system to specify the DYNDNS Server type - for example, dyndns@dyndns.org</li> </ul>

## 21.3 DDNS Commands Example

The following example sets up a DDNS profile where the interface is wan1 and uses HTTP..

```
Router# configure terminal
Router(config)# ip ddns profile bbb
# activate
# service-type user-custom
# username yjyeh001 password xxxxxx
# host yjye007.dyndns.org
# wan-iface wan1
# url /nic/update?
# ddns-server members.dyndns.org
# additional-ddns-options --dyndns_system dyndns@dyndns.org
```



# CHAPTER 22

## Virtual Servers

This chapter describes how to set up, manage, and remove virtual servers. Virtual server commands configure NAT.

### 22.1 Virtual Server Overview

Virtual servers are computers on a private network behind the Zyxel Device that you want to make available outside the private network. If the Zyxel Device has only one public IP address, you can make the computers in the private network available by using ports to forward packets to the appropriate private IP address.

Note: Virtual server is also known as port forwarding or port translation.

#### 22.1.1 1:1 NAT and Many 1:1 NAT

1:1 NAT - If the private network server will initiate sessions to the outside clients, use 1:1 NAT to have the Zyxel Device translate the source IP address of the server's outgoing traffic to the same public IP address that the outside clients use to access the server.

Many 1:1 NAT - If you have a range of private network servers that will initiate sessions to the outside clients and a range of public IP addresses, use many 1:1 NAT to have the Zyxel Device translate the source IP address of each server's outgoing traffic to the same one of the public IP addresses that the outside clients use to access the server. The private and public ranges must have the same number of IP addresses.

One many 1:1 NAT rule works like multiple 1:1 NAT rules, but it eases the configuration effort since you only create one rule.

### 22.2 Virtual Server Commands Summary

The following table describes the values required for many virtual server commands. Other values are discussed with the corresponding commands .

Table 95 Input Values for Virtual Server Commands

LABEL	DESCRIPTION
<i>service_object</i>	The name of a service. You may use 1-31 alphanumeric characters, underscores(_), or dashes (-), but the first character cannot be a number. This value is case-sensitive.
<i>profile_name</i>	The name of the virtual server. You may use 1-31 alphanumeric characters, underscores(_), or dashes (-), but the first character cannot be a number. This value is case-sensitive.

The following table lists the virtual server commands

Note: If you create a NAT rule using the IP address of the Web Configurator and set the external port to 80 or 443, the rule will conflict with the Zyxel Device's default HTTP server port. You will not be able to access the Web Configurator through this interface..

Table 96 ip virtual-server Commands

COMMAND	DESCRIPTION
<code>show ip virtual-server [profile_name]</code>	Displays information about the specified virtual server or about all the virtual servers.
<code>no ip virtual-server profile_name</code>	Deletes the specified virtual server.
<code>ip virtual-server profile_name interface interface_name source-ip {any   IPv4   address-object} original-ip {any   ip   address-object} map-to {address-object   ip} map-type any [nat-loopback [nat-1-1-map] [deactivate]   nat-1-1-map [deactivate]   deactivate]</code>	<p>Creates or modifies the specified virtual server and maps the specified destination IP address (for all destination ports) to <a href="#">the specified destination address object or IP address</a>. The original destination IP is defined by the specified interface (any), the specified IP address (IP), or the specified address object (<i>address-object</i>). NAT loopback allows local users to use a domain name to access this virtual server.</p> <p>The source IP is the source IP address of the incoming packets.</p> <p>The original destination IP is defined by the specified interface (any), the specified IP address (IP), or the specified address object (<i>address-object</i>). NAT loopback allows local users to use a domain name to access this virtual server.</p> <p>Select what kind of NAT this rule is to perform.</p> <p><code>nat-1-1-map</code>: means the NAT type is either 1:1 NAT or many 1:1 NAT. See <a href="#">Section 22.1.1 on page 185</a> for more information.</p> <p>Using this command without <code>nat-1-1-map</code> means the NAT type is Virtual Server. This makes computers on a private network behind the Zyxel Device available to a public network outside the Zyxel Device (like the Internet).</p> <p>The <code>deactivate</code> command disables the virtual server rule.</p>
<code>ip virtual-server profile_name interface interface_name original-ip {any   IP   address-object} map-to {address-object   ip} map-type port protocol {any   tcp   udp} original-port &lt;1..65535&gt; mapped-port &lt;1..65535&gt; [nat-loopback [nat-1-1-map] [deactivate]   nat-1-1-map [deactivate]   deactivate]</code>	<p>Creates or modifies the specified virtual server and maps the specified (destination IP address, protocol, and destination port) to <a href="#">the specified (destination IP address and destination port)</a>. The original destination IP is defined by the specified interface (any), the specified IP address (IP), or the specified address object (<i>address-object</i>). NAT loopback allows local users to use a domain name to access this virtual server.</p> <p><code>nat-1-1-map</code>: means the NAT type is either 1:1 NAT or many 1:1 NAT. See <a href="#">Section 22.1.1 on page 185</a> for more information.</p> <p>Using this command without <code>nat-1-1-map</code> means the NAT type is Virtual Server. This makes computers on a private network behind the Zyxel Device available to a public network outside the Zyxel Device (like the Internet).</p> <p>The <code>deactivate</code> command disables the virtual server rule.</p>
<code>ip virtual-server profile_name interface interface_name original-ip {any   IP   address-object} map-to {address-object   ip} map-type ports protocol {any   tcp   udp} original-port-begin &lt;1..65535&gt; original-port-end &lt;1..65535&gt; mapped-port-begin &lt;1..65535&gt; [nat-loopback [nat-1-1-map] [deactivate]   nat-1-1-map [deactivate]   deactivate]</code>	<p>Creates or modifies the specified virtual server and maps the specified (destination IP address, protocol, and range of destination ports) to <a href="#">the specified (destination IP address and range of destination ports)</a>. The original destination IP is defined by the specified interface (any), the specified IP address (IP), or the specified address object (<i>address-object</i>). NAT loopback allows local users to use a domain name to access this virtual server.</p> <p><code>nat-1-1-map</code>: means the NAT type is either 1:1 NAT or many 1:1 NAT. See <a href="#">Section 22.1.1 on page 185</a> for more information.</p> <p>Using this command without <code>nat-1-1-map</code> means the NAT type is Virtual Server. This makes computers on a private network behind the Zyxel Device available to a public network outside the Zyxel Device (like the Internet).</p> <p>The <code>deactivate</code> command disables the virtual server rule.</p>

Table 96 ip virtual-server Commands (continued)

COMMAND	DESCRIPTION
<pre>ip virtual-server <i>profile_name</i> interface <i>interface_name</i> original-ip {any   IP   <i>address_object</i>} map-to {<i>address_object</i>   <i>ip</i>} map-type <i>original-service</i> <i>service_object</i> mapped-service <i>service_object</i> [nat-loopback [nat-1-1-map] [deactivate]   nat-1-1-map [deactivate]   deactivate]</pre>	<p>Creates or modifies the specified virtual server and maps the specified (destination IP address, protocol, and service object) to <a href="#">the specified (destination IP address and service object)</a>. The original destination IP is defined by the specified interface (any), the specified IP address (IP), or the specified address object (<i>address-object</i>). NAT loopback allows local users to use a domain name to access this virtual server.</p> <p><i>nat-1-1-map</i>: means the NAT type is either 1:1 NAT or many 1:1 NAT. See <a href="#">Section 22.1.1 on page 185</a> for more information.</p> <p>Using this command without <i>nat-1-1-map</i> means the NAT type is Virtual Server. This makes computers on a private network behind the Zyxel Device available to a public network outside the Zyxel Device (like the Internet).</p> <p>The deactivate command disables the virtual server rule.</p>
<pre>ip virtual-server {activate   deactivate} <i>profile_name</i></pre>	<p>Activates or deactivates the specified virtual server.</p>
<pre>ip virtual-server delete <i>profile_name</i></pre>	<p>Deletes the specified virtual server.</p>
<pre>ip virtual-server flush</pre>	<p>Deletes all virtual servers.</p>
<pre>ip virtual-server rename <i>profile_name</i> <i>profile_name</i></pre>	<p>Renames the specified virtual server from the first <i>profile_name</i> to the second <i>profile_name</i>.</p>

## 22.2.1 Virtual Server Command Examples

The following command creates virtual server WAN-LAN\_H323 on the wan1 interface that maps IP addresses 10.0.0.8 to 192.168.1.56. for TCP protocol traffic on port 1720. It also adds a NAT loopback entry.

```
Router# configure terminal
Router(config)# ip virtual-server WAN-LAN_H323 interface wan1 original-ip
10.0.0.8 map-to 192.168.1.56 map-type port protocol tcp original-port 1720
mapped-port 1720 nat-loopback
Router(config)#
```

The following command shows information about all the virtual servers in the Zyxel Device.

```
Router(config)# show ip virtual-server
virtual server: WAN-LAN_H323
  Index: 1
  active: yes
  interface: wan1
  NAT-loopback active: yes
  NAT 1-1: no
  original IP: 10.0.0.8
  mapped IP: 192.168.1.56
  mapping type: port
  protocol type: tcp
  original service:
  mapped service:
  original start port: 1720
  original end port:
  mapped start port: 1720
  mapped end port:
Router(config)#
```

## 22.2.2 Tutorial - How to Allow Public Access to a Server

This is an example of making an HTTP (web) server in the DMZ zone accessible from the Internet (the WAN zone). You will use a public IP address of 1.1.1.2 on the ge2 (or wan1 on some models) interface and map it to the HTTP server's private IP address of 192.168.3.7.

**Figure 19** Public Server Example Network Topology

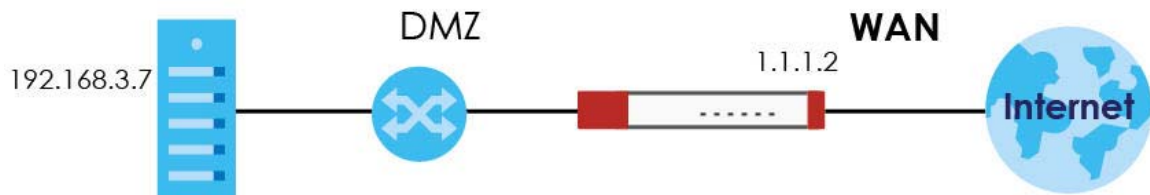

Follow the following steps for the setting.

### 1 Configure Address object

Create two address objects. One is named DMZ\_HTTP for the HTTP server's private IP address of 192.168.3.7. The other one is named ge2\_HTTP for the ge2 (wan1) public IP address of 1.1.1.2.

```
Router# configure terminal
Router(config)# address-object DMZ_HTTP 192.168.3.7
Router(config)# address-object ge2_HTTP 1.1.1.2
Router(config)#
```

### 2 Configure NAT

You need a NAT rule to send HTTP traffic coming to IP address 1.1.1.2 on ge2 (wan1) to the HTTP server's private IP address of 192.168.3.7. Use the following settings:

- This NAT rule is for any HTTP traffic coming in on ge2 (wan1) to IP address 1.1.1.2.

- The NAT rule sends this traffic to the HTTP server's private IP address of 192.168.3.7 (defined in the DMZ\_HTTP object).
- HTTP traffic and the HTTP server in this example both use TCP port 80. So you set the port mapping type to "port", the protocol type to "TCP", and the original and mapped ports to "80".

```
Router(config)# ip virtual-server To-VirtualServer-WWW interface ge2
original-ip ge2_HTTP map-to DMZ_HTTP map-type port protocol tcp original-
port 80 mapped-port 80
Router(config)#
```

### 3 Configure secure policy rule.

Create a firewall rule to allow HTTP traffic from the WAN zone to the DMZ web server.

```
Router(config)# secure-policy insert 1
Router(secure-policy)# description To-VirtualServer-WWW
Router(secure-policy)# from WAN
Router(secure-policy)# to DMZ
Router(secure-policy)# destinationip DMZ_HTTP
Router(secure-policy)# service HTTP
Router(secure-policy)# exit
Router(config)# write
Router(config)#
```

Now the public can go to IP address 1.1.1.2 to access the HTTP server.

## 22.3 Virtual Server Load Balancing

Virtual Server Load balancing allows the Zyxel Device to distribute virtual server connection requests between multiple real (physical) servers. This helps reduce each server's workload and to decrease virtual server response times.

### 22.3.1 Load Balancing Example 1

You are hosting a very popular website on your network, which attracts a lot of traffic and causes problems with your web server. To resolve this, you set up three identical web servers on the DMZ behind the Zyxel Device ([Figure 20 on page 190](#)). The Zyxel Device then distributes incoming requests between the three servers. Clients only see one virtual web server with IP address 1.1.1.2.

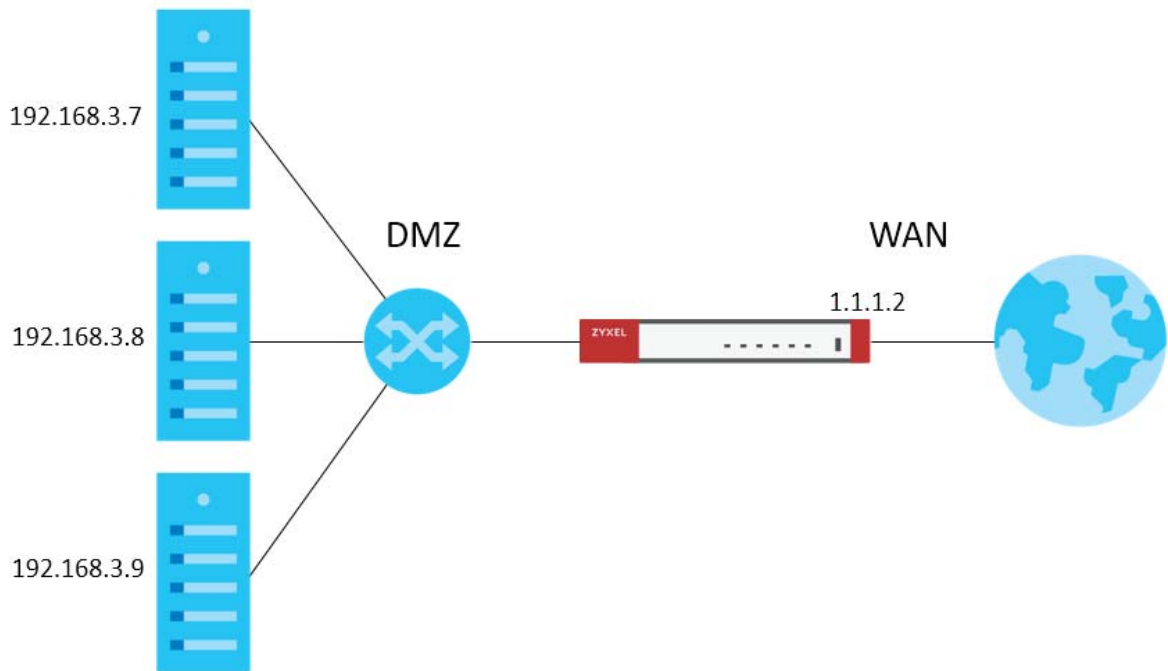
**Figure 20** Virtual Server with Three Real Servers

## 22.3.2 Load Balancing Example 2

You have two internal networks, LAN 1 and LAN 2, that are restricted from accessing each other ([Figure 21 on page 191](#)). LAN 2 hosts two duplicate SMTP mail servers. You want clients on LAN 1 to be able to access the SMTP servers on LAN 2.

You create a virtual server load balancing rule using IP address 10.0.1.100 and port 25, and add two SMTP servers from LAN 2 to the rule. Now clients on LAN 1 can access the virtual server's SMTP service by connecting to 10.0.1.100 port 25. Clients see a single mail server.

Figure 21 Virtual Server on LAN

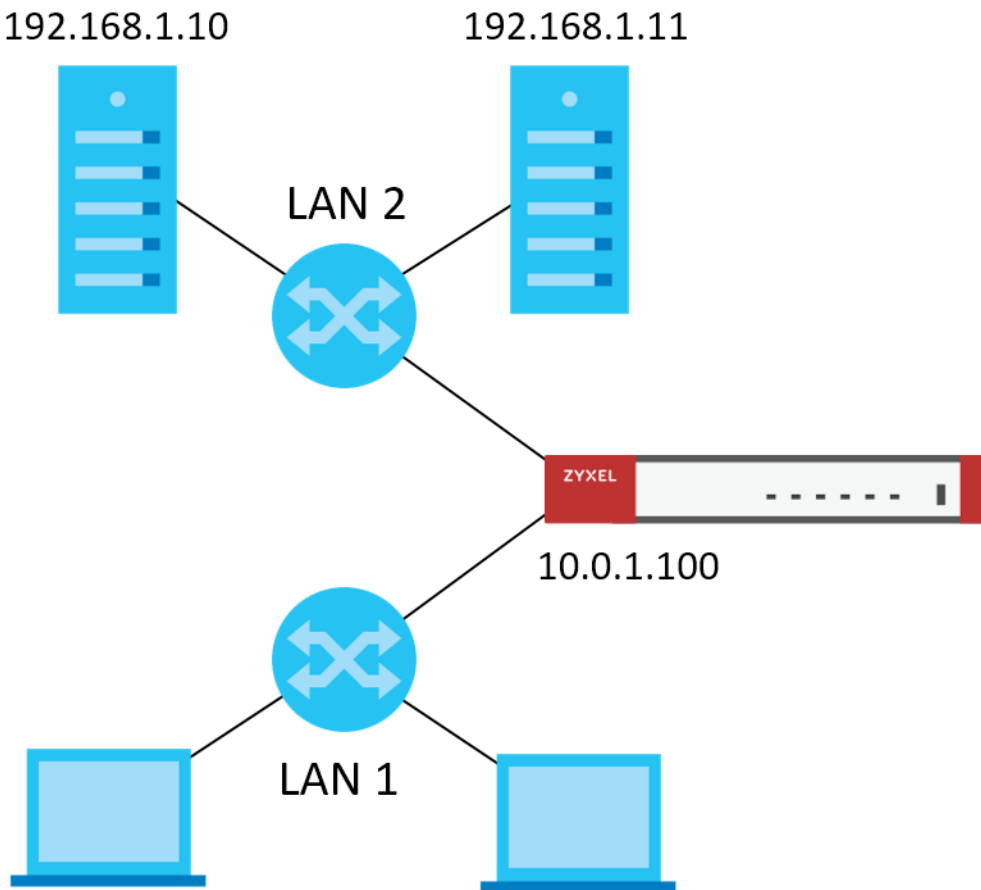

### 22.3.3 Virtual Server Load Balancing Process

The following gives of an overview of how the Virtual Server Load Balancing process works.

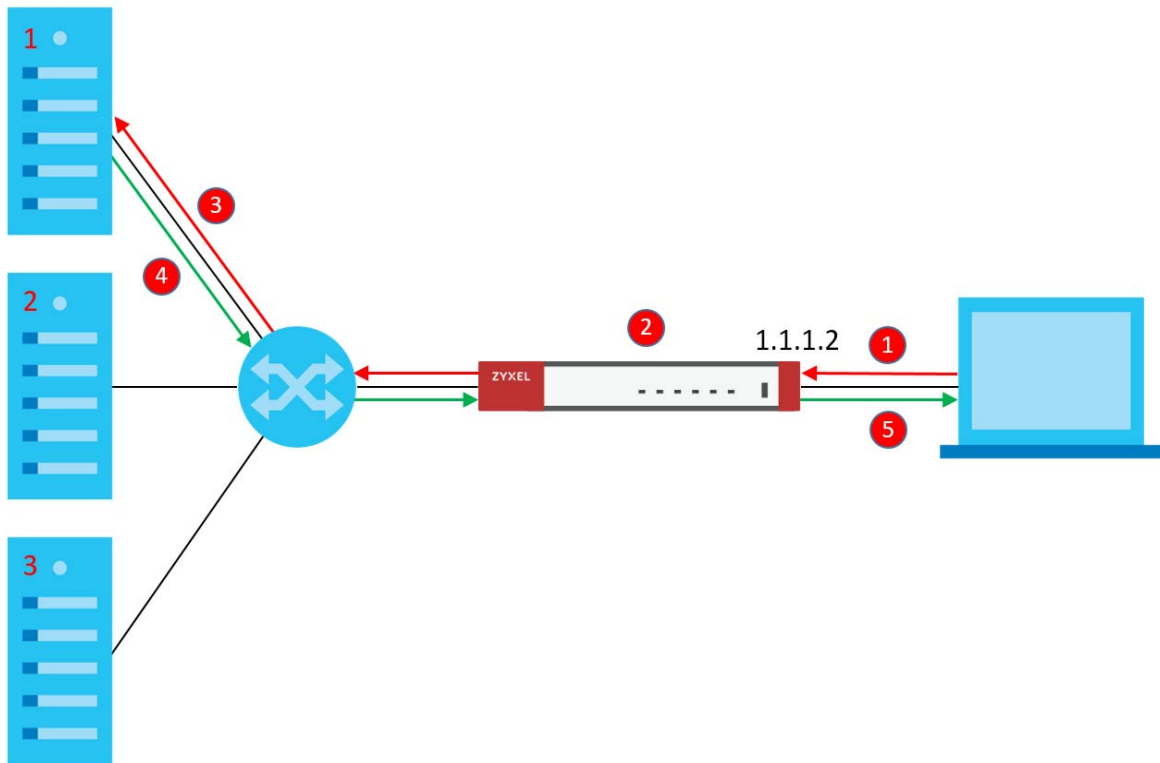
**Figure 22** Load Balancing Overview

- 1 A client connects to the Zyxel Device on IPv4 address 1.1.1.2 (the virtual server external IP address).
- 2 The Zyxel Device matches the connection request to a set of real servers (1, 2, and 3 in [Figure 22 on page 192](#)), and then determines which server will handle the request using a user-specified load balancing algorithm.
- 3 The Zyxel Device forwards the request to the chosen server using NAT.
- 4 The server processes the request, and then replies to the Zyxel Device.
- 5 The Zyxel Device forwards the reply to the client using SNAT.

### 22.3.4 Load Balancing Rules

In order to use load balancing, you must create a load balancing rule. Each load balancing rule consists of an incoming interface, an external IP address, a service type, a load balancing algorithm, and a list of real servers.

Note: One real server can belong to multiple load-balancing rules.

Note: You can only add one interface, IP address, and port to each load balancing rule.

Note: Virtual servers and real servers only support IPv4.



Only certain Zyxel Device models support virtual server load balancing. There are also limits on the maximum number of rules and real servers per Zyxel Device.

Table 97 Virtual Service Load Balancing Limits

PARAMETER	MODEL	LIMIT
Maximum Number of Load Balancing Rules per Zyxel Device	VPN50, USG FLEX 100, USG FLEX 100W, ATP100, ATP100W	5
	VPN100, USG FLEX 200, ATP200	10
	VPN300, USG FLEX 500, ATP500, USG FLEX 700, ATP700, ATP800, VPN1000	20
Maximum Number of Real Servers Per Load Balancing Rule	All of the above models	4

### 22.3.5 Virtual Server Load Balancing Algorithms

A rule's load balancing algorithm determines which real server is assigned to an incoming connection request. When creating a load balancing rule, you can assign each server a weight, which indicates the server's processing capacity compared to other servers.

Table 98 Virtual Server Load Balancing Algorithms

ALGORITHM	DESCRIPTION
Round-Robin	<p>The Zyxel Device assigns servers in the reverse order they were added to the rule (Last In First Out). All servers are considered equal, regardless of their weight and current number of connections.</p> <p>For example, if you have three servers, A, B, C and nine requests, the servers are assigned in the following order: CBACBACBA.</p>
Weighted Round-Robin	<p>The Zyxel Device assigns servers based on a user-specified weight. Servers with a higher weight are assigned before servers with a lower weight. Each time a server is assigned a request, the server's weight decreases by one point until it finishes processing the request.</p> <p>The Zyxel Device assigns servers with equal weight in the reverse order they were added to the rule (Last In First Out). Servers with zero connections are given priority over all other servers.</p> <p>For example, if you have three servers A, B, C with weights 4, 3, 2 and nine requests, the servers are assigned in the following order: CBAABACBA.</p> <p>C (Weights: A4, B3, C2)            CB (Weights: A4, B3, C1)            CBA (Weights: A3, B2, C1)            CBAA (Weights: A2, B2, C1)            CBAAB (Weights: A2, B1, C1)            CBAABA (Weights: A1, B1, C1)            CBAABAC (Weights: A1, B1, C0)            CBAABACB (Weights: A1, B0, C0)            CBAABACBA (Weights: A0, B0, C0)</p>

Table 98 Virtual Server Load Balancing Algorithms

ALGORITHM	DESCRIPTION
Least-Connection	The Zyxel Device assigns the server with the least number of current connections.
Source Hashing / Source IP	<p>The Zyxel Device assigns a server by checking a static hash table, which permanently maps each client IP address to a specific real server.</p> <p>Servers are mapped to new client IP addresses in the reverse order the servers were added to the rule (Last In First Out). Each server is added N times during each sequence, where N is equal to the server's weight.</p> <p>For example, if you have two servers A, and B, with weights 1 and 2, the servers are mapped to new client IP addresses in the hash table in the following order:</p> <p>Source_IP_Hash1 = Server B</p> <p>Source_IP_Hash2 = Server B</p> <p>Source_IP_Hash3 = Server A</p> <p>Source_IP_Hash4 = Server B</p> <p>Source_IP_Hash5 = Server B</p> <p>Source_IP_Hash6 = Server A</p>

## 22.3.6 Virtual Server Load Balancing Commands

The following table describes the virtual server load balancing commands..

Table 99 Virtual Server Load Balancing Commands

Command	DESCRIPTION
<code>ip virtual-server load-balancer name</code>	<p>Enters subcommand mode for the specified load balancing rule.</p> <p>If you rule does not currently exist, then the Zyxel Device creates the rule.</p> <p>The name must consist of 1–31 characters, and may contain letters, numbers, and the following special characters: - (hyphen), _ (underscore).</p>
<code>[no] activate</code>	Enables or disables the load balancing rule.
<pre>virtual-service interface interface_name external-ip {address/object} external-port port protocol {tcp/udp}</pre>	<p>Links the load balancing rule to an incoming interface, an external IPv4 address, and a port. Incoming requests to the IP4 address and port are processing by the load balancing rule.</p> <p><i>interface_name</i>: The name of a device interface, for example wan1. The interface must be one of the following types: Ethernet, VLAN, bridge, PPPoE/PPTP.</p> <p><i>address/object</i>: The IPv4 address of the virtual server. You can enter the IP address manually, for example: 192.168.100.100, or you can enter the name of an IPv4 interface object.</p> <p><i>port</i>: The TCP or UDP port to bind this rule to. Valid range is 1–65535.</p>
<pre>virtual-service interface interface_name external-ip {address/object} external-service service</pre>	<p>Links the load balancing rule to an incoming interface, an external IPv4 address, and a port. Incoming requests to the IP4 address and port are processing by the load balancing rule.</p> <p><i>interface_name</i>: The name of a device interface, for example wan1. The interface must be one of the following types: Ethernet, VLAN, bridge, PPPoE/PPTP.</p> <p><i>address/object</i>: An IPv4 address bound to the interface. You can enter the IP address manually, for example: 192.168.100.100, or you can enter the name of an IPv4 interface object.</p> <p><i>service</i>: The name of a service object, for example SMTP. For details on creating service objects, see <a href="#">Chapter 53 on page 453</a>.</p>

Table 99 Virtual Server Load Balancing Commands

Command	DESCRIPTION
<pre>load-balance- algorithm {rr/wrr/lc/sh}</pre>	<p>Sets the load balancing algorithm for this rule. For information about each algorithm, see <a href="#">Section 22.3.5 on page 193</a>.</p> <ul style="list-style-type: none"> <li><i>rr</i>: Round-Robin</li> <li><i>wrr</i>: Weighted Round-Robin</li> <li><i>lc</i>: Least-Connection</li> <li><i>sh</i>: Source Hashing</li> </ul>
<pre>persistence timeout 1-86400</pre>	<p>Sets how long a client/server session with no activity stays open. Timeout is measured in seconds, and the default value is 360.</p> <p>Multiple requests from a client within a short time period are directed to the same real server, as part of a persistent client/server session.</p> <p>If there are no incoming requests from a client within the specified timeout period, then the persistent client/server session is closed. Further requests from the client might be assigned to a different real server, determined by the load balancing algorithm.</p>
<pre>persistence granularity netmask</pre>	<p>Sets the scope of persistent sessions. The default netmask is 255.255.255.255.</p> <p>By default, the Zyxel Device creates persistent sessions between one client and one server.</p> <p>You can set a netmask to allow a range of clients to open a persistent session with a real server. For example, setting a netmask of 255.255.255.0 means all requests from clients on the subnet 192.168.1.x get directed to the same real server within the timeout period.</p>
<pre>real-server address mapped- port port weight weight [hash hash]</pre>	<p>Adds a real server to the load balancing rule.</p> <p>Note: The real server must offer the service specified when running the <code>virtual-service</code> interface.</p> <p><i>address</i>: IPv4 address of a server on the LAN.</p> <p><i>port</i>: The port on the server that connection requests are forwarded to.</p> <p><i>weight</i>: For algorithm Weighted Round Robin, weight represents the processing power of this server compared to other servers. A server with a weight of 2 is considered to be able to handle two times more connection requests than a server with a weight of 1.</p> <p>For algorithm Source Hashing, servers are mapped to source IP addresses in a hash table proportionally based on the server's weights.</p> <p><i>hash</i>: An MD5 checksum of the webpage specified by <code>http path url</code>. The Zyxel Device uses this checksum to verify that each HTTP health check request returns the correct webpage, and not an error page.</p>
<pre>no real-server address</pre>	<p>Removes the real server from the set of servers managed by this rule.</p>
<pre>[no] health- check activate</pre>	<p>Enables or disables server health checks for this rule.</p> <p>When enabled, the Zyxel Device periodically sends a request to each real server. This request ensures that the server is available, and optionally ensures that a specific service on the server is running.</p>

Table 99 Virtual Server Load Balancing Commands

Command	DESCRIPTION
<pre>health-check type {http / https / tcp / smtp / dns / ping}</pre>	<p>Sets the type of status request to send to each real server.</p> <p>For example, select HTTP and the Zyxel Device periodically sends an HTTP request to each real server, ensuring that the server is available and that its HTTP service is running.</p> <ul style="list-style-type: none"> <li>• HTTP: Web service</li> <li>• HTTPS: Secure web service</li> <li>• TCP: A general network protocol that shows the server is accepting TCP connections</li> <li>• SMTP: Mail service</li> <li>• DNS: Dynamic Name Service</li> <li>• PING: A general network protocol that shows the server is reachable</li> </ul>
<pre>check-period 1- 86400</pre>	<p>Sets the health check time interval, in seconds. The default is 60.</p>
<pre>connect-timeout 1-300</pre>	<p>Sets the period of time in seconds that the Zyxel Device waits after sending a health check request before marking the health check as failed. The default is 5.</p>
<pre>retry 1-99</pre>	<p>Sets the number of times the Zyxel Device resends a health check request before marking the server as unavailable. The default is 1.</p>
<pre>http path url</pre>	<p>Sets the URL to request when the health check type is set to HTTP or HTTPS.</p> <p>Note: If an MD5 checksum is set for a real server, the Zyxel Device uses this checksum to verify that each HTTP health check request returns the correct webpage, and not an error page.</p>
<pre>host sni</pre>	<p>Sets the SNI to send to the real server when the health check type is set to HTTPS.</p> <p>A client sends a Server Name Indication (SNI) when they start an HTTPS session with the server. It allows multiple HTTPS sessions to the same IP address and port number with different certificates with different SNIs.</p>
<pre>[no] hash-auto</pre>	<p>Enables or disables auto-hashing.</p> <p>When enabled, the Zyxel Device sends a HTTP request to each real server, and then calculates and stores the MD5 checksum of the returned webpage.</p> <p>The Zyxel Device uses this checksum to verify that each HTTP health check request returns the correct webpage, and not an error page.</p>
<pre>status-code {int/range}</pre>	<p>Sets which status code indicates a successful reply when the health check type is set to HTTP or HTTPS.</p> <p>The default value is range 200-299.</p>
<pre>[no] https enable-sni</pre>	<p>Enables or disables sending a Server_Name Indication (SNI) as part of the health check request when health check type is set to HTTPS.</p>
<pre>smtp helo-name name</pre>	<p>Sets the HELO string to send to the real server, when the health check type is set to SMTP.</p> <p>Typically, the HELO string contains the fully qualified domain name (FQDN) of the mail server.</p>
<pre>dns query fqdn</pre>	<p>Sets the fully qualified domain name (FQDN) to send to the real server when health check type is set to DNS.</p>
<pre>no ip virtual-server load-balancer name</pre>	<p>Deletes the load balancing rule.</p>
<pre>ip virtual-server load-balancer rename old_name new_name</pre>	<p>Renames the load balancing rule.</p>

Table 99 Virtual Server Load Balancing Commands

Command	DESCRIPTION
<code>show ip virtual-server load-balancer <i>name</i></code>	Displays all of the settings of the specified load balancing rule.
<code>show ip virtual-server load-balancer <i>name</i> real-server</code>	Displays all of the real servers managed by this load balancing rule, with details such as their IP address, port, and weight.
<code>show ip virtual-server load-balancer statistics <i>name</i></code>	Displays statistics about how many requests and how much data each load balancing rule has processed.
<code>show ip virtual-server load-balancer statistics rate <i>name</i></code>	Displays statistics about the average input and output speed for each load balancing rule.

# CHAPTER 23

## HTTP Redirect

This chapter shows you how to configure HTTP redirection on your Zyxel Device.

### 23.1 HTTP Redirect Overview

HTTP redirect forwards the client's HTTP request (except HTTP traffic destined for the Zyxel Device) to a web proxy server.

#### 23.1.1 Web Proxy Server

A proxy server helps client devices make indirect requests to access the Internet or outside network resources/services. A proxy server can act as a firewall or an ALG (application layer gateway) between the private network and the Internet or other networks. It also keeps hackers from knowing internal IP addresses.

### 23.2 HTTP Redirect Commands

The following table identifies the values required for many of these commands. Other input values are discussed with the corresponding commands.

Table 100 Input Values for HTTP Redirect Commands

LABEL	DESCRIPTION
<i>description</i>	The name to identify the rule. You may use 1-31 alphanumeric characters, underscores(_), or dashes (-), but the first character cannot be a number. This value is case-sensitive.
<i>interface_name</i>	The name of the interface.  Ethernet interface: For some Zyxel Device models, use $gex$ , $x = 1 - N$ , where $N$ equals the highest numbered Ethernet interface for your Zyxel Device model.  For other Zyxel Device models use a name such as $wan1$ , $wan2$ , $opt$ , $lan1$ , or $dmz$ .  virtual interface on top of Ethernet interface: add a colon (:) and the number of the virtual interface. For example: $gex:y$ , $x = 1 - N$ , $y = 1 - 4$  VLAN interface: $vlanx$ , $x = 0 - 4094$  virtual interface on top of VLAN interface: $vlanx:y$ , $x = 0 - 4094$ , $y = 1 - 4$  bridge interface: $brx$ , $x = 0 - N$ , where $N$ depends on the number of bridge interfaces your Zyxel Device model supports.  virtual interface on top of bridge interface: $brx:y$ , $x =$ the number of the bridge interface, $y = 1 - 4$  PPPoE/PPTP interface: $pppx$ , $x = 0 - N$ , where $N$ depends on the number of PPPoE/PPTP interfaces your Zyxel Device model supports.

The following table describes the commands available for HTTP redirection. You must use the `configure` terminal command to enter the configuration mode before you can use these commands.

Table 101 Command Summary: HTTP Redirect

COMMAND	DESCRIPTION
<code>ip http-redirect <i>description</i> interface <i>interface_name</i> redirect-to <i>w.x.y.z</i> &lt;1..65535&gt;</code>	Sets a HTTP redirect rule.
<code>ip http-redirect <i>description</i> interface <i>interface_name</i> redirect-to <i>w.x.y.z</i> &lt;1..65535&gt; deactivate</code>	Disables a HTTP redirect rule.
<code>ip http-redirect activate <i>description</i></code>	Enables a rule with the specified rule name.
<code>ip http-redirect deactivate <i>description</i></code>	Disables a rule with the specified rule name.
<code>no ip http-redirect <i>description</i></code>	Removes a rule with the specified rule name.
<code>ip http-redirect flush</code>	Clears all HTTP redirect rules.
<code>show ip http-redirect [<i>description</i>]</code>	Displays HTTP redirect settings.

### 23.2.1 HTTP Redirect Command Examples

The following commands create a HTTP redirect rule, disable it and display the settings.

```
Router# configure terminal
Router(config)# ip http-redirect example1 interface ge1 redirect-to
10.10.2.3 80
Router(config)# ip http-redirect example1 interface ge1 redirect-to
10.10.2.3 80 deactivate
Router(config)# show ip http-redirect
Name                               Interface    Proxy Server    Port    Active
=====
example1                            ge1         10.10.2.3      80     no
```

# CHAPTER 24

## Redirect Service

This chapter shows you how to configure HTTP and SMTP redirection on your Zyxel Device.

### 24.1 HTTP Redirect

HTTP redirect forwards the client's HTTP request (except HTTP traffic destined for the Zyxel Device) to a web proxy server. A proxy server helps client devices make indirect requests to access the Internet or outside network resources/services. The web proxy provides caching service to allow quick access and reduce network usage. The proxy checks its local cache for the requested web resource first. If it is not found, the proxy gets it from the specified server and forwards the response to the client.

### 24.2 SMTP Redirect

SMTP redirect forwards the authenticated client's SMTP message to a SMTP server, that handles all outgoing e-mail messages. The Zyxel Device forwards SMTP traffic using TCP port 25.



## 24.3 Redirect Commands

The following table identifies the values required for many of these commands. Other input values are discussed with the corresponding commands.

Table 102 Input Values for HTTP Redirect Commands

LABEL	DESCRIPTION
<i>profile_name</i>	The name to identify the rule. You may use 1-31 alphanumeric characters, underscores(_), or dashes (-), but the first character cannot be a number. This value is case-sensitive.
<i>interface_name</i>	The name of the interface.  Ethernet interface: For some Zyxel Device models, use <i>gex</i> , <i>x</i> = 1 - N, where N equals the highest numbered Ethernet interface for your Zyxel Device model.  For other Zyxel Device models use a name such as <i>wan1</i> , <i>wan2</i> , <i>opt</i> , <i>lan1</i> , or <i>dmz</i> .  virtual interface on top of Ethernet interface: add a colon (:) and the number of the virtual interface. For example: <i>gex:y</i> , <i>x</i> = 1 - N, <i>y</i> = 1 - 4  VLAN interface: <i>vlanx</i> , <i>x</i> = 0 - 4094  virtual interface on top of VLAN interface: <i>vlanx:y</i> , <i>x</i> = 0 - 4094, <i>y</i> = 1 - 4  bridge interface: <i>brx</i> , <i>x</i> = 0 - N, where N depends on the number of bridge interfaces your Zyxel Device model supports.  virtual interface on top of bridge interface: <i>brx:y</i> , <i>x</i> = the number of the bridge interface, <i>y</i> = 1 - 4  PPPoE/PPTP interface: <i>pppx</i> , <i>x</i> = 0 - N, where N depends on the number of PPPoE/PPTP interfaces your Zyxel Device model supports.
<i>user_name</i>	This is the user account or user group name to which this rule is applied.

The following table describes the commands available for HTTP redirection. You must use the `configure terminal` command to enter the configuration mode before you can use these commands.

Table 103 Command Summary: Redirect

COMMAND	DESCRIPTION
<code>redirect-service append &lt;1..20&gt;</code>	Adds a new Redirect rule and enters sub-command mode.
<code>redirect-service &lt;1..20&gt;</code>	Edits an existing Redirect rule and enters sub-command mode.
<code>[no] activate</code>	Enables the Redirect rule.  The <code>no</code> command disables the Redirect rule.
<code>exit</code>	Leaves sub-command mode
<code>[no] interface interface_name</code>	Names the interface for the Redirect rule.  The <code>no</code> command restores the interface to <code>any</code> .
<code>[no] name profile_name</code>	Names the Redirect rule to identify it.  The <code>no</code> command restores the name to <code>default</code> .
<code>[no] port &lt;1..65535&gt;</code>	Sets the service port for the Redirect rule.  The <code>no</code> command restores the <code>http-redirect</code> port to 80, and the <code>smtp-redirect</code> port to 25.

Table 103 Command Summary: Redirect (continued)

COMMAND	DESCRIPTION
[no] server <fqdn> <w.x.y.z>	Sets the fully-qualified domain name or IPv4 address for the Redirect rule. The <i>no</i> command clears the server.
[no] service {http-redirect   smtp-redirect}	Configures HTTP-redirect or SMTP-redirect as the Redirect rule. The <i>no</i> command restores the service to <i>http-redirect</i> .
[no] source <i>profile_name</i>	Configures the address or address group object. The <i>no</i> command restores the source to <i>any</i> .
[no] user <i>user_name</i>	Configures the user account or user group to which this rule is applied. The <i>no</i> command restores the user to <i>any</i> .
redirect-service flush	Clears all Redirect rules.
redirect-service insert <1..20>	Inserts a new Redirect rule at the specified location and enters sub-command mode.
redirect-service move <1..20> to <1..20>	Moves a Redirect rule to the specified location.
show redirect-service <1..20>	Displays details of the specified Redirect rule.

## 24.3.1 Redirect Command Example

The following commands show how to create and display Redirect service rules on the Zyxel Device.

```
Router(config)# redirect-service append
Router(redirect-service)# interface ge4
Router(redirect-service)# name test
Router(redirect-service)# port 11111
Router(redirect-service)# service smtp-redirect
Router(redirect-service)# server 1.1.1.1
Router(redirect-service)# user admin
Router(redirect-service)# activate
Router(redirect-service)# exit
Router(config)# show redirect-service
redirect service rule: 1
  active: yes
  name: default
  service: http-redirect
  user: any
  incoming interface: any
  source address: any
  server:
  port: 80
  id: 1
redirect service rule: 2
  active: yes
  name: default
  service: http-redirect
  user: any
  incoming interface: any
  source address: any
  server:
  port: 80
  id: 0
redirect service rule: 3
  active: yes
  name: default
  service: append
  user: any
  incoming interface: any
  source address: any
  server:
  port: 80
  id: 2
redirect service rule: 4
  active: yes
  name: test
  service: smtp-redirect
  user: admin
  incoming interface: ge4
  source address: any
  server: 1.1.1.1
  port: 11111
  id: 3
Router(config)#
```

# CHAPTER 25

## ALG

This chapter covers how to use the Zyxel Device's ALG feature to allow certain applications to pass through the Zyxel Device.

### 25.1 ALG Introduction

The Zyxel Device can function as an Application Layer Gateway (ALG) to allow certain NAT un-friendly applications (such as SIP) to operate properly through the Zyxel Device's NAT.

Some applications cannot operate through NAT (are NAT un-friendly) because they embed IP addresses and port numbers in their packets' data payload. The Zyxel Device examines and uses IP address and port number information embedded in the VoIP traffic's data stream. When a device behind the Zyxel Device uses an application for which the Zyxel Device has VoIP pass through enabled, the Zyxel Device translates the device's private IP address inside the data stream to a public IP address. It also records session port numbers and allows the related sessions to go through the firewall so the application's traffic can come in from the WAN to the LAN.

The Zyxel Device only needs to use the ALG feature for traffic that goes through the Zyxel Device's NAT. The firewall allows related sessions for VoIP applications that register with a server. The firewall allows or blocks peer to peer VoIP traffic based on the firewall rules.

You do not need to use a TURN (Traversal Using Relay NAT) server for VoIP devices behind the Zyxel Device when you enable the SIP ALG.

## 25.2 ALG Commands

The following table lists the `alg` commands. You must use the `configure terminal` command to enter the configuration mode before you can use these commands.

Table 104 alg Commands

COMMAND	DESCRIPTION
<code>[no] alg sip [direct-media   direct-signalling   inactivity-timeout   media-timeout &lt;1..86400&gt;   signal-timeout &lt;1..86400&gt;   transformation]</code>	<p>Turns on or configures the ALG.</p> <p>Use <code>direct-media</code> to set the Zyxel Device to allow SIP audio session.</p> <p>Use <code>direct-signalling</code> to set the Zyxel Device to allow SIP signaling sessions.</p> <p>Use <code>inactivity-timeout</code> to have the Zyxel Device apply SIP media and signaling inactivity time out limits.</p> <p>Use <code>media-timeout</code> and a number of seconds (1~86400) for how long to allow a voice session to remain idle (without voice traffic) before dropping it.</p> <p>Use <code>signal-timeout</code> and a number of seconds (1~86400) for how long to allow a SIP signaling session to remain idle (without SIP packets) before dropping it.</p> <p>Use <code>transformation</code> to have the Zyxel Device modify IP addresses and port numbers embedded in the SIP data payload. You do not need to use this if you have a SIP device or server that will modify IP addresses and port numbers embedded in the SIP data payload.</p> <p>The <code>no</code> command turns off the SIP ALG or removes the settings that you specify.</p>
<code>alg sip defaultport</code>	Enters ALG SIP default port sub-command
<code>Router(SIP Signaling Port)# [no] port &lt;1025..65535&gt;</code>	Enter the custom UDP port number for SIP traffic. The <code>no</code> command removes the custom UDP port number for SIP traffic.
<code>[no] alg &lt;h323   ftp&gt; [signal-port &lt;1025..65535&gt;   signal-extra-port &lt;1025..65535&gt;   transformation]</code>	<p>Turns on or configures the H.323 or FTP ALG.</p> <p>Use <code>signal-port</code> with a listening port number (1025 to 65535) if you are using H.323 on a TCP port other than 1720 or FTP on a TCP port other than 21.</p> <p>Use <code>signal-extra-port</code> with a listening port number (1025 to 65535) if you are also using H.323 or FTP on an additional TCP port number, enter it here.</p> <p>Use <code>transformation</code> to have the Zyxel Device modify IP addresses and port numbers embedded in the H.323 or FTP data payload. You do not need to use this if you have an H.323 or FTP device or server that will modify IP addresses and port numbers embedded in the H.323 or FTP data payload.</p> <p>The <code>no</code> command turns off the H.323 or FTP ALG or removes the settings that you specify.</p>
<code>show alg &lt;sip   h323   ftp&gt;</code>	Displays the specified ALG's configuration.

## 25.3 ALG Commands Example

The following example turns on pass through for SIP and turns it off for H.323.

```
Router# configure terminal
Router(config)# alg sip
Router(config)# no alg h323
```

# CHAPTER 26

## UPnP

### 26.1 UPnP and NAT-PMP Overview

The Zyxel Device supports both UPnP and NAT-PMP to permit networking devices to discover each other and connect seamlessly.

Universal Plug and Play (UPnP) is a distributed, open networking standard that uses TCP/IP for simple peer-to-peer network connectivity between devices. A UPnP device can dynamically join a network, obtain an IP address, convey its capabilities and learn about other devices on the network. In turn, a device can leave a network smoothly and automatically when it is no longer in use. A gateway that supports UPnP is called Internet Gateway Device (IGD). The standardized Device Control Protocol (DCP) is defined by the UPnP Forum for IGDs to configure port mapping automatically.

NAT Port Mapping Protocol (NAT-PMP), introduced by Apple and implemented in current Apple products, is used as an alternative NAT traversal solution to the UPnP IGD protocol. NAT-PMP runs over UDP port 5351. NAT-PMP is much simpler than UPnP IGD and mainly designed for small home networks. It allows a client behind a NAT router to retrieve the router's public IP address and port number and make them known to the peer device with which it wants to communicate. The client can automatically configure the NAT router to create a port mapping to allow the peer to contact it.

### 26.2 UPnP and NAT-PMP Commands

The following table lists the `ip upnp` commands. You must use the `configure terminal` command to enter the configuration mode before you can use these commands.

Table 105 ip upnp Commands

COMMAND	DESCRIPTION
<code>ip upnp</code>	Enters the <code>config-upnp</code> sub-command mode to configure the UPnP or NAT-PMP settings.
<code>[no] bypass-firewall activate</code>	Allows traffic from UPnP-enabled or NAT-PMP-enabled applications to bypass the firewall.  The <code>no</code> command has the firewall block all UPnP or NAT-PMP application packets (for example, MSN packets).
<code>link-sticking outgoing interface {interface_name   all}</code>	Specifies through which WAN interface(s) you want to send out traffic from UPnP-enabled or NAT-PMP-enabled applications.  If the WAN interface you specified loses its connection, the Zyxel Device attempts to use the other WAN interface. If the other WAN interface also does not work, the Zyxel Device drops outgoing packets from UPnP-enabled or NAT-PMP-enabled applications.
<code>[no] listen-interface interface_name</code>	Enables UPnP and/or NAT-PMP on an internal interface.  The <code>no</code> command disables UPnP and/or NAT-PMP on the interface.

Table 105 ip upnp Commands (continued)

COMMAND	DESCRIPTION
[no] nat-pmp activate	Enables NAT-PMP on the Zyxel Device. The no command disables NAT-PMP on the Zyxel Device.
[no] upnp-igd activate	Enables UPnP on the Zyxel Device. The no command disables UPnP on the Zyxel Device.
no ip upnp port-mapping port {<1..65535> type <tcp udp>   all}	Removes all or a specific port mapping rule.
show ip upnp listen-interface	Displays the name(s) of the internal interface(s) on which the Zyxel Device supports UPnP and/or NAT-PMP.
show ip upnp port-mapping	Displays the UPnP and/or NAT-PMP port mapping rules on the Zyxel Device.
show ip upnp status	Displays the UPnP and/or NAT-PMP configuration.

## 26.3 UPnP & NAT-PMP Commands Example

The following example turns on UPnP and NAT-PMP on the Zyxel Device and its two LAN interfaces. It also shows the UPnP and NAT-PMP settings.

```
Router# configure terminal
Router(config)# ip upnp
Router(config-upnp)# nat-pmp activate
Router(config-upnp)# upnp-igd activate
Router(config-upnp)# listen-interface lan1
Router(config-upnp)# listen-interface lan2
Router(config-upnp)# exit
Router(config)# show ip upnp status
upnp active: yes
nat-pmp active: yes
bypass-firewall active: no
link-sticking outgoing: all
Router(config)# show ip upnp listen-interface
interface
=====
lan1
lan2
Router(config)#
```



The following example displays the Zyxel Device's port mapping entries and removes the entry with the specified port number and protocol type.

```
Router# configure terminal
Router(config) # show ip upnp port-mapping
No: 0
  Remote Host: (null)
  Client Type: upnp
  External Port: 1122
  Protocol: tcp
  Internal Port: 1122
  Internal Client: 172.16.1.2
  Description: test1
No: 1
  Remote Host: (null)
  Client Type: upnp
  External Port: 5566
  Protocol: tcp
  Internal Port: 5566
  Internal Client: 172.16.1.2
  Description: test2
Router(config)# no ip upnp port-mapping port 5566 type tcp
Router(config)# show ip upnp port-mapping
No: 0
  Remote Host: (null)
  Client Type: upnp
  External Port: 1122
  Protocol: tcp
  Internal Port: 1122
  Internal Client: 172.16.1.2
  Description: test1
Router(config)#
```

# CHAPTER 27

## IP/MAC Binding

### 27.1 IP/MAC Binding Overview

IP address to MAC address binding helps ensure that only the intended devices get to use privileged IP addresses. The Zyxel Device uses DHCP to assign IP addresses and records to MAC address it assigned each IP address. The Zyxel Device then checks incoming connection attempts against this list. A user cannot manually assign another IP to his computer and use it to connect to the Zyxel Device.

Suppose you configure access privileges for IP address 192.168.1.27 and use static DHCP to assign it to Tim's computer's MAC address of 12:34:56:78:90:AB. IP/MAC binding drops traffic from any computer with another MAC address that tries to use IP address 192.168.1.27.

### 27.2 IP/MAC Binding Commands

The following table lists the `ip-mac-binding` commands. You must use the `configure terminal` command to enter the configuration mode before you can use these commands.

Table 106 ip-mac-binding Commands

COMMAND	DESCRIPTION
<code>[no] ip ip-mac-binding interface_name activate</code>	Turns on IP/MAC binding for the specified interface. The <code>no</code> command turns IP/MAC binding off for the specified interface.
<code>[no] ip ip-mac-binding interface_name log</code>	Turns on the IP/MAC binding logs for the specified interface. The <code>no</code> command turns IP/MAC binding logs off for the specified interface.
<code>ip ip-mac-binding exempt name start-ip end-ip</code>	Adds a named IP range as being exempt from IP/MAC binding.
<code>no ip ip-mac-binding exempt name</code>	Deletes the named IP range from the list of addresses that are exempt from IP/MAC binding.
<code>show ip ip-mac-binding interface_name</code>	Shows whether IP/MAC binding is enabled or disabled for the specified interface.
<code>show ip ip-mac-binding all</code>	Shows whether IP/MAC binding is enabled or disabled for all interfaces.
<code>show ip ip-mac-binding status interface_name</code>	Displays the current IP/MAC bindings for the specified interface.
<code>show ip ip-mac-binding status all</code>	Displays the current IP/MAC bindings for all interfaces.
<code>show ip ip-mac-binding exempt</code>	Shows the current IP/MAC binding exempt list.
<code>ip ip-mac-binding clear-drop-count interface_name</code>	Resets the packet drop counter for the specified interface.

## 27.3 IP/MAC Binding Commands Example

The following example enables IP/MAC binding on the LAN1 interface and displays the interface's IP/MAC binding status.

```
Router# configure terminal
Router(config)# ip ip-mac-binding lan1 activate
Router(config)# show ip ip-mac-binding lan1
Name: lan1
Status: Enable
Log: No
Binding Count: 0
Drop Count: 0
Router(config)#
```

# CHAPTER 28

## Layer 2 Isolation

### 28.1 Layer 2 Isolation Overview

Layer-2 isolation is used to prevent connected devices from communicating with each other in the Zyxel Device's local network(s), on which layer-2 isolation is enabled, except the devices in the white list.

Note: Layer-2 isolation does not check the wireless traffic.

In the following example, layer-2 isolation is enabled on the Zyxel Device's interface Vlan1. A printer, PC and AP are in the Vlan1. The IP address of network printer (C) is added to the white list. The connected AP then cannot communicate with the PC (D), but can access the network printer (C), server (B), wireless client (A) and the Internet.

**Figure 23** Layer-2 Isolation Application

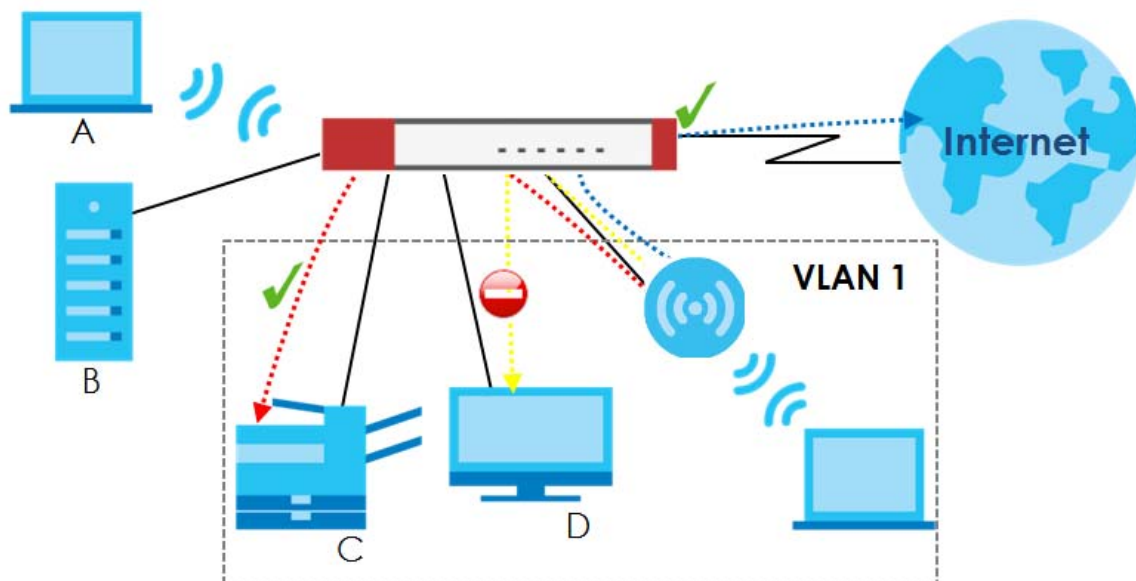

## 28.2 Layer 2 Isolation Commands

The following table lists the `l2-isolation` commands. You must use the `configure terminal` command to enter the configuration mode before you can use these commands.

Table 107 l2-isolation Commands

COMMAND	DESCRIPTION
<code>l2-isolation</code>	Enters the layer 2 isolation sub-command mode to enable Layer-2 isolation on the Zyxel Device and specific internal interface(s).
<code>[no] activate</code>	Turns on Layer-2 isolation on the Zyxel Device. The <code>no</code> command disables Layer-2 isolation on the Zyxel Device.
<code>[no] interface interface_name</code>	Turns on Layer-2 isolation on a specific internal interface. The <code>no</code> command disables Layer-2 isolation for the specified interface.
<code>white-list rule_number</code>	Enters the layer 2 isolation white list sub-command mode to set a new rule in the white list. See <a href="#">Table 108 on page 213</a> for the sub-commands.  <i>rule_number</i> : 1 - N, where N depends on the Zyxel Device model.
<code>white-list activate</code>	Turns on the white list on the Zyxel Device.  IP addresses that are not listed in the white list are blocked from communicating with other devices in the layer-2-isolation-enabled internal interface(s) except for broadcast packets.
<code>white-list append</code>	Enters the layer 2 isolation white list sub-command mode to add a rule to the end of the white list. See <a href="#">Table 108 on page 213</a> for the sub-commands.
<code>white-list flush</code>	Removes all rules in the white list.
<code>white-list no activate</code>	Turns the white list off.
<code>no l2-isolation activate</code>	Disables Layer-2 isolation on the Zyxel Device.
<code>no l2-isolation white-list rule_number</code>	Disables the specified rule in the white list.  <i>rule_number</i> : 1 - N, where N depends on the Zyxel Device model.
<code>no l2-isolation white-list activate</code>	Turns on the white list on the Zyxel Device.
<code>show l2-isolation</code>	Displays whether Layer-2 isolation is enabled on an interface.
<code>show l2-isolation activation</code>	Displays whether Layer-2 isolation is enabled on the Zyxel Device.
<code>show l2-isolation white-list [rule_number]</code>	Displays all or a specified white list rule settings.  <i>rule_number</i> : 1 - N, where N depends on the Zyxel Device model.
<code>show l2-isolation white-list activation</code>	Displays whether the white list is enabled.

### 28.2.1 Layer 2 Isolation White List Sub-Commands

The following table describes the sub-commands for `l2-isolation white-list` commands.

Table 108 l2-isolation white-list Sub-commands

COMMAND	DESCRIPTION
<code>[no] activate</code>	Enables the rule. The <code>no</code> command disables the rule.

Table 108 l2-isolation white-list Sub-commands (continued)

COMMAND	DESCRIPTION
[no] description <i>description</i>	Sets a descriptive name (up to 60 printable ASCII characters) for a rule. The no command removes the descriptive name from the rule.
[no] ip-address <i>ip</i>	Sets an IPv4 address associated with this rule. The no command removes the IP address.  This is the IP address of device that can be accessed by the devices connected to an internal interface on which layer-2 isolation is enabled.

## 28.3 Layer 2 Isolation Commands Example

The following example enables Layer-2 isolation on the Zyxel Device and interface lan2. It also creates a rule in the white list to allow access to the device with IP address 172.17.0.66. It then displays the Layer-2 isolation settings.

```
Router# configure terminal
Router(config)# l2-isolation
Router(l2-isolation)# activate
Router(l2-isolation)# interface lan2
Router(l2-isolation)# white-list 1
Router(white-list)# activate
Router(white-list)# description PC
Router(white-list)# ip-address 172.17.0.66
Router(white-list)# exit
Router(config)# show l2-isolation
interface
=====
lan2
Router(config)# show l2-isolation activation
Layer2 Isolation Status: yes
Router(config)# show l2-isolation white-list
layer2 isolation white list rule: 1
  active: yes
  ip address: 172.17.0.66
  description: PC
Router(config)#
```

# CHAPTER 29

## Secure Policy

This chapter introduces the Zyxel Device's secure policies and shows you how to configure them.

Note: In the guide Secure Policy commands may also be referred to as Firewall in general descriptions.

### 29.1 Secure Policy Overview

A secure policy is a template of security settings that can be applied to specific traffic at specific times. The policy can be applied:

- to a specific direction of travel of packets (from / to)
- to a specific source and destination address objects
- to a specific type of traffic (services)
- to a specific user or group of users
- at a specific schedule

The policy can be configured:

- to allow or deny traffic that matches the criteria above
- send a log or alert for traffic that matches the criteria above
- to apply the actions configured in the UTM profiles (such as application patrol, content filter, IDP, anti-virus, anti-spam) to traffic that matches the criteria above

Note: Secure policies can be applied to both IPv4 and IPv6 traffic

The secure policies can also limit the number of user sessions.

The following example shows the Zyxel Device's default security policies behavior for a specific direction of travel of packets. WAN to LAN traffic and how stateful inspection works. A LAN user can initiate a Telnet session from within the LAN zone and the Zyxel Device allows the response. However, the Zyxel Device blocks incoming Telnet traffic initiated from the WAN zone and destined for the LAN zone.

**Figure 24** Default Directional Policy Example

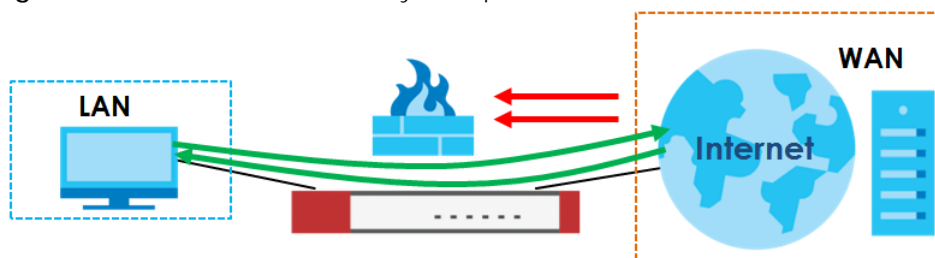

## 29.2 Secure Policy Commands

The following table identifies the values required for many of these commands. Other input values are discussed with the corresponding commands.

Table 109 Input Values for Secure Policy Commands

LABEL	DESCRIPTION
<i>address_object</i>	The name of the IP address (or address group) object. You may use 1-31 alphanumeric characters, underscores(_), or dashes (-), but the first character cannot be a number. This value is case-sensitive.
<i>address6_object</i>	The name of the IPv6 address (or address group) object. You may use 1-31 alphanumeric characters, underscores(_), or dashes (-), but the first character cannot be a number. This value is case-sensitive.
<i>user_name</i>	The name of a user (group). You may use 1-31 alphanumeric characters, underscores(_), or dashes (-), but the first character cannot be a number. This value is case-sensitive.
<i>zone_object</i>	The name of the zone. For some Zyxel Device models, use up to 31 characters (a-zA-Z0-9_). The name cannot start with a number. This value is case-sensitive.  For other Zyxel Device models, use pre-defined zone names like DMZ, LAN1, SSL VPN, IPSec VPN, OPT, and WAN.
<i>rule_number</i>	The priority number of a secure policy. 1 - <i>X</i> where <i>X</i> is the highest number of rules the Zyxel Device model supports. See the Zyxel Device's User's Guide for details.
<i>schedule_object</i>	The name of the schedule. You may use 1-31 alphanumeric characters, underscores(_), or dashes (-), but the first character cannot be a number. This value is case-sensitive.
<i>service_name</i>	The name of the service (group). You may use 1-31 alphanumeric characters, underscores(_), or dashes (-), but the first character cannot be a number. This value is case-sensitive.

The following table describes the commands available for the secure policy. You must use the `configure terminal` command to enter the configuration mode before you can use the configuration commands. Commands that do not have IPv6 specified in the description are for IPv4.

Table 110 Command Summary: Secure Policy

COMMAND	DESCRIPTION
<code>secure-policy activate</code>	Enables Secure Policy on the Zyxel Device to perform access control.
<code>secure-policy backup activate</code>	Backs up all secure policies configured on the Zyxel Device when you make any configuration changes (insert/modify/delete/append).  Type <code>dir /conf/</code> to see all configuration files on the Zyxel Device. These files are also visible in <b>Maintenance &gt; File Manager &gt; Configuration File</b> in the web configurator. Filenames beginning with <code>autoback</code> are automatic configuration files created when new firmware is uploaded. <code>backup-yyyymm-dd-hh-mm-ss.conf</code> is the name of the automatic backup when a secure policy is added or changed. Type <code>appy config-file-name</code> to restore secure policy configuration to what it was before that change.
<code>show secure-policy _check-exposed-srv</code>	Displays if only specified IP addresses or Fully Qualified Domain Names (FQDNs) are allowed to access the Zyxel Device remotely.  Displays if only SSL VPN clients from specified regions are allowed to access the Zyxel Device.
<code>show secure-policy backup status</code>	Displays if backing up of secure policies when changes are done is configured on the Zyxel Device.



Table 110 Command Summary: Secure Policy (continued)

COMMAND	DESCRIPTION
<code>show secure-policy filter from zone_object to zone_object srcip &lt;ip-address&gt; dstip &lt;ip&gt; service {any   tcp   udp   icmp   gre   esp   user-defined} port-number user user_name sch schedule_object</code>	Applies IPv4 search filters to find specific IPv4 security policies based on direction, application, user, source, destination and/or schedule.
<code>[no] secure-policy asymmetrical-route activate</code>	Allows or disallows asymmetrical route topology.
<code>secure-policy rule_number</code>	Enters the secure policy sub-command mode to set a firewall rule. See <a href="#">Table 111 on page 219</a> for the sub-commands.
<code>secure-policy zone_object {zone_object ZyWALL} rule_number</code>	Enters the secure policy sub-command mode to set a direction specific through-ZyWALL rule or to-ZyWALL rule. See <a href="#">Table 111 on page 219</a> for the sub-commands.
<code>secure-policy zone_object {zone_object ZyWALL} append</code>	Enters the secure policy sub-command mode to add a direction specific through-ZyWALL rule or to-ZyWALL rule to the end of the global rule list. See <a href="#">Table 111 on page 219</a> for the sub-commands.
<code>secure-policy zone_object {zone_object ZyWALL} delete &lt;1..5000&gt;</code>	Removes a direction specific through-ZyWALL rule or to-ZyWALL rule.  <1..5000>: the index number in a direction specific secure policy rule list.
<code>secure-policy zone_object {zone_object ZyWALL} flush</code>	Removes all direction specific through-ZyWALL rule or to-ZyWALL rules.
<code>secure-policy zone_object {zone_object ZyWALL} insert rule_number</code>	Enters the secure policy sub-command mode to add a direction specific through-ZyWALL rule or to-ZyWALL rule before the specified rule number. See <a href="#">Table 111 on page 219</a> for the sub-commands.
<code>secure-policy zone_object {zone_object ZyWALL} move rule_number to rule_number</code>	Moves a direction specific through-ZyWALL rule or to-ZyWALL rule to the number that you specified.
<code>[no] secure-policy activate</code>	Enables the secure policy on the Zyxel Device. The no command disables the secure policy.
<code>secure-policy append</code>	Enters the secure policy sub-command mode to add a global secure policy rule to the end of the global rule list. See <a href="#">Table 111 on page 219</a> for the sub-commands.
<code>secure-policy default-rule action {allow   deny   reject} { no log   log [alert] }</code>	Sets how the secure policy handles packets that do not match any other secure policy rule.
<code>secure-policy delete rule_number</code>	Removes a secure policy rule.
<code>secure-policy flush</code>	Removes all secure policy rules.
<code>secure-policy insert rule_number</code>	Enters the secure policy sub-command mode to add a secure policy rule before the specified rule number. See <a href="#">Table 111 on page 219</a> for the sub-commands.
<code>secure-policy move rule_number to rule_number</code>	Moves a secure policy rule to the number that you specified.
<code>firewall icsa {icmp-destroy-session} {enable   disable}</code>	During ICSA certification a connection automatically terminates immediately once ICMP unreachable or ICMP TTL expired is received. Use this command to turn off this behavior.

Table 110 Command Summary: Secure Policy (continued)

COMMAND	DESCRIPTION
<code>show firewall icsa status</code>	Displays if a ICSA certification connection is automatically terminated immediately once ICMP unreachable or ICMP TTL expired is received.
<code>show secure-policy</code>	Displays all Secure Policy settings.
<code>show secure-policy rule_number</code>	Displays a secure policy rule's settings.
<code>show secure-policy zone_object {zone_object ZyWALL}</code>	Displays all secure policy rules settings for the specified packet direction.
<code>show secure-policy zone_object {zone_object ZyWALL} rule_number</code>	Displays a specified secure policy rule's settings for the specified packet direction.
<code>show secure-policy status</code>	Displays whether or not the secure policy is active, whether or not asymmetrical route topology is allowed, and the default secure policy rule's configuration.
<code>show secure-policy block_rules</code>	Displays all the secure policy rules that deny access.
<code>show secure-policy any ZyWALL</code>	Shows all the to-Zyxel Device secure policy rules.
<code>show secure-policy6 filter from zone_object to zone_object srcip6 &lt;ip-address&gt; dstip6 &lt;ip&gt; service {any   tcp   udp   icmp   gre   esp   user-defined} port-number user user_name sch schedule_object</code>	Applies IPv6 search filters to find specific IPv6 (if enabled) security policies based on direction, application, user, source, destination and/or schedule.
<code>secure-policy6 rule_number</code>	Enters the IPv6 secure policy sub-command mode to set a secure policy rule. See <a href="#">Table 111 on page 219</a> for the sub-commands.
<code>secure-policy6 zone_object {zone_object ZyWALL} rule_number</code>	Enters the IPv6 firewall sub-command mode to set a direction specific through-ZyWALL rule or to-ZyWALL rule. See <a href="#">Table 111 on page 219</a> for the sub-commands.
<code>secure-policy6 zone_object {zone_object ZyWALL} append</code>	Enters the IPv6 secure policy sub-command mode to add a direction specific through-ZyWALL rule or to-ZyWALL rule to the end of the global rule list. See <a href="#">Table 111 on page 219</a> for the sub-commands.
<code>secure-policy6 zone_object {zone_object ZyWALL} delete &lt;1..5000&gt;</code>	Removes a direction specific IPv6 through-ZyWALL rule or to-ZyWALL rule.  <1..5000>: the index number in a direction specific firewall rule list.
<code>secure-policy6 zone_object {zone_object ZyWALL} flush</code>	Removes all direction specific IPv6 through-ZyWALL rule or to-ZyWALL rules.
<code>secure-policy6 zone_object {zone_object ZyWALL} insert rule_number</code>	Enters the IPv6 secure policy sub-command mode to add a direction specific through-ZyWALL rule or to-ZyWALL rule before the specified rule number. See <a href="#">Table 111 on page 219</a> for the sub-commands.
<code>secure-policy6 zone_object {zone_object ZyWALL} move rule_number to rule_number</code>	Moves a direction specific IPv6 through-ZyWALL rule or to-ZyWALL rule to the number that you specified.
<code>[no] secure-policy6 activate</code>	Enables the IPv6 secure policy on the Zyxel Device. The <code>no</code> command disables the IPv6 firewall.
<code>secure-policy6 append</code>	Enters the IPv6 secure policy sub-command mode to add a global firewall rule to the end of the global rule list. See <a href="#">Table 111 on page 219</a> for the sub-commands.

Table 110 Command Summary: Secure Policy (continued)

COMMAND	DESCRIPTION
<code>secure-policy6 default-rule action {allow   deny   reject} { no log   log [alert] }</code>	Sets how the IPv6 secure policy handles packets that do not match any other secure policy rule.
<code>secure-policy6 delete rule_number</code>	Removes a IPv6 secure policy rule.
<code>secure-policy6 flush</code>	Removes all IPv6 secure policy rules.
<code>secure-policy6 insert rule_number</code>	Enters the IPv6 secure policy sub-command mode to add a secure policy rule before the specified rule number. See <a href="#">Table 111 on page 219</a> for the sub-commands.
<code>secure-policy6 move rule_number to rule_number</code>	Moves a IPv6 secure policy rule to the number that you specified.
<code>show secure-policy6</code>	Displays all IPv6 secure policy settings.
<code>show secure-policy6 rule_number</code>	Displays a IPv6 secure policy rule's settings.
<code>show secure-policy6 zone_object {zone_object ZyWALL}</code>	Displays all IPv6 secure policy rules settings for the specified packet direction.
<code>show secure-policy6 zone_object {zone_object ZyWALL} rule_number</code>	Displays a specified IPv6 secure policy rule's settings for the specified packet direction.
<code>show secure-policy6 status</code>	Displays whether or not the IPv6 secure policy is active, whether or not IPv6 asymmetrical route topology is allowed, and the default IPv6 secure policy rule's configuration.
<code>show secure-policy6 block_rules</code>	Displays all the IPv6 secure policy rules that deny access.
<code>show secure-policy6 any ZyWALL</code>	Shows all the IPv6 to-Zyxel Device secure policy rules.
<code>[no] secure-policy6 asymmetrical- route activate</code>	Allows or disallows asymmetrical route topology for IPv6 traffic.
<code>session-status-update reply-time &lt;5..300&gt;</code>	Set how many seconds the Zyxel Device will allow a session to remain idle (without traffic) before closing it.
<code>session-status-update alg {active inactive}</code>	Enables or Disables ALG session updates
<code>show session-status-update reply- time</code>	Displays idle session timeout

## 29.2.1 Secure Policy Sub-Commands

The following table describes the sub-commands for several `secure-policy` and `secure-policy6` commands.

Table 111 firewall Sub-commands

COMMAND	DESCRIPTION
<code>action {allow deny reject}</code>	Sets the action the Zyxel Device takes when packets match this rule.
<code>[no] activate</code>	Enables a secure policy rule. The <code>no</code> command disables the rule.

Table 111 firewall Sub-commands (continued)

COMMAND	DESCRIPTION
[no] ctmatch {dnat   snat}	Use <code>dnat</code> to block packets sent from a computer on the Zyxel Device's WAN network from being forwarded to an internal network according to a virtual server rule.  Use <code>snat</code> to block packets sent from a computer on the Zyxel Device's internal network from being forwarded to the WAN network according to a 1:1 NAT or Many 1:1 NAT rule.  The <code>no</code> command forwards the matched packets.  Subcommands cannot be used with <code>secure-policy6</code> .
[no] description <i>description</i>	Sets a descriptive name (up to 60 printable ASCII characters) for a secure policy rule. The <code>no</code> command removes the descriptive name from the rule.
[no] destinationip <i>address_object</i>	Sets the destination IP address. The <code>no</code> command resets the destination IP address(es) to the default ( <code>any</code> ). <code>any</code> means all IP addresses.
[no] destinationip6 <i>address_object</i>	Sets the destination IPv6 address. The <code>no</code> command resets the destination IP address(es) to the default ( <code>any</code> ). <code>any</code> means all IP addresses.
[no] from <i>zone_object</i>	Sets the zone on which the packets are received. The <code>no</code> command removes the zone on which the packets are received and resets it to the default ( <code>any</code> ) meaning all interfaces or VPN tunnels.
[no] log [alert]	Sets the Zyxel Device to create a log (and optionally an alert) when packets match this rule. The <code>no</code> command sets the Zyxel Device not to create a log or alert when packets match this rule.
[no] schedule <i>schedule_object</i>	Sets the schedule that the rule uses. The <code>no</code> command removes the schedule settings from the rule.
[no] service <i>service_name</i>	Sets the service to which the rule applies. The <code>no</code> command resets the service settings to the default ( <code>any</code> ). <code>any</code> means all services.
[no] sourceip <i>address_object</i>	Sets the source IP address(es). The <code>no</code> command resets the source IP address(es) to the default ( <code>any</code> ). <code>any</code> means all IP addresses.
[no] sourceip6 <i>address_object</i>	Sets the source IP address(es). The <code>no</code> command resets the source IP address(es) to the default ( <code>any</code> ). <code>any</code> means all IP addresses.
[no] sourceport {tcp udp} {eq <1..65535> range <1..65535> <1..65535>}	Sets the source port for a secure policy rule. The <code>no</code> command removes the source port from the rule.
[no] to { <i>zone_object</i>  ZyWALL}	Sets the zone to which the packets are sent. The <code>no</code> command removes the zone to which the packets are sent and resets it to the default ( <code>any</code> ). <code>any</code> means all interfaces or VPN tunnels.
[no] user <i>user_name</i>	Sets a user-aware secure policy rule. The rule is activated only when the specified user logs into the system. The <code>no</code> command resets the user name to the default ( <code>any</code> ). <code>any</code> means all users.  Subcommands cannot be used with <code>secure-policy6</code> .
secure-policy < <i>profile name</i> >	Creates a secure policy rule. You may use 1-31 alphanumeric characters, underscores ( <code>_</code> ), or dashes ( <code>-</code> ), but the first character cannot be a number. This value is case-sensitive.

Table 111 firewall Sub-commands (continued)

COMMAND	DESCRIPTION
[no] cf-profile <profile name> { [no log]   [log by-profile] } { activate   deactivate }	Applies the (already-created) named anti- x profile to traffic that matches the secure-policy rule. Log by-profile generates a log for all traffic that matches criteria in the anti- x profile. no log does turns off logging and overrides the anti- x profile log setting. The no command does not apply the named anti- x profile to traffic that matches the secure-policy rule.
[no] as-profile <profile name> { [no log]   [log by-profile] } { activate   deactivate }	Applies the (already-created) named anti- x profile to traffic that matches the secure-policy rule. Log by-profile generates a log for all traffic that matches criteria in the anti- x profile. no log does turns off logging and overrides the anti- x profile log setting. The no command does not apply the named anti- x profile to traffic that matches the secure-policy rule.
[no] av-profile <profile name>{ [no log]   [log by-profile] } { activate   deactivate }	Applies the (already-created) named anti- x profile to traffic that matches the secure-policy rule. Log by-profile generates a log for all traffic that matches criteria in the anti- x profile. no log does turns off logging and overrides the anti- x profile log setting. The no command does not apply the named anti- x profile to traffic that matches the secure-policy rule.
[no] idp-profile <profile name> { [no log]   [log by-profile] } { activate   deactivate }	Applies the (already-created) named anti- x profile to traffic that matches the secure-policy rule. Log by-profile generates a log for all traffic that matches criteria in the anti- x profile. no log does turns off logging and overrides the anti- x profile log setting. The no command does not apply the named anti- x profile to traffic that matches the secure-policy rule.
[no] ssl-profile <profile name> { [no log]   [log by-profile] } { activate   deactivate }	Applies the (already-created) named anti- x profile to traffic that matches the secure-policy rule. Log by-profile generates a log for all traffic that matches criteria in the anti- x profile. no log does turns off logging and overrides the anti- x profile log setting. The no command does not apply the named anti- x profile to traffic that matches the secure-policy rule.
[no] app-profile <profile name> { [no log]   [log by-profile] } { activate   deactivate }	Applies the (already-created) named anti- x profile to traffic that matches the secure-policy rule. Log by-profile generates a log for all traffic that matches criteria in the anti- x profile. no log does turns off logging and overrides the anti- x profile log setting. The no command does not apply the named anti- x profile to traffic that matches the secure-policy rule.

## 29.2.2 Security Services Multiple Profiles

By default, security services such as anti-malware, URL threat filter, and DNS filter, support multiple profiles in the CLI but only a single profile in the Web Configurator. To enable multiple profiles in the Web Configurator, you need to change the Zyxel Device's display mode.

Table 112 Secure Policy Style Commands

COMMAND	DESCRIPTION
<code>secure-policy-style {general / advance}</code>	<p>Enables or disables multiple profiles for the following security services:</p> <ul style="list-style-type: none"> <li>• Anti-virus</li> <li>• DNS Filter</li> <li>• Threat website</li> <li>• IDP (Intrusion Detection and Prevention)</li> <li>• Anti-spam</li> </ul> <p><i>general</i>: Multiple profiles are disabled for the listed security services. This is the default option. When the Zyxel Device is set to this mode, a profile named <i>default_profile</i> maps to the settings in the Web Configurator UI.</p> <p><i>advance</i>: Multiple profiles are enabled for the listed security services.</p> <p>Note: To change the mode from advance to general, ensure that the inspect policy of each of the listed security services is set to <b>all-traffic</b>.</p>
<code>secure-policy-style advance all-inspect-by-policy</code>	<p>Enables multiple profiles for the following security services, and also sets all security services to inspect by policy.</p> <ul style="list-style-type: none"> <li>• Anti-virus</li> <li>• URL Threat Filter</li> <li>• IDP (Intrusion Detection and Prevention)</li> <li>• Anti-spam</li> </ul> <p>Inspect by policy means a security service inspects traffic only when its profile is bound to a security policy.</p> <p>For information on binding a security service profile to a security policy, see <a href="#">Section 29.2.1 on page 219</a>.</p>
<code>show secure-policy-style status</code>	Displays the current secure policy style setting (general or advanced).
<code>show security-service inspect status</code>	Displays the inspect policy setting (all traffic or by policy) for each security service.

### 29.2.3 Secure Policy Command Examples

These are IPv4 secure policy configuration examples. The IPv6 secure policy commands are similar.

The following example shows you how to add an IPv4 secure policy rule to allow a MyService connection from the WAN zone to the IP addresses Dest\_1 in the LAN zone.

- Enter configuration command mode.
- Create an IP address object.
- Create a service object.
- Enter the secure policy sub-command mode to add a secure policy rule.
- Set the direction of travel of packets to which the rule applies.
- Set the destination IP address(es).
- Set the service to which this rule applies.

- Set the action the Zyxel Device is to take on packets which match this rule.

```
Router# configure terminal
Router(config)# service-object MyService tcp eq 1234
Router(config)# address-object Dest_1 10.0.0.10-10.0.0.15
Router(config)# secure-policy insert 3
Router(secure-policy)# from WAN
Router(v)# to LAN
Router(secure-policy)# destinationip Dest_1
Router(secure-policy)# service MyService
Router(secure-policy)# action allow
```

The following command displays the default IPv4 secure policy rule that applies to the WAN to Zyxel Device packet direction. The secure policy rule number is in the rule's priority number in the global rule list.

```
Router(config)# show secure-policy WAN ZyWALL

secure-policy rule: 11
  name: WAN_to_Device
  description:
  user: any, schedule: none
  from: WAN, to: ZyWALL
  source IP: any, source port: any
  destination IP: any, service: Default_Allow_WAN_To_ZyWALL
  log: no, action: allow, status: yes
  connection match: no
  content-filter profile: none
    enable: no, log: by-profile
  anti-spam      profile: none
    enable: no, log: by-profile
  anti-virus     profile: none
    enable: no, log: by-profile
  idp            profile: none
    enable: no, log: by-profile
  ssl-inspection profile: none
    enable: no, log: by-profile
  app-patrol     profile: none
    enable: no, log: by-profile
```

The following command displays the default IPv6 firewall rule that applies to the WAN to Zyxel Device packet direction. The firewall rule number is in the rule's priority number in the global rule list.

```
Router(config)# show secure-policy6 WAN ZyWALL

secure-policy rule: 1
  name: Device_Default_Allow_Service
  description:
  user: any, schedule: none
  from: any, to: ZyWALL
  source IP: any, source port: any
  destination IP: any, service: Default_Allow_v6_any_to_ZyWALL
  log: no, action: allow, status: yes
  content-filter profile: none
    enable: no, log: by-profile
  anti-spam profile: none
    enable: no, log: by-profile
  anti-virus profile: none
    enable: no, log: by-profile
  idp profile: none
    enable: no, log: by-profile
  ssl-inspection profile: none
    enable: no, log: by-profile
  app-patrol profile: none
    enable: no, log: by-profile
secure-policy rule: 11
  name: WAN_to_Device
  description:
  user: any, schedule: none
  from: WAN, to: ZyWALL
  source IP: any, source port: any
  destination IP: any, service: Default_Allow_v6_WAN_To_ZyWALL
  log: no, action: allow, status: yes
  content-filter profile: none
    enable: no, log: by-profile
  anti-spam profile: none
    enable: no, log: by-profile
  anti-virus profile: none
    enable: no, log: by-profile
  idp profile: none
    enable: no, log: by-profile
  ssl-inspection profile: none
    enable: no, log: by-profile
  app-patrol profile: none
    enable: no, log: by-profile
```

The following commands activate secure-policy backup, displays its status and then shows where to find the configuration files. Filenames beginning with autoback are automatic configuration files created when new firmware is uploaded. `backup-2017-12-13-13-34-49.conf` is the name of the



automatic backup when a secure policy was added or changed. Type `apply backup-2017-12-13-13-34-49.conf` to restore secure policy configuration to what it was before that change.

```
Router(config)# secure-policy backup activate
Router(config)# show secure-policy backup status
secure-policy backup status: yes
Router(config)# dir /conf/
File Name                               Size      Modified Time
=====
system-default.conf                     70098    2017-11-03 18:02:19
startup-config.conf                     76090    2017-12-13 13:34:49
lastgood.conf                           74763    2017-11-23 16:24:54
startup-config-bad.conf                 31999    2017-11-03 18:52:14
411AAPH0Preb1-r58726-2015-04-14-06-03-07.conf 22733    2015-04-14 14:03:07
autobackup-0.00.conf                   27782    2016-12-29 10:51:50
420AAPH0b4s2-2016-12-29-02-46-53.conf    27782    2016-12-29 10:46:53
425AAPH0b2-2017-05-22-06-28-12.conf     28815    2017-05-22 14:28:12
autobackup-4.25.conf                   28815    2017-05-22 14:31:16
430AAPH0b1s1-2017-07-20-08-44-45.conf    29538    2017-07-20 16:44:45
autobackup-4.30.conf                   31999    2017-11-03 18:04:22
430AAPH0b2-2017-08-22-06-09-32.conf    30484    2017-08-22 14:09:32
430AAPH0b3-2017-11-03-10-01-27.conf    31999    2017-11-03 18:01:27
backup-2017-12-13-13-34-49.conf        75733    2017-12-13 13:34:49
```

The following command displays `Fail` if HTTP, HTTPS and SSL traffic can access to your Zyxel Device from any IPv4 source on the WAN.

The following command displays `OK` if HTTP, HTTPS and SSL traffic can access to your Zyxel Device only from specified IPv4 sources on the WAN.

```
Router# show secure-policy _check-exposed-srv
HTTPS-HTTP: Fail
SSLVPN: Fail
```

## Accessing the Zyxel Device from the WAN

This is an example of configuring security policy settings to allow access to the Zyxel Device from the WAN without deactivating the security policies.

- 1 Check the Security Policy status. Make sure the Zyxel Device Security Policy is activated to keep your network safe.

```
Router# show secure-policy status
secure-policy status: yes
secure-policy asymmetrical route status: no
secure-policy default rule: deny, log
secure-policy tcp flag detect: yes
```

- 2 Enter the `Default-Allow-WAN-To-ZyWALL` service group sub-command mode.

```
Router(config)# object-group service Default_Allow_WAN_To_ZyWALL
Router(group-service)#
;          description      no          service-object
<cr>      exit              object-group |
```

- 3 Add **HTTP**, **HTTPS**, **TELNET** and **SSH** to the service group member list. Exit sub-command mode. Exit configuration mode

```
Router(group-service)# service-object HTTP
Router(group-service)# service-object HTTPS
Router(group-service)# service-object TELNET
Router(group-service)# object-group SSH
Router(group-service)# exit
Router(config)# exit
```

- 4 Check the Zyxel Device DHCP-assigned IP address for the WAN. Use the IP address to access the Zyxel Device from the WAN.

```
Router# show interface all
No. Name          Status          IP Address      Mask            IP Assignment
=====
1   sfp             Down            0.0.0.0         0.0.0.0         Static
2   wan             100M/Full      XXX.XX.XX.XX    255.255.252.0   DHCP client
3   lan1           Down            192.168.1.1    255.255.255.0   Static
4   lan2           Down            192.168.2.1    255.255.255.0   Static
5   dmz            Down            192.168.3.1    255.255.255.0   Static
6   opt            Down            0.0.0.0         0.0.0.0         Static
```

## 29.3 Session Limit Commands

The following table identifies the values required for many of these commands. Other input values are discussed with the corresponding commands.

Table 113 Input Values for General Session Limit Commands

LABEL	DESCRIPTION
<i>rule_number</i>	The priority number of a session limit rule, 1 - 1000.
<i>address_object</i>	The name of the IP address (group) object. You may use 1-31 alphanumeric characters, underscores (_), or dashes (-), but the first character cannot be a number. This value is case-sensitive.
<i>address6_object</i>	The name of the IPv6 address (group) object. You may use 1-31 alphanumeric characters, underscores(_), or dashes (-), but the first character cannot be a number. This value is case-sensitive.
<i>user_name</i>	The name of a user (group). You may use 1-31 alphanumeric characters, underscores (_), or dashes (-), but the first character cannot be a number. This value is case-sensitive.

The following table describes the session-limit commands. You must use the `configure terminal` command to enter the configuration mode before you can use these commands.

Table 114 Command Summary: Session Limit

COMMAND	DESCRIPTION
[no] session-limit activate	Turns the session-limit feature on or off.
session-limit limit <0..8192>	Sets the default number of concurrent NAT/firewall sessions per host.
session-limit rule_number	Enters the session-limit sub-command mode to set a session-limit rule.
[no] activate	Enables the session-limit rule. The <code>no</code> command disables the session limit rule.
[no] address address_object	Sets the source IP address. The <code>no</code> command sets this to <code>any</code> , which means all IP addresses.
[no] description description	Sets a descriptive name (up to 64 printable ASCII characters) for a session-limit rule. The <code>no</code> command removes the descriptive name from the rule.
exit	Quits the sub-command mode.
[no] limit <0..8192>	Sets the limit for the number of concurrent NAT/firewall sessions this rule's users or addresses can have. 0 means any.
[no] user user_name	Sets a session-limit rule for the specified user. The <code>no</code> command resets the user name to the default ( <code>any</code> ). <code>any</code> means all users.
session-limit append	Enters the session-limit sub-command mode to add a session-limit rule to the end of the session-limit rule list.
session-limit delete rule_number	Removes a session-limit rule.
session-limit flush	Removes all session-limit rules.
session-limit insert rule_number	Enters the session-limit sub-command mode to add a session-limit rule before the specified rule number.
session-limit move rule_number to rule_number	Moves a session-limit to the number that you specified.
show session-limit	Shows the session-limit configuration.
show session-limit begin rule_number end rule_number	Shows the settings for a range of session-limit rules.
show session-limit rule_number	Shows the session-limit rule's settings.
show session-limit status	Shows the general session-limit settings.
[no] session-limit6 activate	Turns the IPv6 session-limit feature on or off.
session-limit6 limit <0..8192>	Sets the default number of concurrent NAT/firewall IPv6 sessions per host.
session-limit6 rule_number	Enters the IPv6 session-limit sub-command mode to set a session-limit rule.
[no] activate	Enables the IPv6 session-limit rule. The <code>no</code> command disables the session limit rule.
[no] address6 address6_object	Sets the IPv6 source IP address. The <code>no</code> command sets this to <code>any</code> , which means all IP addresses.

Table 114 Command Summary: Session Limit (continued)

COMMAND	DESCRIPTION
[no] <i>description</i> <i>description</i>	Sets a descriptive name (up to 64 printable ASCII characters) for a session-limit rule. The <code>no</code> command removes the descriptive name from the rule.
<code>exit</code>	Quits the sub-command mode.
[no] <code>limit &lt;0..8192&gt;</code>	Sets the limit for the number of concurrent NAT/firewall IPv6 sessions this rule's users or addresses can have. 0 means any.
[no] <code>user user_name</code>	Sets an IPv6 session-limit rule for the specified user. The <code>no</code> command resets the user name to the default ( <code>any</code> ). <code>any</code> means all users.
<code>session-limit6 append</code>	Enters the IPv6 session-limit sub-command mode to add a session-limit rule to the end of the session-limit rule list.
<code>session-limit6 delete</code> <i>rule_number</i>	Removes an IPv6 session-limit rule.
<code>session-limit6 flush</code>	Removes all IPv6 session-limit rules.
<code>session-limit6 insert</code> <i>rule_number</i>	Enters the IPv6 session-limit sub-command mode to add a session-limit rule before the specified rule number.
<code>session-limit6 move</code> <i>rule_number</i> to <i>rule_number</i>	Moves an IPv6 session-limit to the number that you specified.
<code>show session-limit6</code>	Shows the IPv6 session-limit configuration.
<code>show session-limit6 begin</code> <i>rule_number</i> end <i>rule_number</i>	Shows the settings for a range of IPv6 session-limit rules.
<code>show session-limit6</code> <i>rule_number</i>	Shows the IPv6 session-limit rule's settings.
<code>show session-limit6</code> <code>status</code>	Shows the general IPv6 session-limit settings.

## 29.4 ADP Commands Overview

Anomaly Detection and Prevention (ADP) protects against anomalies based on violations of protocol standards (RFCs – Requests for Comments) and abnormal flows such as port scans. This section introduces ADP, anomaly profiles and applying an ADP profile to a traffic direction.

### Traffic Anomalies

Traffic anomaly policies look for abnormal behavior or events such as port scanning, sweeping or network flooding. They operate at OSI layer-2 and layer-3. Traffic anomaly policies may be updated when you upload new firmware.

### Protocol Anomalies

Protocol anomalies are packets that do not comply with the relevant RFC (Request For Comments). Protocol anomaly detection includes:

- TCP Decoder
- UDP Decoder

- ICMP Decoder
- IP Decoder

Protocol anomaly policies may be updated when you upload new firmware.

### ADP Flood Detection Whitelist

Certain legitimate services, such as IP Sec with NAT traversal, might be erroneously treated as anomalous traffic by ADP flood detection. To prevent this, you can add the clients and/or services to the ADP Flood Detection Whitelist, which means they are not scanned for network flooding.

## 29.4.1 ADP Command Input Values

The following table identifies the values required for many of these commands. Other input values are discussed with the corresponding commands.

Table 115 Input Values for ADP Commands

LABEL	DESCRIPTION
<i>zone-rule</i>	The name of a zone. For some Zyxel Device models, use up to 31 characters (a-zA-Z0-9_-). The name cannot start with a number. This value is case-sensitive.  For other Zyxel Device models use pre-defined zone names like DMZ, LAN1, SSL VPN, WLAN, IPSec VPN, OPT, and WAN
<i>adp-profile</i>	The name of an ADP profile. It can consist of alphanumeric characters, the underscore, and the dash, and it is 1-31 characters long. Spaces are not allowed.

## 29.4.2 ADP Activation Commands

Use these commands to activate ADP and see status.

Table 116 ADP Activation Commands

LABEL	DESCRIPTION
<i>[no] idp anomaly activate</i>	Anomaly detection does not require registration. The <code>no</code> command disables the specified service.
<i>show idp anomaly activation</i>	Displays anomaly detection service status.

## 29.4.3 ADP Global Profile Commands

These commands apply to all ADP profiles on the Zyxel Device.

Table 117 ADP Global Profile Commands

LABEL	DESCRIPTION
<i>idp rename anomaly &lt;profile1&gt; &lt;profile2&gt;</i>	Rename an ADP anomaly profile originally named profile1 to profile2.
<i>no idp anomaly &lt;profile3&gt;</i>	Delete an ADP profile named profile3.
<i>show idp anomaly base profile</i>	Displays all anomaly detection base profiles.

Table 117 ADP Global Profile Commands (continued)

LABEL	DESCRIPTION
show idp anomaly profiles	Displays all ADP anomaly profiles.
show idp anomaly rules	Displays all ADP anomaly rules.

## 29.4.4 ADP Zone-to-Zone Rule Commands

These commands bind ADP profiles to traffic directions.

Table 118 ADP Zone-to-Zone Rule Commands

LABEL	DESCRIPTION
idp anomaly rule {append   <1..32>   insert <1..32>}	Creates an ADP anomaly rule and enters the sub-command mode.
bind profile	Binds the ADP anomaly profile to the entry's traffic direction.
no bind	Removes the ADP anomaly profile's binding.
from-zone zone_rule	Specifies the zone the traffic is coming from.
[no] activate	Turns on the ADP anomaly profile to traffic direction binding. The no command turns it off.
idp anomaly rule {delete <1..32>   move <1..32> to <1..32>}	Removes or moves an ADP anomaly profile to traffic direction entry.
no idp anomaly rule <1..32>	Removes an ADP anomaly profile to traffic direction entry.
show idp anomaly rules	Displays the ADP anomaly zone to zone rules.

## 29.4.5 ADP Add/Edit Profile Sub Commands

These commands create or edit ADP profiles.

Table 119 ADP Add/Edit Profile Commands

LABEL	DESCRIPTION
idp anomaly <i>adp-profile</i> [base {all   everything   none}]	Creates a new IDP anomaly profile called <i>adp-profile</i> . <i>adp-profile</i> uses the base profile you specify. Enters sub-command mode. All the following commands relate to the new profile. Use exit to quit sub-command mode.
description <i>description</i>	<i>description</i> : Use up to 60 printable ASCII characters
no description	The no command removes the descriptive name from the profile.
base {all   everything   none}	Use the base profile you specify. You cannot change the base profile after you specify it.
scan-detection sensitivity {low   medium   high}	Sets scan-detection sensitivity.
no scan-detection sensitivity	Clears scan-detection sensitivity. The default sensitivity is medium.
scan-detection block-period <1..3600>	Sets for how many seconds the ZyWALL / USG blocks all packets from being sent to the victim (destination) of a detected anomaly attack.

Table 119 ADP Add/Edit Profile Commands (continued)

LABEL	DESCRIPTION
[no] scan-detection {tcp-xxx} {activate   log [alert]   block}	Activates TCP scan detection options where {tcp-xxx} = {tcp-portscan   tcp-portscan-fin   tcp-portscan-syn tcp-portsweep }. Also sets TCP scan-detection logs or alerts and blocking. no deactivates TCP scan detection, its logs, alerts or blocking.
[no] scan-detection {udp-portscan} {activate   log [alert]   block}	Activates or deactivates UDP port scan . Also sets UDP scan-detection logs or alerts and blocking. no deactivates UDP scan detection, its logs, alerts or blocking.
flood-detection block-period <1..3600>	Sets for how many seconds the ZyWALL / USG blocks all packets from being sent to the victim (destination) of a detected anomaly attack.
[no] flood-detection {tcp-flood   udp-flood   icmp-flood   igmp-flood} {activate   log [alert]   block}	Activates or deactivates TCP, UDP,IGMP or ICMP flood detection. Also sets flood detection logs or alerts and blocking. no deactivates flood detection, its logs, alerts or blocking.
[no] tcp-decoder {tcp-xxx} activate	Activates or deactivates tcp decoder options where {tcp-xxx} = {bad-tcp-flag   bad-tcp-l4-size   tcp-fragment   tcp-land}
tcp-decoder {tcp-xxx} log [alert]	Sets tcp decoder log or alert options.
no tcp-decoder {tcp-xxx} log	Deactivates tcp decoder log or alert options.
[no] tcp-decoder {tcp-xxx} action {drop   reject-sender   reject-receiver   reject-both}}	Sets tcp decoder action.
[no] udp-decoder {bad-udp-l4-size   udp-land   udp-smurf} activate	Activates or deactivates udp decoder options.
udp-decoder {bad-udp-l4-size   udp-land   udp-smurf} log [alert]	Sets udp decoder log or alert options.
no udp-decoder {bad-udp-l4-size   udp-land   udp-smurf} log	Deactivates udp decoder log options.
udp-decoder {bad-udp-l4-size   udp-land   udp-smurf} action {drop   reject-sender   reject-receiver   reject-both}	Sets udp decoder action.
no udp-decoder {bad-udp-l4-size   udp-land   udp-smurf} action	Deactivates udp decoder actions.
[no] icmp-decoder {bad-icmp-l4-size   icmp-fragment   icmp-smurf} activate	Activates or deactivates icmp decoder options.

Table 119 ADP Add/Edit Profile Commands (continued)

LABEL	DESCRIPTION
icmp-decoder {bad-icmp-14-size   icmp-fragment   icmp-smurf} log [alert]	Sets icmp decoder log or alert options.
no icmp-decoder {bad-icmp-14-size icmp-fragment   icmp-smurf} log	Deactivates icmp decoder log options.
icmp-decoder {bad-icmp-14-size   icmp-fragment   icmp-smurf} action {drop   reject-sender   reject-receiver   reject-both}	Sets icmp decoder action.
no icmp-decoder {bad-icmp-14-size   icmp-fragment   icmp-smurf} action	Deactivates icmp decoder actions.
[no] ip-decoder {ip-spoof   ip-teardrop} activate	Activates or deactivates ip decoder options.
[no] ip-decoder {ip-spoof   ip-teardrop} log	Activates or deactivates ip decoder log options.
[no] ip-decoder {ip-spoof   ip-teardrop} action {drop   reject-sender   reject-receiver   reject-both}	Activates or deactivates ip decoder actions.
exit	Use exit to quit sub-command mode.
show idp anomaly profile scan-detection [all details]	Shows all scan-detection settings of the specified ADP profile.
show idp anomaly profile scan-detection {tcp-portscan   tcp-portscan-syn   tcp-portsweep   tcp-portscan-fin} details	Shows selected TCP scan-detection settings for the specified ADP profile.
show idp anomaly profile scan-detection {udp-portscan} details	Shows UDP scan-detection settings for the specified ADP profile.
show idp anomaly profile flood-detection [all details]	Shows all flood-detection settings for the specified ADP profile.
show idp anomaly profile flood-detection {tcp-flood   udp-flood   icmp-flood   icmp-flood} details	Shows flood-detection settings for the specified ADP profile.
show idp anomaly profile tcp-decoder all details	Shows tcp-decoder settings for the specified ADP profile.



Table 119 ADP Add/Edit Profile Commands (continued)

LABEL	DESCRIPTION
show idp anomaly profile tcp-decoder {bad-tcp-flag   bad-tcp-l4-size   tcp-land} details	Shows tcp-decoder settings for the specified ADP profile.
show idp anomaly profile udp-decoder all details	Shows udp-decoder settings for the specified ADP profile.
show idp anomaly profile udp-decoder {bad-udp-l4-size   udp-land   udp-smurf} details	Shows specific udp-decoder settings for the specified ADP profile.
show idp anomaly profile icmp-decoder all details	Shows all icmp-decoder settings for the specified ADP profile.
show idp anomaly profile icmp-decoder {bad-icmp-l4-size   icmp-smurf} details	Shows specific icmp-decoder settings for the specified ADP profile.
show idp anomaly adp-profile ip-decoder all details	Shows all ip-decoder settings for the specified ADP profile.
show idp anomaly adp-profile ip-decoder {ip-spoof   ip-teardrop} details	Shows specific ip-decoder settings for the specified ADP profile.

## 29.4.6 ADP Flood Detection Whitelist Commands

These commands apply add and remove clients/and or services from the ADP Flood Detection Whitelist.

Table 120 ADP Global Profile Commands

LABEL	DESCRIPTION
[no] idp anomaly white-list activate	Enables or disables the ADP Flood Detection Whitelist on the Zyxel Device.
idp anomaly white-list rule-name	Enters the ADP Flood Detection Whitelist subcommand mode for the specified whitelist entry. If the entry does not currently exist, the Zyxel Device creates it.
activate	Enables the ADP Flood Detection Whitelist entry.
deactivate	Disables the ADP Flood Detection Whitelist entry.
source {src-ipv4-obj   any} destination {dst-ipv4-obj   any} service {service_obj   any}	Sets the source IPv4 object, destination IPv4 object, and service object that the entry applies to. Use <i>any</i> to match any source, destination, or service.
no idp anomaly white-list rule-name	Deletes the specified ADP Flood Detection Whitelist entry.

Table 120 ADP Global Profile Commands (continued)

LABEL	DESCRIPTION
idp anomaly white-list rename <i>rule-name</i> <i>new-rule-name</i>	Renames the specified ADP Flood Detection Whitelist entry.
show idp anomaly white-list {all   <i>rule-name</i> }	Displays information about a single ADP Flood Detection Whitelist entry. All displays the whole whitelist.

# CHAPTER 30

## Cloud CNM

### 30.1 Cloud CNM Overview

The Cloud CNM product line consists of Cloud CNM SecuManager, Cloud CNM SecuDeployer and Cloud CNM SecuReporter. You need licenses to use them. You need the SecuManager license to get a **CNM ID** with which you can access the SecuManager server. It is independent from the Zyxel Devices. The SecuReporter license must be activated on each Zyxel Device. The SecuDeployer license must be activated on the SecuDeployer Zyxel Device server.

- Use **SecuManager** to enable and configure management of the Zyxel Device by a Central Network Management system.
- Use **SecuReporter** to enable SecuReporter logging on your Zyxel Device, see license status, type, expiration date and access a link to the SecuReporter web portal. The SecuReporter web portal collects and analyzes logs from your Zyxel Device in order to identify anomalies, alert on potential internal / external threats, and report on network usage.
- Use **SecuDeployer** to enable SecuDeployer which allows a Zyxel Device SecuDeployer server to manage and apply profile template settings to remote Zyxel Device clients. Provisioning can include the settings of one to multiple LAN/DMZ interfaces, Hub & Spoke IPSec tunnels, and/or static route settings for VTI IPSec VPNs.

Note: SecuManager and SecuDeployer cannot both be enabled on a Zyxel Device at the same time.

### 30.2 Cloud CNM SecuManager

Cloud CNM SecuManager is a Virtual Machine-based (VM) management system that uses the TR-069 protocol to encapsulate commands to ZyWALL/USG devices for management and monitoring; these devices must have firmware that supports the TR-069 protocol.

Cloud CNM SecuManager features include:

- Batch import of managed devices at one time using one CSV file
- See an overview of all managed devices and system information in one place
- Monitor and manage devices
- Install firmware to multiple devices of the same model at one time
- Back up and restore device configuration
- View the location of managed devices on a map
- Receive notification for events and alarms, such as when a device goes down
- Graphically monitor individual devices and see related statistics
- Directly access a device for remote configuration

- Create four types of administrators with different privileges
- Perform Site-to-Site, Hub & Spoke, Fully-meshed and Remote Access VPN provisioning.

To allow Cloud CNM SecuManager management of your Zyxel Device:

- You must have a Cloud CNM SecuManager license with CNM ID number or a Cloud CNM SecuManager server URL.
- The Zyxel Device must be able to communicate with the Cloud CNM SecuManager server.

You must configure SecuManager to allow the Zyxel Device to find the Cloud CNM SecuManager server.

## 30.2.1 Introduction to XMPP

eXtensible Messaging and Presence Protocol (XMPP) allows Zyxel Device to contact managed devices that normally can't be contacted directly due to they are behind a NAT or firewall-enabled gateway.

The managed devices must be able to establish a secure and authenticated connection to an XMPP Server and must be able to maintain a connection to an XMPP Server through which the XMPP Server can send unsolicited messages from a defined set of allowed addresses (Zyxel Device servers. This is defined in RFC 6120.

The general procedure for XMPP to issue a Connection Request to a managed device is as follows:

- 1 Zyxel Device establishes a connection to an XMPP Server.
- 2 The device establishes an XMPP connection to the specified XMPP Server.
- 3 Whenever Zyxel Device wishes to establish a connection to the device, it can send an XMPP Connection Request specifying the 'to' address that matches the device where the Connection Request needs to be sent and a 'from' address that matches one of the allowed Zyxel Device addresses in the XMPP Server.
- 4 The XMPP Server sends the request to the appropriate device.

Note: There could be multiple XMPP Servers depending on the deployment.

### 30.2.1.1 Zyxel Device Requirements for XMPP

Both Zyxel Device and the managed device must meet these requirements:

- They must be able to determine the public IP address of the XMPP Server.
- They must be able to open an XML Stream to the XMPP Server and accept an XML Stream from the XMPP Server. XML Streams are unidirectional and this XMPP Connection Request mechanism requires the use of two XML Streams over a single TCP connection.
- They must be able to use Transport Layer Security (TLS) to establish an encrypted and secure TCP connection with the XMPP Server
- They must be able to use Simple Authentication and Security Layer (SASL) to authenticate with the XMPP Server. A Username and Password are used as the credentials for the SASL authentication procedure.
- They must be able to reestablish the connection to the XMPP Server if the connection is lost.

### 30.2.1.2 Managed Device Additional Requirements

The managed device must also meet these requirements:

- A managed device must be able to maintain the TCP connection to the XMPP Server using 'whitespace keepalive'.
- A managed device must be able to listen for XMPP Connection Request messages sent from an allowed list, and respond to these messages when they arrive. When it receives an XMPP Connection Request message, it must both validate and authenticate the message. It must also continue to listen for HTTP-based Connection Requests.
- Whenever a managed device receives, successfully validates, and authenticates an XMPP Connection Request with a Zyxel Device server from an allowed IP address, it must establish a connection with Zyxel Device server and will respond with a '6 CONNECTION REQUEST' EventCode.
- The managed device may reply with a 'service- unavailable' error, code 503, if the number of connection requests exceeds a certain threshold (to reduce the possibility of a Denial of Service attack) or if it is already in a session with another Zyxel Device server.

## 30.2.2 Cloud CNM SecuManager Commands

The CNM agent allows communications between the Zyxel Device and Cloud CNM SecuManager server using TR-069 Remote Procedure Calls (RPCs).

You must be in configuration mode (`configure terminal`) to use the indented commands shown below.

Table 121 Command Summary: Cloud CNM SecuManager

COMMAND	DESCRIPTION
<code>show cnm-agent configuration</code>	Displays current Cloud CNM SecuManager network management configuration on the Zyxel Device.
<code>[no] cnm-agent activate</code>	Allows management of the Zyxel Device by a Cloud CNM SecuManager server.  The <code>no</code> command disallows management of the Zyxel Device by a Cloud CNM SecuManager server.
<code>[no] cnm-agent auto-get-acs activate</code>	Automatically lets the Zyxel Device get the Cloud CNM SecuManager server URL from myZyxel. The Cloud CNM SecuManager server must be able to access myZyxel and you must have a CNM ID from the Cloud CNM license.  The <code>no</code> command disallows the Zyxel Device getting the Cloud CNM SecuManager server URL from myZyxel, so you must manually configure it.
<code>(no) cnm-agent enable-cnm-id</code>	Allows Cloud CNM SecuManager to get the URL from myZyxel.  The <code>no</code> command means you must provide a CNM URL using <code>cnm-agent manager {https_url http_url}</code>
<code>[no] cnm-agent cnm-id &lt;ID&gt;</code>	The CNM ID is used by Cloud CNM SecuManager to get the URL from myZyxel. Enter the CNM ID exactly as on the Cloud CNM SecuManager license. The CNM ID can be from 0 to 80 characters long using these characters: <code>[a-zA-Z0-9-][\a-zA-Z0-9_-]</code> .  The <code>no</code> command removes the CNM ID.

Table 121 Command Summary: Cloud CNM SecuManager (continued)

COMMAND	DESCRIPTION
[no] <code>cnm-agent manager</code> { <code>https_url</code>   <code>http_url</code> }	Sets the URL (HTTP or HTTPS) for the Cloud CNM SecuManager server. The string must be less than 255 characters. Enter the IPv4 IP address of the Cloud CNM SecuManager server followed by the port number (default 7547 for HTTPS or 7549 for HTTP) followed by the <b>CNM ID</b> from the license in <b>CNM URL</b> . For example, if you installed Cloud CNM SecuManager on a server with IP address 1.1.1.1 and <b>CNM ID</b> V6ABQNTPYGD, then type <code>1.1.1.1:7547/V6ABQNTPYG</code> or <code>1.1.1.1:7549/V6ABQNTPYG</code> as the <b>CNM URL</b> .  The <code>no</code> command removes the URL (HTTP or HTTPS) for the Cloud CNM SecuManager server.
[no] <code>cnm-agent periodic-inform activate</code>	Enables the Zyxel Device to send Inform messages to the Cloud CNM SecuManager server informing of its presence at regular intervals.  The <code>no</code> command disables the Zyxel Device from sending Inform messages to the Cloud CNM SecuManager server.
[no] <code>cnm-agent periodic-inform interval</code> <10...86400>	Sets how often the Zyxel Device should inform the Cloud CNM SecuManager server of its presence. The valid range for the interval is from 10 to 86400 seconds.  The <code>no</code> command removes the interval.
[no] <code>cnm-agent acs username</code> <i>tr069_acs_username</i>	Sets the Cloud CNM SecuManager connection request user name. The user name can be from 0 to 254 characters long using these characters: [a-zA-Z0-9][\a-zA-Z0-9_].  The <code>no</code> command removes the TR069 account user name.
[no] <code>cnm-agent acs password</code> <i>tr069_acs_password</i>	Sets the Cloud CNM SecuManager connection request password associated with the user name. The password can be from 0 to 254 characters long using these characters: [a-zA-Z0-9][\a-zA-Z0-9_].  The <code>no</code> command removes the password.
[no] <code>cnm-agent password</code>	Sets the password to authenticate the Zyxel Device.  The <code>no</code> command removes the password.
[no] <code>cnm-agent vantage certificate</code> <i>tr069_cert_file_name</i>	Sets the Cloud CNM SecuManager server's certificate in HTTPS authentication as TR-069 needs to verify this. The certificate name can be from 1 to 127 characters long using these characters: [a-zA-Z0-9_\.-].  The <code>no</code> command disables using the server's certificate in HTTPS authentication.
[no] <code>cnm-agent authentication enable</code>	Sets authentication of the Cloud CNM SecuManager server's certificate.  The <code>no</code> command disables authentication.
<code>cnm-agent server-type</code> [ <code>vantage</code>   <code>tr069</code> ]	Sets the management server to be Vantage or Cloud CNM SecuManager. At the time of writing, Vantage is no longer supported.
[no] <code>cnm-agent auto-get-ac</code> <code>acs activate</code>	Allows the Zyxel Device to get the Cloud CNM SecuManager URL from myZyxel.  The <code>no</code> command disallows the Zyxel Device from getting the Cloud CNM SecuManager URL from myZyxel.
[no] <code>cnm-agent trigger-inform</code> <0..8640>	Specifies the time interval for the Zyxel Device to send Inform messages. The valid range for the interval is in 10-second multiples where 0 means 0 to 10 seconds, 1 means 10 to 20 seconds, and so on.  The <code>no</code> command removes the interval.

Table 121 Command Summary: Cloud CNM SecuManager (continued)

COMMAND	DESCRIPTION
[no] <code>cnm-agent username</code>	Creates a Zyxel Device user for Cloud CNM SecuManager authentication. The user name can be from 0 to 254 characters long using these characters: [a-zA-Z0-9-][\a-zA-Z0-9_-].  The <code>no</code> command removes the Zyxel Device user from Cloud CNM SecuManager authentication.
[no] <code>cnm-agent xmpp-domain xmpp_domain</code>	Enter the XMPP domain name of the Cloud CNM SecuManager. The XMPP domain can be from 0 to 80 characters long using these characters:[a-zA-Z0-9-][\a-zA-Z0-9_-].  The <code>no</code> command removes the domain name of the Cloud CNM SecuManager.
[no] <code>cnm-agent xmpp-host xmpp_host</code>	Enter the IP address or FQDN of the Cloud CNM SecuManager.  The <code>no</code> command removes the IP address or FQDN of the Cloud CNM SecuManager.
[no] <code>cnm-agent xmpp-password xmpp_password</code>	Enter the password of the Cloud CNM SecuManager. The XMPP password can be from 0 to 80 characters long using these characters: [a-zA-Z0-9-][\a-zA-Z0-9_-].  The <code>no</code> command removes the password of the Cloud CNM SecuManager.
[no] <code>cnm-agent xmpp-resource xmpp_resource</code>	Enter the XMPP resource ID of the Cloud CNM SecuManager. The XMPP resource ID can be from 0 to 80 characters long using these characters: [a-zA-Z0-9-][\a-zA-Z0-9_-].  The <code>no</code> command removes the XMPP resource ID of the Cloud CNM SecuManager.
[no] <code>cnm-agent xmpp-username xmpp_username</code>	Enter the XMPP account user name of the Cloud CNM SecuManager. The XMPP account user name can be from 0 to 80 characters long using these characters: [a-zA-Z0-9-][\a-zA-Z0-9_-]  The <code>no</code> command removes the XMPP account user name of the Cloud CNM SecuManager.
[no] <code>cnm-agent encrypted-xmpp-password</code>	Enter the XMPP account encrypted password of the Cloud CNM SecuManager.  The <code>no</code> command removes the XMPP account encrypted password of the Cloud CNM SecuManager.

### 30.2.3 Cloud CNM SecuManager Command Example

The following example shows what Cloud CNM SecuManager configurations you have made.

```
Router# show cnm-agent configuration
Activate: NO
ACS URL:
ACS Username:
ACS Password:
Username:
Password:
Server Type: TR069 ACS
Periodic Inform: DISABLE
Periodic Inform Interval: 3600
HTTPS Authentication: NO
Vantage Certificate:
Auto-get-ACS Activate: NO
CNM-ID:
XMPP Activate: NO
XMPP Username:
XMPP Domain:
XMPP Resource:
XMPP Host:
Router#
```

## 30.3 Cloud CNM SecuReporter

Cloud CNM SecuReporter is a security analytics portal accessible using a web browser, that collects and analyzes logs from SecuReporter-licensed Zyxel Devices in order to identify anomalies, alert on potential internal / external threats, and report on network usage. You need to buy a SecuReporter license for your Zyxel Device and register it at myZyxel using your myZyxel account. The Zyxel Device must be able to communicate with the myZyxel server.

Cloud CNM SecuReporter can simultaneous support up to 40,000 units at the time of writing. The following table lists the supported ZyXEL device models:

Table 122 SecuReporter Supported ZyXEL device Models

MODEL	VERSION
ZyWALL USG Series	ZLD4.32 and later
ZyWALL ATP series	ZLD4.32 and later

### 30.3.1 Cloud CNM SecuReporter Commands

SecuReporter stores logs in a temporary file for uploading to the SecuReporter portal for security analysis. How often to upload is determined by the upload interval (default every 300 seconds) or upload file size (default is when the temporary log file reaches 10 MB). More frequent uploads provides better real-time log analysis, but uses more bandwidth and CPU processing power.



You must be in configuration mode (`configure terminal`) to use the indented commands shown below.

Table 123 Command Summary: Cloud CNM SecuReporter

COMMAND	DESCRIPTION
<code>secu-reporter activate {no   yes}</code>	Use <code>yes</code> to send security-related logs to the SecuReporter portal. Use <code>no</code> to disable SecuReporter logging.  SecuReporter must be enabled to collect and analyze logs from this Zyxel Device. <ul style="list-style-type: none"> <li>You must read and accept the General Data Protection Regulation (GDPR) privacy policy by enabling SecuReporter in the Web Configurator before you can enable it by using the CLI.</li> <li>SecuReporter is enabled by default if you have activated a SecuReporter Standard license,</li> <li>SecuReporter is disabled by default if you have a SecuReporter Trial license.</li> <li>You cannot enable SecuReporter if you do not have a SecuReporter license.</li> </ul>
<code>show service-register status secu-reporter</code>	Displays current Cloud CNM SecuReporter registration status at myZyxel.
<code>show secu-reporter status</code>	Displays current Cloud CNM SecuReporter status on this Zyxel Device.
<code>secu-reporter traffic-log {activate   deactivate}</code>	Use <code>activate</code> to send traffic logs to the SecuReporter portal for application usage analysis via this Zyxel Device. This may cause an increase in traffic to SecuReporter from this Zyxel Device. Use <code>deactivate</code> to disable sending traffic logs if it impacts Zyxel Device performance.
<code>secu-reporter upload-filesize &lt;1..10&gt;</code>	A temporary log file is uploaded to the SecuReporter security analytics portal when it meets the size set here (in megabytes) or the interval defined in the following field. 10 MB is the default. Set it to a smaller number for more frequent uploads.
<code>secu-reporter upload-interval &lt;60..600&gt;</code>	A temporary log file is uploaded to the SecuReporter security analytics portal at the interval defined here or when it meets the size set in the previous field. 300 seconds is the default. Set it to a smaller number for more frequent uploads.
<code>secu-reporter adp {activate deactivate}</code>	The <code>activate</code> command will have the Zyxel Device send ADP logs to SecuReporter for analysis and trend spotting.
<code>secu-reporter anti-spam {activate deactivate}</code>	The <code>activate</code> command will have the Zyxel Device send anti-spam logs to SecuReporter for analysis and trend spotting.
<code>secu-reporter anti-virus {activate deactivate}</code>	The <code>activate</code> command will have the Zyxel Device send anti-virus logs to SecuReporter for analysis and trend spotting.
<code>secu-reporter ap-managed {activate deactivate}</code>	The <code>activate</code> command will have the Zyxel Device send logs of the APs connected to the Zyxel Device to SecuReporter for analysis and trend spotting.
<code>secu-reporter app-patrol {activate deactivate}</code>	The <code>activate</code> command will have the Zyxel Device send application patrol logs to SecuReporter for analysis and trend spotting.
<code>secu-reporter content-filter {activate deactivate}</code>	The <code>activate</code> command will have the Zyxel Device send content filtering and URL Threat filtering logs to SecuReporter for analysis and trend spotting.
<code>secu-reporter idp {activate deactivate}</code>	The <code>activate</code> command will have the Zyxel Device send IDP logs to SecuReporter for analysis and trend spotting.
<code>secu-reporter interface-statistics {activate deactivate}</code>	The <code>activate</code> command will have the Zyxel Device send logs of interface statistics to SecuReporter for analysis and trend spotting.

Table 123 Command Summary: Cloud CNM SecuReporter (continued)

COMMAND	DESCRIPTION
<code>secu-reporter reputation-filter {activate deactivate}</code>	The activate command will have the Zyxel Device send IP reputation and URL Threat filter logs to SecuReporter for analysis and trend spotting.  Note: This command is for the ATP series.
<code>secu-reporter sandbox {activate deactivate}</code>	The activate command will have the Zyxel Device send sandboxing logs to SecuReporter for analysis and trend spotting.  Note: This command is for the ATP series.
<code>secu-reporter traffic-log {activate deactivate}</code>	The activate command will have the Zyxel Device send traffic logs to SecuReporter for analysis and trend spotting.
<code>secu-reporter vpn {activate deactivate}</code>	The activate command will have the Zyxel Device send VPN logs to SecuReporter for analysis and trend spotting.
<code>secu-reporter anti-botnet {activate deactivate}</code>	The activate command will have the Zyxel Device send URL Threat filtering logs to SecuReporter for analysis and trend spotting.  Note: This command is for the ATP series.
<code>show secu-reporter category status</code>	Displays the activation status of each service logged by SecuReporter.

### 30.3.2 Cloud CNM SecuReporter Commands Example

The following example shows Cloud CNM SecuReporter registration, configurations and configuration status.

```
Router# show service-register status secu-reporter
Service                Status          Type          Count
Expiration Grace Purchasable Activatable
=====
SecuReporter          Activated      Standard      N/A  295
0      N/A          0
Router# configure terminal
Router(config)# secu-reporter activate yes
Router(config)# secu-reporter traffic-log activate
Router(config)# secu-reporter upload-filesize 5
Router(config)# secu-reporter upload-interval 100
Router(config)# exit
Router# show secu-reporter status
activate: yes
send-reporter: yes
upload-interval: 100
upload-filesize: 5
traffic-log: activate
Router#
```

# CHAPTER 31

# Web Authentication

## 31.1 Web Authentication Overview

Web authentication intercepts network traffic, according to the authentication policies, until the user authenticates his or her connection through a specifically designated login web page. This means all web page requests can initially be redirected to a special web page that requires users to authenticate their sessions. Once authentication is successful, the user can then connect to the rest of the network or Internet.

As soon as a user attempt to open a web page, the Zyxel Device reroutes the user's browser to a web portal page that prompts the user to log in.

### 31.1.1 User Two-Factor Authentication

Two-factor authentication adds an extra layer of security for users logging into the Zyxel Device. When two-factor authentication is enabled, a user has to first enter their username and password, and then enter a second one-time password when logging in.

Web authentication supports two-factor authentication using Google Authenticator. When enabled, the web authentication page first prompts the user to enter their username and password (factor 1), and then prompts them to enter a time-limited code from the Google Authenticator app (factor 2).

Note: It is also possible to configure two-factor authentication for VPN and admin users. For details, see [Section 56.4 on page 467](#).

Note: The admin two-factor authentication settings override the web authentication two-factor authentication settings if both are configured.

#### 31.1.1.1 Google Authenticator

The following is a list of specifications and limitations on using Google Authenticator for two-factor authentication.

- ext-users (external users) are not supported.
- A user must setup Google Authenticator on their mobile device before they can successfully authenticate with the Zyxel Device.
- Verification code length: 6 digits.
- Maximum verification code failed attempts: 3
- Backup code length: 8 digits
- Google authenticator is supported in device High Availability (HA) mode. The secret keys are synchronized between all Zyxel Devices.

### 31.1.2 802.1X Single Sign-On

802.1X Single Sign-On allows the Zyxel Device to use the same username and password for 802.1X WiFi authentication and web authentication. When enabled, a user logs into a WiFi network on the Zyxel Device that has 802.1X (WPA Enterprise) enabled. The Zyxel Device then reuses the 802.1X username and password for web authentication, preventing the user from having to log in twice.

Note: Active Directory Single Sign-On takes priority over 802.1X Single Sign-On, if both are enabled.

### 31.1.3 Summary of User Authentication Methods

The following table summarizes how users authenticate with the Zyxel Device when web authentication is enabled.

Table 124 User Authentication Methods

CLIENT	SINGLE SIGN-ON	GOOGLE AUTHENTICATOR	USER AUTHENTICATION STEPS
802.1X	No	No	1. 802.1X - Username/password 2. Web Authentication Portal - Username/password
	No	Yes	1. 802.1X - Username/password 2. Web Authentication Portal - Username/password 3. Web Authentication Portal - Google Authenticator code
	Yes (802.1X SSO)	No	1. 802.1X - Username/password
	Yes (802.1X SSO)	Yes	1. 802.1X - Username/password 2. Web Authentication Portal - Google Authenticator code
Non-802.1X	No	No	1. Web Authentication Portal - Username/password
	No	Yes	1. Web Authentication Portal - Username/password 2. Web Authentication Portal - Google Authenticator code
	Yes (Active Directory SSO)	No	None needed (if user is using Windows)
	Yes (Active Directory SSO)	Yes	None needed (if user is using Windows)

## 31.2 Web Authentication Commands

This table lists the commands for forcing user authentication. You must use the `configure terminal` command to enter the configuration mode before you can use these commands.

Table 125 web-auth Commands

COMMAND	DESCRIPTION
[no] web-auth activate	Enables force user authentication that force users to log in to the Zyxel Device before the Zyxel Device routes traffic for them. The no command means the user authentication is not required.
web-auth default-rule authentication {required   unnecessary} {no log   log [alert]}	<p>Sets the default authentication policy that the Zyxel Device uses on traffic that does not match any exceptional service or other authentication policy.</p> <p><b>required:</b> Users need to be authenticated. They must manually go to the Zyxel Device's login screen. The Zyxel Device will not redirect them to the login screen.</p> <p><b>unnecessary:</b> Users do not need to be authenticated.</p> <p><b>no log   log [alert]:</b> Select whether to have the Zyxel Device generate a log (log), log and alert (log alert) or not (no log) for packets that match this default policy.</p>
web-auth [no] exceptional-service service_name	Sets a service which you want users to be able to access without user authentication. The no command removes the specified service from the exceptional list.
web-auth google-auth valid-time <1..5>	<p>Sets maximum time, in minutes, that a user has to authenticate using Google Authenticator before the authentication attempt fails.</p> <p>The setting only takes effect if Google Authenticator is enabled in the web authentication policy.</p>
web-auth login setting	Sets the login web page through which the user authenticates his or her connection before he or she can then connect to the rest of the network or Internet. See <a href="#">Table 127 on page 248</a> for the sub-commands.
web-auth method portal	Sets a client to authenticate with the Zyxel Device through the specifically designated web portal.
web-auth policy <1..1024>	Creates the specified condition for forcing user authentication, if necessary, and enters sub-command mode. The conditions are checked in sequence, starting at 1. See <a href="#">Table 127 on page 248</a> for the sub-commands.
web-auth policy append	Creates a new condition for forcing user authentication at the end of the current list and enters sub-command mode. See <a href="#">Table 127 on page 248</a> for the sub-commands.
web-auth policy insert <1..1024>	Creates a new condition for forcing user authentication at the specified location, renumbers the other conditions accordingly, and enters sub-command mode. See <a href="#">Table 127 on page 248</a> for the sub-commands.
web-auth policy delete <1..1024>	<p>Deletes the specified condition.</p> <p>To modify a condition, you can insert a new condition (N) and then delete the one (N+1) that you want to modify.</p>
web-auth policy flush	Deletes every condition.
web-auth policy move <1..1024> to <1..1024>	Moves the specified condition to the specified location and renumbers the other conditions accordingly.
[no] web-auth redirect-fqdn host_str	<p>Set the Fully-Qualified Domain Name (FQDN) of the Zyxel Device interface to which the clients connect.</p> <p>The no command removes the specified FQDN.</p> <p><i>host_str</i>: the fully qualified domain name for the host.</p>

Table 125 web-auth Commands (continued)

COMMAND	DESCRIPTION
<code>show web-auth redirect-fqdn</code>	Displays the FQDN of the Zyxel Device interface to which the clients connect to authenticate through the internal web portal page
<code>web-auth redirect-parameter</code>	<p>Enters redirect parameter subcommand mode, and change the names of the following parameters.</p> <ul style="list-style-type: none"> <li>• <code>ap_ip</code></li> <li>• <code>ap_mac</code></li> <li>• <code>client_ip</code></li> <li>• <code>client_mac</code></li> <li>• <code>ssid_name</code></li> <li>• <code>vlan_id</code></li> </ul> <p>To use an external web portal for web authentication, you need to use the parameters' names that are adopted by the external web portal. Thus, you can be directed successfully to the external web portal.</p> <p>The Zyxel Device will automatically add these parameters to the URL of the external web portal when you're directed to the web portal for web authentication.</p>
<code>{ap_ip ap_mac client_ip client_mac ssid_name vlan_id} new_parameter</code>	<p>Changes the name of the following parameters. You can only change a parameter's name at a time.</p> <p><code>{ap_ip ap_mac client_ip client_mac ssid_name vlan_id}</code>: Enters the parameter of which you want to change the name.</p> <p><i>new_parameter</i>: Enters a new name for the parameter.</p>
<code>mac_delimiter {colon hyphen}</code>	<p>Specifies the separator the external server uses for the two-character pairs within MAC addresses used.</p> <p>For example, use <code>mac delimiter hyphen</code> if you need to use a MAC address formatted like 00-11-AC-01-A0-11.</p>
<code>no web-auth redirect-parameter</code>	Resets the names of the parameters to the default settings.
<code>show web-auth redirect-parameter</code>	<p>Displays the names of the following parameters:</p> <ul style="list-style-type: none"> <li>• <code>ap_ip</code></li> <li>• <code>ap_mac</code></li> <li>• <code>client_ip</code></li> <li>• <code>client_mac</code></li> <li>• <code>ssid_name</code></li> <li>• <code>vlan_id</code></li> </ul>
<code>web-auth web-portal</code>	Enters web portal subcommand mode.
<code>session-page {activate   deactivate}</code>	Redirects to a 'Welcome page' after login when activated.
<code>show web-auth activation</code>	Displays whether forcing user authentication is enabled or not.
<code>show web-auth default-rule</code>	Displays settings of the default web authentication policy.
<code>show web-auth exceptional-service</code>	Displays services that users can access without user authentication.
<code>show web-auth method</code>	Displays whether a client is to authenticate with the Zyxel Device through the specifically designated web portal when web authentication is enabled.
<code>show web-auth policy {&lt;1..1024&gt;   all}</code>	Displays details about the policies for forcing user authentication.

Table 125 web-auth Commands (continued)

COMMAND	DESCRIPTION
show web-auth portal status	Displays the web portal page settings.
show web-auth status	Displays the web portal page settings.

## 31.2.1 web-auth login setting Sub-commands

The following table describes the sub-commands for the web-auth login setting command.

Table 126 web-auth login setting Sub-commands

COMMAND	DESCRIPTION
exit	Leaves the sub-command mode.
type {external   internal}	<p>Sets the login page appears whenever the web portal intercepts network traffic, preventing unauthorized users from gaining access to the network.</p> <p>internal: Use the default login page built into the Zyxel Device.</p> <p>external: Use a custom login page from an external web portal instead of the default one built into the Zyxel Device. You can configure the look and feel of the web portal page.</p> <p>Note: If you select the external option, you cannot use endpoint security to make sure that users' computers meet specific security requirements before they can access the network.</p>
[no] error-url url	<p>Sets the error page's URL; for example, http://IIS server IP Address/error.html. You can use up to 255 characters (0-9a-zA-Z/?:@&amp;+\$. _!~'()) in quotes.</p> <p>The no command removes the URL.</p> <p>The Internet Information Server (IIS) is the web server on which the web portal files are installed.</p>
[no] internal-welcome-url url	<p>Sets the welcome page's URL when you select to use the default login page built into the Zyxel Device; for example, http://IIS server IP Address/welcome.html. You can use up to 255 characters (0-9a-zA-Z/?:@&amp;+\$. _!~'()) in quotes.</p> <p>The no command removes the URL.</p> <p>The Internet Information Server (IIS) is the web server on which the web portal files are installed.</p>
[no] login-url url	<p>Sets the login page's URL; for example, http://IIS server IP Address/login.html. You can use up to 255 characters (0-9a-zA-Z/?:@&amp;+\$. _!~'()) in quotes.</p> <p>The no command removes the URL.</p> <p>The Internet Information Server (IIS) is the web server on which the web portal files are installed.</p>
[no] logout-ip ipv4_address	<p>Sets an IP address that users can use to terminate their sessions manually by entering the IP address in the address bar of the web browser.</p> <p>The no command removes the IP address.</p>

Table 126 web-auth login setting Sub-commands (continued)

COMMAND	DESCRIPTION
[no] <code>logout-url url</code>	<p>Sets the logout page's URL; for example, <code>http://IIS server IP Address/logout.html</code>. You can use up to 255 characters (0-9a-zA-Z/?:@&amp;=+\$\._!-'()%,) in quotes.</p> <p>The <code>no</code> command removes the URL.</p> <p>The Internet Information Server (IIS) is the web server on which the web portal files are installed.</p>
[no] <code>session-url url</code>	<p>Sets the session page's URL; for example, <code>http://IIS server IP Address/session.html</code>. You can use up to 255 characters (0-9a-zA-Z/?:@&amp;=+\$\._!-'()%,) in quotes.</p> <p>The <code>no</code> command removes the URL.</p> <p>The Internet Information Server (IIS) is the web server on which the web portal files are installed.</p>
[no] <code>terms-of-service</code>	<p>Forces users to agree to the terms before they can use the service. An agreement checkbox will display in the login page.</p> <p>The <code>no</code> command allows users to use the service without agreeing to the terms.</p>
[no] <code>welcome-url url</code>	<p>Sets the welcome page's URL; for example, <code>http://IIS server IP Address/welcome.html</code>. You can use up to 255 characters (0-9a-zA-Z/?:@&amp;=+\$\._!-'()%,) in quotes.</p> <p>The <code>no</code> command removes the URL.</p> <p>The Internet Information Server (IIS) is the web server on which the web portal files are installed.</p>

## 31.2.2 web-auth policy Sub-commands

The following table describes the sub-commands for an web-auth policy (`web-auth policy 1-1024`). Note that not all rule commands use all the sub-commands listed here.

Table 127 web-auth policy Sub-commands

COMMAND	DESCRIPTION
[no] <code>activate</code>	<p>Activates the specified condition. The <code>no</code> command deactivates the specified condition.</p>
[no] <code>authentication {force   required}</code>	<p>Selects the authentication requirement for users when their traffic matches this policy. The <code>no</code> command means user authentication is not required.</p> <p><code>force</code>: Users need to be authenticated and the Zyxel Device automatically display the login screen when users who have not logged in yet try to send HTTP traffic.</p> <p><code>required</code>: Users need to be authenticated. They must manually go to the login screen. The Zyxel Device will not redirect them to the login screen.</p>
<code>authentication-type {&lt;profile name&gt;   default-user-agreement   default-web-portal   facebook-wifi}</code>	<p>Select the authentication type profile you want to use in this policy.</p> <p><code>facebook-wifi</code> is available when you enable Facebook Wi-Fi on the Zyxel Device.</p> <p>Note: If you set the authentication type to <code>facebook-wifi</code>, the destination address must be <code>any</code>.</p> <p>Note: You can configure the <code>web-portal</code> and <code>user-agreement</code> profile using the <code>web-auth type profile</code> commands.</p>



Table 127 web-auth policy Sub-commands (continued)

COMMAND	DESCRIPTION
[no] description <i>description</i>	Sets the description for the specified condition. The <b>no</b> command clears the description.  <i>description:</i> You can use alphanumeric and ( ) + / : = ? ! * # @ \$ _ % - characters, and it can be up to 60 printable ASCII characters long.
[no] destination { <i>address_object</i>   <i>group_name</i> }	Sets the destination criteria for the specified condition. The <b>no</b> command removes the destination criteria, making the condition effective for all destinations.
[no] force	Forces users to log in to the Zyxel Device if the specified condition is satisfied. The <b>no</b> command means that users do not log in to the Zyxel Device.
interface <i>interface_name</i>	Sets an interface on which packets for the policy must be received.
[no] schedule <i>schedule_name</i>	Sets the time criteria for the specified condition. The <b>no</b> command removes the time criteria, making the condition effective all the time.
[no] source { <i>address_object</i>   <i>group_name</i> }	Sets the source criteria for the specified condition. The <b>no</b> command removes the source criteria, making the condition effective for all sources.
[no] sso	Enables single sign-on (SSO) web authentication using Microsoft Active Directory.  When enabled, a user logs into a Windows computer using their Active Directory (AD) username and password. The Zyxel Device then uses these AD credentials for web authentication, through an SSO Agent server.  The <b>no</b> command disables SSO web authentication.
[no] 8021x- <i>sso</i>	Enables single sign-on (SSO) web authentication using 8021x.  When enabled, a user logs into a WiFi network on the Zyxel Device that has 8021.x (WPA Enterprise) enabled. The Zyxel Device then uses the user's 8021.x username and password for web authentication.  The <b>no</b> command disables SSO web authentication using 8021x.
[no] google-auth	Enables 2-factor authentication using Google Authenticator.  When enabled, a user must first authenticate on the web authentication page using their Zyxel Device username and password (this step can be bypassed if SSO or 8021.x-SSO is enabled), The user must then authenticate again by entering a code from the Google Authenticator app.  To successfully authenticate, Google Authentication must already be enabled on the user's account and configured on their mobile device. For details, see <a href="#">Section 56.4 on page 467</a> .
show sso { <i>agent</i>   <i>port</i>   <i>presharekey</i> }	Displays information about the specified condition.

### 31.2.3 Facebook Wi-Fi Commands

This table lists the commands for Facebook Wi-Fi. You must use the `configure terminal` command to enter the configuration mode before you can use these commands.

Table 128 fbwifi Commands

COMMAND	DESCRIPTION
<code>[no] fbwifi activate</code>	Turns on Facebook Wi-Fi on the Zyxel Device. The <code>no</code> command disables it.
<code>[no] fbwifi idle-detection</code>	Sets the Zyxel Device to monitor how long each user (authenticated via Facebook Wi-Fi) is idle. The <code>no</code> command disables the idle detection feature.
<code>fbwifi idle-detection timeout &lt;1..60&gt;</code>	Specifies the user idle timeout between 1 and 60 minutes. The Zyxel Device automatically disconnects a user (authenticated via Facebook Wi-Fi) from the network after a period of inactivity.
<code>fbwifi reset-fbpage</code>	Removes the Facebook Page settings.
<code>fbwifi security {high  low}</code>	<p>Sets when guests have to check into a business owner's Facebook Page.</p> <ul style="list-style-type: none"> <li><code>fbwifi security high</code> (default) only allows HTTP traffic, and blocks all other Internet traffic (HTTPS, FTP, SSH, and so on). Guests can browse using HTTP without checking in to the business owner's Facebook Page. Check-in is necessary for other Internet services such as WeChat, Line and so on.</li> <li><code>fbwifi security low</code> only blocks HTTP traffic, and allows all other Internet traffic (HTTPS, FTP, SSH, and so on). Guests that browse using HTTP will be redirected to the business owner's Facebook Page, and will need to check-in to continue browsing the Internet. Check-in is not necessary for other Internet services such as WeChat, Line and so on.</li> </ul>
<code>show fbwifi activate</code>	Displays whether Facebook Wi-Fi is enabled on the Zyxel Device.
<code>show fbwifi service-register status</code>	Displays whether the Zyxel Device has been registered with myZyXEL.com.
<code>show fbwifi status</code>	Displays Facebook Wi-Fi settings on the Zyxel Device.

## 31.3 SSO Overview

SSO (Single Sign-On) integrates Domain Controller and Zyxel Device authentication mechanisms, so that users just need to log in once (single login) to get access to permitted resources.

- The Zyxel Device, the DC, the SSO agent and the LDAP or AD server must all be in the same domain and be able to communicate with each other.
- SSO does not support IPv6 or RADIUS; you must use it in an IPv4 network environment with Windows AD (Active Directory) or LDAP (Lightweight Directory Access Protocol) authentication databases.
- You must enable Web Authentication to use SSO.

### 31.3.1 SSO Configuration Commands

Use these commands to configure the Zyxel Device to communicate with SSO.

Table 129 SSO Commands and Subcommnds

COMMAND	DESCRIPTION
<code>sso agent primary</code>	Enters SSO primary agent subcommand mode.
<code>sso agent secondary</code>	Enters secondary agent subcommand mode. A secondary agent is an optional backup SSO agent.
<pre>router(config-sso- primary)# router(config-sso- secondary)# [no] ip &lt;w.x.y.z&gt;</pre>	<p>Sets the primary or secondary SSO agent <i>ipv4 address</i>. Use <i>[no]</i> to disable the IPv4 address.</p> <p>Type the IPv4 address of the SSO agent. The Zyxel Device and the SSO agent must be in the same domain and be able to communicate with each other.</p>
<pre>router(config-sso- primary)# router(config-sso- secondary)# [no] port &lt;1025..65535&gt;</pre>	Sets the primary or secondary agent port <i>&lt;1025..65535&gt;</i> . Use <i>[no]</i> to disable the port. Type the same port number here as in the <b>Agent Listening Port</b> field on the SSO agent. Type a number ranging from 1025 to 65535.
<pre>sso presharekey &lt;preshared key&gt;</pre>	Sets the SSO pre-shared key. Type 8-32 printable ASCII characters or exactly 32 hex characters (0-9; a-f). The Agent PreShareKey is used to encrypt communications between the Zyxel Device and the SSO agent
<pre>sso encrypted- presharekey &lt;ciphertext&gt;</pre>	Sets the SSO encrypted pre-shared key.
<code>sso_port &lt;1025..65535&gt;</code>	Sets the SSO listening port. This port is used to wait for receiving information from Agent. Type a number ranging from 1025 to 65535.

### 31.3.2 SSO Show Commands

You don't need to enter the configuration mode before you can use these commands. Use them to see SSO configurations done.

Table 130 SSO Show Commands

COMMAND	DESCRIPTION
<code>show sso agent</code>	Displays primary and secondary agent IP and Port configurations.
<code>show sso agent primary</code>	Displays primary agent IP and Port configurations.
<code>show sso agent secondary</code>	Displays secondary agent IP and Port configurations.
<code>show sso agent status</code>	Displays primary and secondary agent status.
<code>show sso port</code>	Displays the ZySSO port configured.
<code>show sso presharekey</code>	Shows the configured ZySSO presharekey.

### 31.3.3 Command Setup Sequence Example

The following commands show how to configure the Zyxel Device to communicate with an SSO agent at IP address '1.1.1.1', using port '2158' and preshared key '12345678'.

```
Router(config)# sso agent primary
Router(config-sso-primary)# ip 1.1.1.1
Router(config-sso-primary)# port 2158
Router(config-sso-primary)# exit
Router(config)# sso presharekey 12345678
Router(config)# sso port 2158
Router(config)# exit
Router# show sso agent
Agent: primary
  IP Address: 1.1.1.1
  Port: 2158
Agent: secondary
  IP Address:
  Port: 0
Router# show sso agent primary
Agent: primary
  IP Address: 1.1.1.1
  Port: 2158
Router# show sso agent secondary
Agent: secondary
  IP Address:
  Port: 0
Router# show sso agent status
ZySSO Primary Agent: Offline
ZySSO Primary Agent: Offline
Router# show sso port
ZySSO port: 2158
Router# show sso presharekey
ZySSO presharekey: 12345678
Router#
```

### 31.3.4 Two-Factor Web Authentication Command Example

The following example shows how to enable web authentication with two-factor authentication for clients on LAN1, and then configure Google Authenticator for a user account.

Note: After running `show username <USERNAME> google-auth qrcode`, the owner of account TestUser needs to add the QRCode key manually to their Google Authenticator app..

```
Router# show web-auth policy all
force authentication policy: 1
  active: yes
  description: LAN1
  incoming interface: lan1
  source address: any
  destination address: any
  authentication: force
  sso: no
  schedule: none
  authentication type: default-web-portal
  ieee8021x sso: no
  google auth: no
Router# configure terminal
Router(config)# web-auth activate
Router(config)# web-auth policy 1
Router(config-web-auth-1)# google-auth
Router(config-web-auth-1)# exit
Router(config)# username TestUser google-auth
Router(config)# show username TestUser google-auth qrcode
qrcode-url# otpauth://totp/
admin?secret=XXXXXXXXXXXXXXXXXXXXXXXXXXXX&issuer=atp100w
Router(config)# username TestUser google-auth verify-code 123456
Verify: Success
```

# CHAPTER 32

## Hotspot

### 32.1 Hotspot Overview

See the Introduction chapter of the ZyWALL USG Series User's Guide for a list of models that support Hotspot management.

### 32.2 Billing Overview

You can use the built-in billing function to set up billing profiles. A billing profile describes how to charge users. This chapter also shows you how to select an accounting method or configure a discount price plan.

### 32.3 Billing Commands

This table lists the `billing` commands. You must use the `configure terminal` command to enter the configuration mode before you can use these commands.

Table 131 `billing` Commands

COMMAND	DESCRIPTION
<code>billing accounting-method {accumulation   time-to-finish }</code>	Sets how the Zyxel Device accounts the time.  <code>accumulation</code> : to allow each user a one-time login. Once the user logs in, the system starts counting down the pre-defined usage even if the user stops the Internet access before the time period is finished. If a user disconnects and reconnects before the allocated time expires, the user does not have to enter the user name and password to access the Internet again  <code>time-to-finish</code> : to allow each user multiple re-login until the time allocated is used up. The Zyxel Device accounts the time that the user is logged in for Internet access
<code>billing accumulation idle-detection timeout &lt;1..60&gt;</code>	Specifies the idle timeout between 1 and 60 minutes. The Zyxel Device automatically disconnects a computer from the network after a period of inactivity. The user may need to enter the username and password again before access to the network is allowed.
<code>billing accumulation-expire {day &lt;1..360&gt;   hour &lt;1..24&gt;}</code>	Specifies a time unit and number to set how long to wait before the Zyxel Device deletes an idle account.
<code>billing currency {eur   gbp   usd   user-define <i>currency_code</i> }</code>	Sets the appropriate currency unit.  <code>currency_code</code> : enter a three-letter alphabetic code, such as TWD or JPY.
<code>billing decimal-places &lt;2&gt;</code>	Sets the number of decimal places to be used for billing.
<code>billing decimal-symbol {comma   dot}</code>	Sets the Zyxel Device to use a dot (.) or a comma (,) for the decimal point.

Table 131 billing Commands (continued)

COMMAND	DESCRIPTION
[no] billing discount activate	Activates the discount price plan. The no command disables the discount price plan.
billing discount button {a   b   c} [charge-by-level]	Specifies a button to assign the base charge.  charge-by-level: to charge the rate at each successive level from the first level (most expensive per unit) to the highest level (least expensive per unit) that the total purchase reaches.
[no] billing discount unit <2..10> price price	Creates a new discount level by setting the duration of the billing period that should be reached before the Zyxel Device charges users at this level and defining this level's charge per time unit.  The no command removes this discount level.
[no] billing profile profile_name	Creates a billing profile and enters the billing profile sub-command mode to set the price and the duration of the billing period. See <a href="#">Table 132 on page 256</a> for the sub-commands.  The no command removes the specified profile.  profile_name: use up to 31 alphanumeric characters (A-Z, a-z, 0-9) and underscores (_). Spaces are not allowed. The first character must be a letter.
billing profile rename profile_name profile_name	Renames the specified billing profile (first profile_name) to the specified name (second profile_name).
billing tax-rate <0..100>	Sets the tax rate. For example, type 6 for a 6% sales tax.
[no] billing tax-rate activate	Sets the Zyxel Device to charge sales tax for the account.  The no command sets the Zyxel Device to not charge sales tax for the account.
billing unused-expire {minute <30..60>   hour <1..24>   day <1..365>}	Specifies a time unit and number to set how long to wait before the Zyxel Device deletes an account that has not been used.
billing username-password-length <4..6>	Sets how many characters the username and password of a newly-created dynamic guest account will have.
[no] billing wlan-ssid-profile profile_name	Sets the name of the SSID profile to which you can apply the general billing settings.  The no command sets the Zyxel Device to not apply the billing settings to the SSID profile.
[no] billing replenish activate	Allows dynamic-guest accounts to purchase additional time units for their accounts before their accounts expire.
show billing discount default rule	Displays settings of the default discount price plan.
show billing discount rule	Displays settings of the custom discount price plan(s).
show billing discount status	Displays billing discount settings.
show billing profile [profile_name]	Displays settings for all or the specified billing profile.
show billing status	Displays the general billing settings, such as the accounting method or tax rate.

### 32.3.1 Billing Profile Sub-commands

The following table describes the sub-commands for the `billing profile` command.

Table 132 billing profile Sub-commands

COMMAND	DESCRIPTION
<code>[no] activate</code>	Enables the billing profile. The <code>no</code> command disables the profile.
<code>bandwidth {upload   download} &lt;0..1048576&gt; priority &lt;1..7&gt;</code>	Specifies the maximum bandwidth allowed for the user account in kilobits per second and types a number between 1 and 7 to set the priority for the user's traffic. The smaller the number, the higher the priority.  <code>upload</code> refers to the traffic the Zyxel Device sends out from a user. <code>download</code> refers to the traffic the Zyxel Device sends to a user.
<code>[no] bandwidth activate</code>	Turns on bandwidth management for the user account. The <code>no</code> command disables bandwidth management for the user account.
<code>price price</code>	Defines each profile's price, up to 999999.99, per time unit.
<code>quota {total   upload   download} megabytes &lt;0..1023&gt;</code>	Sets how much downstream and/or upstream data in Megabytes can be transmitted through the external interface before the account expires. 0 means there is no data limit for the user account.
<code>quota {total   upload   download} gigabytes &lt;0..100&gt;</code>	Sets how much downstream and/or upstream data in Gigabytes can be transmitted through the external interface before the account expires. 0 means there is no data limit for the user account.
<code>quota type {total   upload-download}</code>	Sets a limit for the user account. This only applies to user's traffic that is received or transmitted through the external interface.  Note: When the limit is exceeded, the user is not allowed to access the Internet through the Zyxel Device.  <code>total</code> : set a limit on the total traffic in both directions. <code>upload-download</code> : set a limit on the upstream traffic and downstream traffic respectively.
<code>time-period {day &lt;1..365&gt;   hour &lt;1..24&gt;   minute &lt;30..60&gt;}</code>	Sets the duration of the billing period. When this period expires, the user's access will be stopped.

### 32.3.2 Billing Command Example

This example sets the accounting method to `time-to-finish` and configures the idle timeout that elapses before the Zyxel Device disconnects a user.

```
Router# configure terminal
Router(config)# billing accounting-method time-to-finish
Router(config)# billing accumulation idle-detection timeout 30
Router(config)#
```



This example enables and creates a custom discount pricing plan. It uses button A to assign the base charge and also shows the discount status and plan settings.

```
Router# configure terminal
Router(config)# billing discount activate
Router(config)# billing discount button a charge-by-level
Router(config)# billing discount unit 3 price 1.9
Router(config)# show billing discount status
Billing discount status:
  activate: yes
  button: a
  charge_by_level: yes
Router(config)# show billing discount rule
No.  Conditions          Unit          Unit price
=====
====
1    when >=           3             eur  1,90
Router(config)#
```

This example creates a billing profile named `billing_1hour` and displays the profile settings.

```
Router# configure terminal
Router(config)# billing profile billing_1hour
Router(billing profile button-a)# activate
Router(billing profile button-a)# price 2
Router(billing profile button-a)# time-period hour 1
Router(billing profile button-a)# exit
Router(config)# show billing profile
Billing Profile: billing_30mins
  activate: yes
  time period: 30 minute
  price: eur 0,00
Billing Profile: billing_1hour
  activate: yes
  time period: 1 hour
  price: eur 2,00
Router(config)#
```

This example applies the billing profile `billing_1hour` to button A of the web-based account generator and button A on a connected statement printer. It also displays the default discount price plan settings, that is, the billing profile settings for button A when it is selected as the button to assign the base charge.

```
Router# configure terminal
Router(config)# printer-manager button a billing_1hour
Router(config)# show billing discount default rule
No.  Conditions          Unit          Unit price
=====
====
default  when >=           1             eur  2,00
Router(config)#
```

### 32.3.3 Payment Service

Use these commands to use a credit card service to authorize, process, and manage credit card transactions directly through the Internet. You must register with the supported credit card service before you can configure the Zyxel Device to handle credit card transactions.

This table lists the `payment-service` commands. You must use the `configure terminal` command to enter the configuration mode before you can use these commands.

Table 133 `payment-service` Commands

COMMAND	DESCRIPTION
<code>payment-service provider select provider</code>	Selects a payment provider. For example, <code>payment-service provider select paypal</code> .
<code>payment-service provider paypal</code>	Enters <code>payment-service</code> sub-command mode for PayPal.
<code>payment-service provider paypal exit</code>	Exits <code>payment-service</code> sub-command mode.
<code>[no] payment-service activate</code>	Activates payment service to use PayPal to authorize credit card payments. The <code>no</code> command disables payment service.
<code>payment-service account-delivery delivery_method {deactivate   activate}</code>	Enables or disables how the Zyxel Device provides dynamic guest account information after the user's online payment is done.  <i>delivery_method</i> : type <i>onscreen</i> or <i>sms</i> . <i>onscreen</i> displays the user account information in the web configurator screen. <i>sms</i> uses Short Message Service (SMS) to send account information in a text message to the user's mobile device. You should have enabled SMS to send text messages to the user's mobile device.
<code>[no] payment-service page-customization</code>	Enables customization of desktop online payment service pages that displays after an unauthorized user clicks the link in the Web Configurator login screen to purchase access time.  The <code>no</code> command disables customization and uses the default page.
<code>[no] payment-service mobile-page-customization</code>	Enables customization of mobile online payment service pages that displays after an unauthorized user clicks the link in the Web Configurator login screen to purchase access time.  The <code>no</code> command disables customization and uses the default page.
<code>payment-service fail-page failed-message message</code>	Creates a message if a desktop payment transaction fails.  <i>message</i> : The message must be from 1 to 256 characters long and can contain spaces and the following characters ([0-9a-zA-Z "()+,/:;=-!*#@\$_%-\.&?[\]\{\}\^*\   ^\ \ \ \ < \ > \ + \ "])  The default message is "Sorry! We can't handle your payment transaction at this time."
<code>payment-service mobile-fail-page failed-message message</code>	Creates a message if a mobile payment transaction fails.  <i>message</i> : The message must be from 1 to 256 characters long and can contain spaces and the following characters ([0-9a-zA-Z "()+,/:;=-!*#@\$_%-\.&?[\]\{\}\^*\   ^\ \ \ \ < \ > \ + \ "])  The default message is "Sorry! We can't handle your payment transaction at this time."

Table 133 payment-service Commands (continued)

COMMAND	DESCRIPTION
payment-service mobile-profile-page selection-message <i>message</i>	<p>Creates a message prompting mobile payment service plan selection.</p> <p><i>message</i>: The message must be from 1 to 256 characters long and can contain spaces and the following characters ([0-9a-zA-Z "()+,/:;=!*#@\$_%-\.\&amp;\?[\]\{\}\^*\ \\\&lt;\&gt;\+\\")</p> <p>The default message is "Please choose the service plan from the following profile table."</p>
payment-service mobile-sms-page info-message <i>message</i>	<p>Creates a mobile view customized SMS page when a new account is created.</p> <p><i>message</i>: The message must be from 1 to 256 characters long and can contain spaces and the following characters ([0-9a-zA-Z "()+,/:;=!*#@\$_%-\.\&amp;\?[\]\{\}\^*\ \\\&lt;\&gt;\+\\")</p> <p>The default message is "Please check your mobile phone for the account information."</p>
payment-service mobile-success-page {notification-message   successful-message   notification-message-color {#00FF00   color_name   rgb(0,0,255)}}	<p>Creates custom colored mobile view messages when a new account is created successfully.</p> <p><i>message</i>: The message must be from 1 to 256 characters long and can contain spaces and the following characters ([0-9a-zA-Z "()+,/:;=!*#@\$_%-\.\&amp;\?[\]\{\}\^*\ \\\&lt;\&gt;\+\\")</p> <p>The default notification-message is "IMPORTANT! Make a note for your case-sensitive username and password for logging later. This will be your only opportunity to do so."</p> <p>The default successful-message is "You may now use the Internet."</p> <p>notification-message-color: Defines the message color by selecting RGB (0,0,255), or type a <i>color_name</i> such as red, or enter the hex color format (#00FF00).</p>
payment-service profile-page selection-message <i>message</i>	<p>Creates a message prompting payment service plan selection.</p> <p><i>message</i>: The message must be from 1 to 256 characters long and can contain spaces and the following characters ([0-9a-zA-Z "()+,/:;=!*#@\$_%-\.\&amp;\?[\]\{\}\^*\ \\\&lt;\&gt;\+\\")</p> <p>The default message is "Please choose the service plan from the following profile table."</p>
payment-service success-page {account-message <i>message</i>   format-date {dd-mm-yyyy   mm-dd-yyyy   yyyy-mm-dd}   notification-message <i>message</i>   notification-message-color {#00FF00   color_name   rgb(0,0,255)}   successful-message <i>message</i> }	<p>Creates custom colored, date-formatted desktop view messages when a new account is created successfully.</p> <p><i>message</i>: The message must be from 1 to 256 characters long and can contain spaces and the following characters ([0-9a-zA-Z "()+,/:;=!*#@\$_%-\.\&amp;\?[\]\{\}\^*\ \\\&lt;\&gt;\+\\")</p> <p>The default account-message is "This is your account information, please keep this for your internet service."</p> <p>The default notification-message is "IMPORTANT! Make a note for your case-sensitive username and password for logging later. This will be your only opportunity to do so."</p> <p>The default successful-message is "You may now use the Internet."</p> <p>notification-message-color: Defines the message color by selecting RGB (0,0,255), or type a <i>color_name</i> such as red, or enter the hex color format (#00FF00).</p>
show payment-service account-delivery	<p>Displays how the Zyxel Device provides dynamic guest account information after the user's online payment is done (<i>onscreen</i> or <i>sms</i>).</p>

Table 133 payment-service Commands (continued)

COMMAND	DESCRIPTION
show payment-service check payment-all-currency	Checks if the billing currency is different from the payment currency configured.
show payment-service activation	Displays if payment service is active.
show payment-service provider select	Displays the payment service provider selected.
show payment-service provider paypal	Displays account, currency, identity token, and payment gateway details of the PayPal payment service provider.
show payment-service page- customization	Displays whether customization of desktop online payment service is enabled.
show payment-service profile-page settings	Displays the message prompting payment service plan selection
show payment-service success-page settings	Displays the settings for messages for when a new account is created successfully.
show payment-service fail-page settings	Displays the message for if a desktop payment transaction fails.
show payment-service sms-page settings	Displays the SMS message in Desktop View when a new account is created.
show payment-service mobile-page- customization	Displays whether customization of mobile online payment service pages that displays after an unauthorized user clicks the link in the Web Configurator login screen to purchase access time, is enabled.
show payment-service mobile- profile-page settings	Displays the message prompting mobile payment service plan selection.
show payment-service mobile- success-page settings	Displays whether customization for mobile view messages when a new account is created successfully is enabled.
show payment-service mobile-fail- page settings	Displays the settings for messages if a mobile payment transaction fails.
show payment-service mobile-sms- page settings	Displays the SMS message in Mobile View when a new account is created.

The following table describes the sub-commands for the `payment-service` command.

Table 134 payment-service paypal Sub-commands

COMMAND	DESCRIPTION
payment-service provider paypal account e-mail	Configures an e-mail address for the PayPal account.  <i>e-mail</i> : type a valid e-mail address for this account
payment-service provider paypal no account	Removes the PayPal account.
payment-service provider paypal currency <i>paypal_currency</i>	Defines the currency in which payments are made  <i>paypal_currency</i> : Select the currency that PayPal supports. For example, <i>aud, cad, chf, czk, dkk, eur, gbp, hkd, huf, ils, jpy, mxn, nok, nzd, php, pln, sek, sgd, thb, twd, usd</i> .
payment-service provider paypal identity-token <i>paypal_token</i>	Defines the PayPal ID token.  <i>paypal_token</i> : Enter the ID token provided to you by PayPal after successfully applying for your PayPal account.
payment-service provider paypal no identity-token	Removes the PayPal ID token.

Table 134 payment-service paypal Sub-commands (continued)

COMMAND	DESCRIPTION
<pre>payment-service provider paypal gateway payment_gw_url</pre>	<p>Defines the PayPal gateway.</p> <p><i>payment_gw_url</i>: Enter the address of the PayPal gateway provided to you by PayPal after applying for your PayPal account.</p>
<pre>payment-service check paypal- currency</pre>	<p>Displays the currency in which PayPal payments are made.</p>

## 32.4 Printer Manager Overview

You can create dynamic guest accounts and print guest account information by pressing the button on an external statement printer, such as SP350E. Make sure that the printer is connected to the appropriate power and the Zyxel Device, and that there is printing paper in the printer. Refer to the printer's documentation for details.

## 32.5 Printer-manager Commands

This table lists the `printer-manager` commands. You must use the `configure` terminal command to enter the configuration mode before you can use these commands.

Table 135 printer-manager Commands

COMMAND	DESCRIPTION
<pre>[no] printer-manager activate</pre>	<p>Allows the Zyxel Device to manage and monitor the printer status.</p> <p>The <code>no</code> command disables printer management on the Zyxel Device.</p>
<pre>printer-manager discover</pre>	<p>Detects the printer(s) that is connected to the Zyxel Device and display the printer information.</p>
<pre>printer-manager button {a   b   c} profile_name</pre>	<p>Applies the specified billing profile to a button of the web-based account generator and/or the button on a connected statement printer</p>
<pre>[no] printer-manager encrypt activate</pre>	<p>Turns on data encryption. Data transmitted between the Zyxel Device and the printer will be encrypted with a secret key.</p> <p>The <code>no</code> command disables data encryption.</p>
<pre>printer-manager encrypt secret-key secret_key</pre>	<p>Sets a key for data encryption.</p> <p><i>secret_key</i>: four alphanumeric characters (A-Z, a-z, 0-9)</p>
<pre>printer-manager multi-printout &lt;1..3&gt;</pre>	<p>Sets how many copies of subscriber statements you want to print (1 is the default).</p>
<pre>printer-manager port &lt;1..65535&gt;</pre>	<p>Sets the number of port on which the Zyxel Device sends data to the printer for it to print.</p>
<pre>[no] printer-manager printer &lt;1..10&gt;</pre>	<p>Enters the <code>printer-manager printer</code> sub-command mode to configure a printer that can be managed by the Zyxel Device. See <a href="#">Table 132 on page 256</a> for the sub-commands.</p> <p>The <code>no</code> command removes the specified printer from the printer list.</p>
<pre>printer-manager printer append</pre>	<p>Enters the <code>printer-manager printer</code> sub-command mode to add a printer to the end of the printer list. See <a href="#">Table 132 on page 256</a> for the sub-commands.</p>

Table 135 printer-manager Commands (continued)

COMMAND	DESCRIPTION
<code>printer-manager printout-type {customized   default}</code>	Sets to use the default account printout format built into the Zyxel Device or use a custom account printout format.
<code>show printer-manager button</code>	Displays the name of billing profile that is applied to each button.
<code>show printer-manager discover-printer-status</code>	Displays information of the printer that is connected to and detected by the Zyxel Device.
<code>show printer-manager printer [&lt;1..10&gt;]</code>	Displays settings of all or the specified printer that can be managed by the Zyxel Device.
<code>show printer-manager printer-status</code>	Displays information about the printers that are connected and can be managed by the Zyxel Device.
<code>show printer-manager printerfw version</code>	Displays the version of the printer firmware currently uploaded to the Zyxel Device. The Zyxel Device automatically installs it in the connected printers to make sure the printers are upgraded to the same version.
<code>show printer-manager printout-type</code>	Displays the current account printout format.
<code>show printer-manager settings</code>	Displays the printer management settings.
<code>show printer-manager workableIP</code>	Displays the number and IP address(s) of printer(s) that can synchronize with the Zyxel Device successfully.

### 32.5.1 Printer-manager Printer Sub-commands

The following table describes the sub-commands for the `printer-manager printer` command.

Table 136 printer-manager printer Sub-commands

COMMAND	DESCRIPTION
<code>activate</code>	Enables the entry.
<code>deactivate</code>	Disables the entry.
<code>description <i>description</i></code>	Sets a descriptive name for the printer.
<code>printer-ip <i>ipv4_address</i></code>	Sets the IP address of the printer.

### 32.5.2 Printer-manager Command Example

This example adds a printer to the managed printer list and displays the printer settings.

```
Router# configure terminal
Router(config)# printer-manager printer 1
Router(printer-manager)# activate
Router(printer-manager)# description cafe
Router(printer-manager)# printer-ip 172.16.0.123
Router(printer-manager)# exit
Router(config)# show printer-manager printer
printer: 1
  activate: yes
  IPv4 address: 172.16.0.123
  description: cafe
Router(config)#
```

## 32.6 Free Time Overview

With Free Time, the Zyxel Device can create dynamic guest accounts that allow users to browse the Internet free of charge for a specified period of time.

## 32.7 Free-Time Commands

The following table lists the `free-time` commands. You must use the `configure terminal` command to enter the configuration mode before you can use these commands.

Table 137 free-time Commands

COMMAND	DESCRIPTION
[no] <code>free-time activate</code>	Turns on the free time feature to allow users to get a free account for Internet surfing during the specified time period.  The <code>no</code> command disables the free time feature.
[no] <code>free-time auto-login</code>	Allow users to log into their free account directly without having to enter their user name and password.  The <code>no</code> command requires users to enter their user name and password, and click login to access their free account.
[no] <code>free-time deliver-method onscreen</code>	Sets the Zyxel Device to display the user account information in the web screen.  The <code>no</code> command sets the Zyxel Device to not display the user account information in the web screen.
[no] <code>free-time deliver-method sms</code>	Sets the Zyxel Device to send account information in an SMS text message to the user's mobile device.  The <code>no</code> command sets the Zyxel Device to not send account information in an SMS text message to the user's mobile device.
[no] <code>free-time maximum-allowed-account &lt;1..2000&gt;</code>	Specifies the maximum number of the free user accounts that users can create. The Zyxel Device rejects prevents users from creating a free account after this limit is reached.  The <code>no</code> command resets the setting to its default value of 1000.
[no] <code>free-time maximum-register-number &lt;1..5&gt;</code>	Specifies the maximum number of the users that are allowed to log in for Internet access simultaneously with a free guest account before the time specified using the <code>free-time reset-register</code> command.  The <code>no</code> command resets the setting to its default value (1).
[no] <code>free-time reset-register hh:mm</code>	Sets the time in 24-hour format at which the new free time account is allowed to access the Internet.  The <code>no</code> command resets the setting to its default value (00:00).
[no] <code>free-time time-period time_period</code>	Sets the duration of time period (in minutes) for which the free time account is allowed to access the Internet.  <i>time_period</i> : x - y, where x and y depend on the Zyxel Device model.  The <code>no</code> command resets the setting to its default value (30).
<code>show free-time status</code>	Displays the free time settings.

## 32.8 Free-Time Commands Example

The following example enables the free time feature and sets the Zyxel Device to provide user account information in the web screen and also sent account information via SMS text messages. It then displays the free time settings.

```
Router# configure terminal
Router(config)# free-time activate
Router(config)# free-time deliver-method onscreen
Router(config)# free-time deliver-method sms
Router(config)# show free-time status
Activate: yes
Time Period: 30
Reset Time: 00:00
Maximum registration number before reset time: 1
Delivery Method: onscreen-sms
Router(config)#
```

## 32.9 IPnP Overview

IP Plug and Play (IPnP) allows a computer to access the Internet without changing the network settings (such as IP address and subnet mask) of the computer, even when the IP addresses of the computer and the Zyxel Device are not in the same subnet.

When you disable the IPnP feature, only computers with dynamic IP addresses or static IP addresses in the same subnet as the Zyxel Device's LAN IP address can connect to the Zyxel Device or access the Internet through the Zyxel Device.

The IPnP feature does not apply to a computer using either a dynamic IP address or a static IP address that is in the same subnet as the Zyxel Device's IP address.

Note: You must enable NAT to use the IPnP feature.

## 32.10 IPnP Commands

The following table lists the `ipnp` commands. You must use the `configure terminal` command to enter the configuration mode before you can use these commands.

Table 138 ipnp Commands

COMMAND	DESCRIPTION
[no] ip ipnp activate	Enables IPnP on the Zyxel Device. The <code>no</code> command disables IPnP.
ip ipnp config	Enters the IPnP sub-command mode to enable IPnP on specific internal interface(s).
[no] interface <i>interface_name</i>	Enables IPnP on a specific internal interface. The <code>no</code> command disables IPnP for the specified interface.



Table 138 ipnp Commands (continued)

COMMAND	DESCRIPTION
show ip ipnp activation	Displays whether IPnP is enabled on the Zyxel Device.
show ip ipnp interface	Displays whether IPnP is enabled on an interface.

## 32.11 IPnP Commands Example

The following example enables IPnP on the Zyxel Device and interface lan1. It also displays the IPnP settings.

```
Router# configure terminal
Router(config)# ip ipnp activate
Router(config)# ip ipnp config
Router(ipnp)# interface lan1
Router(ipnp)# exit
Router(config)# show ip ipnp activation
IPnP Status: yes
Router(config)# show ip ipnp interface
interface
=====
lan1
Router(config)#
```

## 32.12 Walled Garden Overview

A user must log in before the Zyxel Device allows the user's access to the Internet. However, with a walled garden, you can define one or more web site addresses that all users can access without logging in. These can be used for advertisements for example.

## 32.13 Walled Garden Commands

This table lists the walled-garden commands. You must use the `configure terminal` command to enter the configuration mode before you can use these commands.

Table 139 walled-garden Commands

COMMAND	DESCRIPTION
[no] walled-garden activate	Enables the walled garden feature. The no command disables the walled garden feature.
[no] walled-garden rule <1..50>	Creates a walled garden URL link entry (URLs that use the HTTP or HTTPS protocol) for web site that all users are allowed to access without logging in, and enters sub-command mode. See <a href="#">Section Table 140 on page 266</a> for the rule sub-commands.
walled-garden rule append	Creates a new walled garden URL entry at the end of the current list and enters sub-command mode. See <a href="#">Table 140 on page 266</a> for the sub-commands.

Table 139 walled-garden Commands (continued)

COMMAND	DESCRIPTION
walled-garden rule flush	Deletes all walled garden URL entries.
walled-garden rule insert <1..50>	Creates a new walled garden URL entry at the specified location, renumbers the other entries accordingly, and enters sub-command mode. See <a href="#">Table 140 on page 266</a> for the sub-commands.
walled-garden rule move <1..50> to <1..50>	Moves the specified walled garden URL entry to the specified location and renumbers the other entries accordingly.
walled-garden domain-ip rule <1..50>	Creates a walled garden web site link entry, which uses a (wildcard) domain name or an IP address for web site that all users are allowed to access without logging in, and enters sub-command mode. See <a href="#">Section Table 141 on page 267</a> for the rule sub-commands.
walled-garden domain-ip rule append	Creates a new walled garden domain name or IP address entry at the end of the current list and enters sub-command mode. See <a href="#">Table 141 on page 267</a> for the sub-commands.
walled-garden domain-ip rule flush	Deletes all walled garden domain name or an IP address entries.
show walled-garden activation	Displays whether the walled garden feature is enabled or not.
show walled-garden rule <1..50>	Displays settings of the specified walled garden URL entry.

### 32.13.1 walled-garden rule Sub-commands

The following table describes the sub-commands for several `walled-garden rule` commands. Note that not all rule commands use all the sub-commands listed here.

Table 140 walled-garden rule Sub-commands

COMMAND	DESCRIPTION
[no] activate	Enables this entry. The <code>no</code> command disables the entry.
[no] name <i>description</i>	Sets a descriptive name for the walled garden link to be displayed in the login screen. The <code>no</code> command clears the description.  <i>description:</i> You can use up to 31 alphanumeric characters (A-Z, a-z, 0-9) and underscores (_). Spaces are not allowed. The first character must be a letter.
[no] hidden	Sets the Zyxel Device to not display the web site link in the user login screen.  This is helpful if a user's access to a specific web site is required to stay connected but he or she does not need to visit that web site.  The <code>no</code> command displays the web site link in the user login screen.
[no] url <i>url</i>	Sets the URL or IP address of the web site. Use "http://" followed by up to 262 characters (0-9a-zA-Z;/?:@&=+\$\._!~*'()%). For example, <code>http://www.example.com</code> or <code>http://172.16.1.35</code> .  The <code>no</code> command removes the web site address.

## 32.13.2 walled-garden domain-ip rule Sub-commands

The following table describes the sub-commands for several `walled-garden domain-ip` rule commands. Note that not all rule commands use all the sub-commands listed here.

Table 141 walled-garden domain-ip rule Sub-commands

COMMAND	DESCRIPTION
[no] activate	Enables this entry. The <code>no</code> command disables the entry.
[no] name <i>description</i>	Sets a descriptive name for the walled garden link to be displayed in the login screen. The <code>no</code> command clears the description.  <i>description</i> : You can use up to 31 alphanumeric characters (A-Z, a-z, 0-9) and underscores (_). Spaces are not allowed. The first character must be a letter.
[no] type {domain ip}	Sets the rule type to be a domain name or an IPv4 IP address.
[no] domain-name <i>walled_garden_fqdn</i>	Sets a fully qualified name for the <code>domain</code> type rule.  <i>walled_garden_fqdn</i> : Type a valid fully qualified name for this rule.  The <code>no</code> command removes the fully qualified name.
[no] ip-address <w.x.y.z>/ <1..32>	Sets the IPv4 subnet in CIDR format for the <code>ip</code> type rule. For example, 192.168.1.0/32.  The <code>no</code> command removes the web site address.

## 32.13.3 Walled Garden Command Example

This example shows how to enable the walled garden feature and insert a walled garden link rule at position 1 of the checking order. This example also displays the rule settings. The link rule uses the following settings:

- Activate: yes
- Name: Example1
- URL: www.example.com

```
Router# configure terminal
Router(config)# walled-garden activate
Router(config)# walled-garden rule insert 1
Router(walled-garden)# activate
Router(walled-garden)# name Example1
Router(walled-garden)# url http://www.example.com
Router(walled-garden)# exit
Router(config)# show walled-garden
walled garden rule: 1
  active: yes
  url: http://www.example.com
  name: Example1
Router(config)#
```

## 32.14 Advertisement Overview

You can set the Zyxel Device to display an advertisement web page as the first web page whenever the user connects to the Internet.

## 32.15 Advertisement Commands

This table lists the advertisement commands. You must use the `configure terminal` command to enter the configuration mode before you can use these commands.

Table 142 advertisement Commands

COMMAND	DESCRIPTION
[no] advertisement activate	Enables the advertisement feature. The no command disables the advertisement feature.
advertisement flush	Deletes all advertisement rules.
[no] advertisement name <i>description url url</i>	Sets a descriptive name for the advertisement web page and enters the web site address to create a new rule. The no command removes the advertisement rule.  <i>description:</i> You can use up to 31 alphanumeric characters (A-Z, a-z, 0-9) and underscores (_). Spaces are not allowed. The first character must be a letter.  <i>url:</i> the URL or IP address of the web site. Use "http://" followed by up to 262 characters (0-9a-zA-Z/?:@&=+\$\._!*'()%). For example, http://www.example.com or http://172.16.1.35.
advertisement rename <i>description_old description_new</i>	Gives an existing rule a new name.
show advertisement	Displays settings of advertisement rule(s).
show advertisement activation	Displays whether the advertisement feature is enabled or not.

### 32.15.1 Advertisement Command Example

This example shows how to set an advertisement rule and displays the rule settings.

```
Router# configure terminal
Router(config)# advertisement activate
Router(config)# advertisement name example url http://www.example.com
Router(config)# show advertisement
advertisement rule: 1
  name: example
  url: http://www.example.com
Router(config)#
```

# CHAPTER 33

## IPSec VPN

This chapter explains how to set up and maintain IPSec VPNs in the Zyxel Device.

### 33.1 IPSec VPN Overview

A virtual private network (VPN) provides secure communications between sites without the expense of leased site-to-site lines. A secure VPN is a combination of tunneling, encryption, authentication, access control and auditing. It is used to transport traffic over the Internet or any insecure network that uses TCP/IP for communication.

Internet Protocol Security (IPSec) is a standards-based VPN that offers flexible solutions for secure data communications across a public network like the Internet. IPSec is built around a number of standardized cryptographic techniques to provide confidentiality, data integrity and authentication at the IP layer.

The following figure is one example of a VPN tunnel. Here local Zyxel Device **X** uses an IPSec VPN tunnel to remote (peer) Zyxel Device **Y** to connect the local (**A**) and remote (**B**) networks.

**Figure 25** VPN: Example

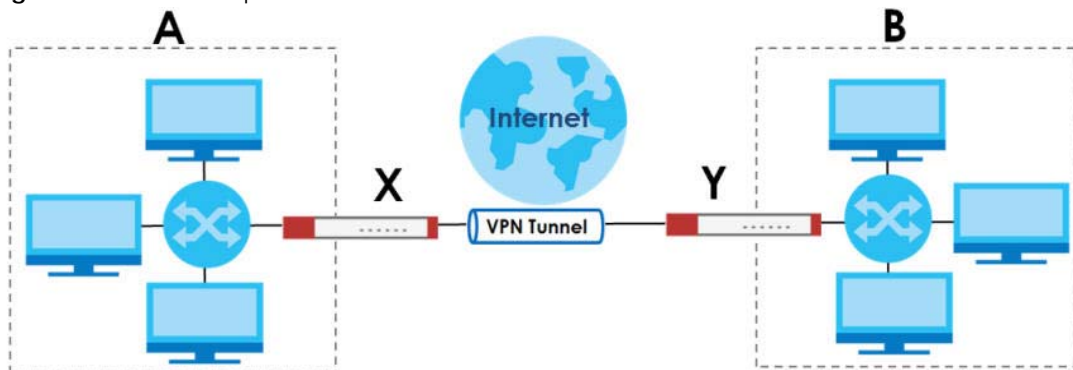

A VPN tunnel is usually established in two phases. Each phase establishes a security association (SA), a contract indicating what security parameters the Zyxel Device and the remote IPSec router will use. The first phase establishes an Internet Key Exchange (IKE) SA between the Zyxel Device and remote IPSec router. The second phase uses the IKE SA to securely establish an IPSec SA through which the Zyxel Device and remote IPSec router can send data between computers on the local network and remote network. This is illustrated in the following figure.

Figure 26 VPN: IKE SA and IPsec SA

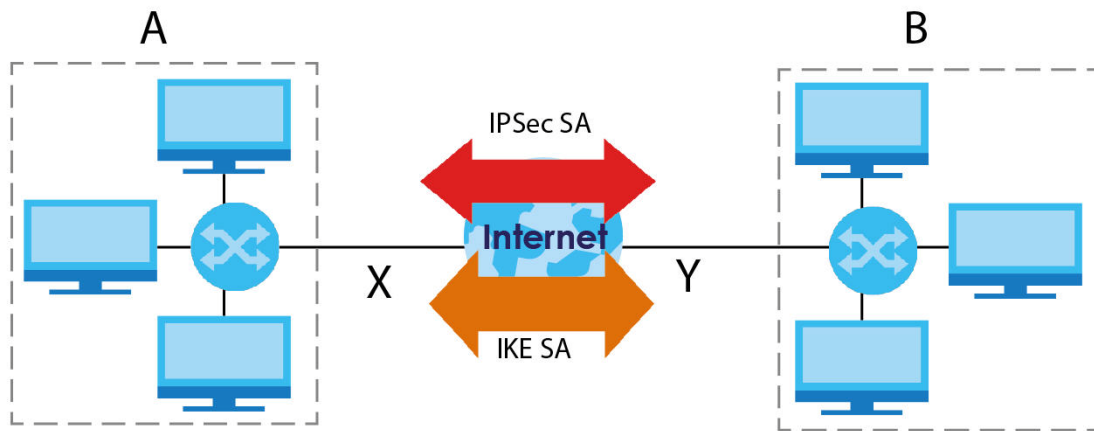

In this example, a computer in network **A** is exchanging data with a computer in network **B**. Inside networks **A** and **B**, the data is transmitted the same way data is normally transmitted in the networks. Between routers **X** and **Y**, the data is protected by tunneling, encryption, authentication, and other security features of the IPsec SA. The IPsec SA is secure because routers **X** and **Y** established the IKE SA first.

## 33.2 IPsec VPN Commands Summary

The following table describes the values required for many IPsec VPN commands. Other values are discussed with the corresponding commands.

Table 143 Input Values for IPsec VPN Commands

LABEL	DESCRIPTION
<i>profile_name</i>	The name of a VPN concentrator. You may use 1-31 alphanumeric characters, underscores(_), or dashes (-), but the first character cannot be a number. This value is case-sensitive.
<i>policy_name</i>	The name of an IKE SA. You may use 1-31 alphanumeric characters, underscores(_), or dashes (-), but the first character cannot be a number. This value is case-sensitive.
<i>map_name</i>	The name of an IPsec SA. You may use 1-31 alphanumeric characters, underscores(_), or dashes (-), but the first character cannot be a number. This value is case-sensitive.
<i>domain_name</i>	Fully-qualified domain name. You may use up to 254 alphanumeric characters, dashes (-), or periods (.), but the first character cannot be a period.
<i>e_mail</i>	An e-mail address. You can use up to 63 alphanumeric characters, underscores (_), dashes (-), or @ characters.
<i>distinguished_name</i>	A domain name. You can use up to 511 alphanumeric, characters, spaces, or .@=, _- characters.

Table 143 Input Values for IPsec VPN Commands (continued)

LABEL	DESCRIPTION
<i>sort_order</i>	Sort the list of currently connected SAs by one of the following classifications. algorithm encapsulation inbound name outbound policy timeout uptime
<i>auth_method</i>	The name of the authentication profile.

The following sections list the IPsec VPN commands.

### 33.2.1 IPv4 IKEv1 SA Commands

This table lists the commands for IKE SAs (VPN gateways).

Table 144 isakmp Commands: IKE SAs

COMMAND	DESCRIPTION
[no] <code>crypto boost-tcp</code>	Enhances TCP throughput traffic performance. This command must be applied on both local Zyxel Device and peer Zyxel Device.  The <code>no</code> command disables this feature.
<code>show crypto boost-tcp</code>	Displays if TCP throughput traffic performance is enhanced or not.
<code>show isakmp keepalive</code>	Displays the Dead Peer Detection period.
<code>show isakmp policy [policy_name]</code>	Shows the specified IKE SA or all IKE SAs.
[no] <code>isakmp policy policy_name</code>	Creates the specified IKE SA if necessary and enters sub-command mode. The <code>no</code> command deletes the specified IKE SA.
<code>activate</code> <code>deactivate</code>	Activates or deactivates the specified IKE SA.
<code>authentication {pre-share   rsa-sig   user-base-psk }</code>	Specifies whether to use a pre-shared key, a certificate, or a user-based pre-shared key for authentication.
<code>certificate certificate-name</code>	Sets the certificate that can be used for authentication.
[no] <code>dpd</code>	Enables Dead Peer Detection (DPD). The <code>no</code> command disables DPD.
<code>dpd-interval &lt;15..60&gt;</code>	Sets the Dead Peer Detection (DPD) period.
[no] <code>fall-back</code>	Set this to have the Zyxel Device reconnect to the primary address when it becomes available again and stop using the secondary connection, if the connection to the primary address goes down and the Zyxel Device changes to using the secondary connection.  Users will lose their VPN connection briefly while the Zyxel Device changes back to the primary connection. To use this, the peer device at the secondary address cannot be set to use a nailed-up VPN connection.

Table 144 isakmp Commands: IKE SAs (continued)

COMMAND	DESCRIPTION
<code>fall-back-check-interval</code> <60..86400>	Sets how often (in seconds) the Zyxel Device checks if the primary address is available.
<code>mode {main   aggressive}</code>	Sets the negotiating mode.
<code>transform-set isakmp-algo</code> [ <code>isakmp_algo</code> [ <code>isakmp_algo</code> ]]	Sets the encryption and authentication algorithms for each IKE SA proposal.  <i>isakmp_algo</i> : {des-md5   des-sha   3des-md5   3des-sha   aes128-md5   aes128-sha   aes192-md5   aes192-sha   aes256-md5   aes256-sha   aes256-sha256   aes256-sha512}
<code>lifetime</code> <180..3000000>	Sets the IKE SA life time to the specified value.
<code>group1</code> <code>group2</code> <code>group5</code> <code>group14</code>	Sets the DHx group to the specified group.
[no] <code>natt</code>	Enables NAT traversal. The <code>no</code> command disables NAT traversal.
<code>local-ip</code> { <code>ip</code> { <code>ip</code>   <code>domain_name</code> }   <code>interface</code> <code>interface_name</code> }	Sets the local gateway address to the specified IP address, domain name, or interface.
<code>peer-ip</code> { <code>ip</code>   <code>domain_name</code> } [ <code>ip</code>   <code>domain_name</code> ]	Sets the remote gateway address(es) to the specified IP address(es) or domain name(s).
<code>keystring</code> <code>pre_shared_key</code>	Sets the pre-shared key of up to 128 characters that can be used for authentication. The <code>pre_shared_key</code> can be: <ul style="list-style-type: none"> <li>Alphanumeric characters or ;   ` ~ ! @ # \$ % ^ &amp; * ( ) _ + \ { } ' : . / &lt; &gt; = - .</li> <li>Hexadecimal (0-9, A-F) characters, preceded by "0x".</li> </ul> The pre-shared key is case-sensitive.
<code>local-id type</code> { <code>ip</code> <code>ip</code>   <code>fqdn</code> <code>domain_name</code>   <code>mail</code> <code>e_mail</code>   <code>dn</code> <code>distinguished_name</code> }	Sets the local ID type and content to the specified IP address, domain name, or e-mail address.
<code>peer-id type</code> { <code>any</code>   <code>ip</code> <code>ip</code>   <code>fqdn</code> <code>domain_name</code>   <code>mail</code> <code>e_mail</code>   <code>dn</code> <code>distinguished_name</code> }	Sets the peer ID type and content to any value, the specified IP address, domain name, or e-mail address.
[no] <code>twofa-auth</code>	Enables two-factor authentication. The <code>no</code> command disables two-factor authentication.  See <a href="#">Section 56.4 on page 467</a> and <a href="#">Section 56.5 on page 471</a> for more information on configuring two-factor authentication settings.



Table 144 isakmp Commands: IKE SAs (continued)

COMMAND	DESCRIPTION
<pre>xauth type {server auth_method [user-id {username   any}]   client name username password password} [deactivate]</pre>	<p>Enables extended authentication and specifies whether the Zyxel Device is the server or client. If the Zyxel Device is the server, it also specifies the extended authentication method (<code>aaa authentication profile_name</code>); if the Zyxel Device is the client, it also specifies the username and password to provide to the remote IPsec router. The <code>deactivate</code> command disables extended authentication.</p> <p><i>auth_method</i>: The name of the authentication profile the VPN configuration provisioning service uses to authenticate users.</p> <p><i>user-id</i>: A user or user group allowed to use the IKE SA. <i>any</i> allows any user with a valid user account and password on the Zyxel Device to use the IKE SA.</p> <p><i>username</i>: You can use alphanumeric characters, underscores (<code>_</code>), and dashes (<code>-</code>), and it can be up to 31 characters long.</p> <p><i>password</i>: You can use most printable ASCII characters. You cannot use square brackets [<code>]</code>], double quotation marks (<code>"</code>), question marks (<code>?</code>), tabs or spaces. It can be up to 31 characters long.</p>
<pre>isakmp policy rename policy_name policy_name</pre>	<p>Renames the specified IKE SA (first <i>policy_name</i>) to the specified name (second <i>policy_name</i>).</p>

### 33.2.2 IPv4 IPsec SA Commands (except Manual Keys)

This table lists the commands for IPsec SAs, excluding manual keys (VPN connections using VPN gateways).

Table 145 crypto Commands: IPsec SAs

COMMAND	DESCRIPTION
<pre>[no] crypto ignore-df-bit</pre>	<p>Fragment packets larger than the MTU (Maximum Transmission Unit) that have the "don't fragment" bit in the header turned on. The <code>no</code> command has the Zyxel Device drop packets larger than the MTU that have the "don't fragment" bit in the header turned on.</p>
<pre>show crypto map [map_name]</pre>	<p>Shows the specified IPsec SA or all IPsec SAs.</p>
<pre>crypto map dial map_name</pre>	<p>Dials the specified IPsec SA manually. This command does not work for IPsec SAs using manual keys or for IPsec SAs where the remote gateway address is 0.0.0.0.</p>
<pre>[no] crypto map map_name</pre>	<p>Creates the specified IPsec SA if necessary and enters sub-command mode. The <code>no</code> command deletes the specified IPsec SA.</p>
<pre>crypto map rename map_name map_name</pre>	<p>Renames the specified IPsec SA (first <i>map_name</i>) to the specified name (second <i>map_name</i>).</p>
<pre>activate deactivate</pre>	<p>Activates or deactivates the specified IPsec SA.</p>

Table 145 crypto Commands: IPsec SAs (continued)

COMMAND	DESCRIPTION
<code>adjust-mss {auto   &lt;200..1500&gt;}</code>	Set a specific number of bytes for the Maximum Segment Size (MSS) meaning the largest amount of data in a single TCP segment or IP datagram for this VPN connection or use <code>auto</code> to have the ZyWALL automatically set it.
<code>ipsec-isakmp <i>policy_name</i></code>	Specifies the IKE SA for this IPsec SA and disables manual key.
<code>encapsulation {tunnel   transport}</code>	Sets the encapsulation mode.
<code>transform-set <i>crypto_algo_esp</i> [<i>crypto_algo_esp</i> [<i>crypto_algo_esp</i>]]</code>	Sets the active protocol to ESP and sets the encryption and authentication algorithms for each proposal.  <i>crypto_algo_esp</i> : <code>esp-null-md5   esp-null-sha   esp-null-sha256   esp-null-sha512   esp-des-md5   esp-des-sha   esp-des-sha256   esp-des-sha512   esp-3des-md5   esp-3des-sha   esp-3des-sha256   esp-3des-sha512   esp-aes128-md5   esp-aes128-sha   esp-aes128-sha256   esp-aes128-sha512   esp-aes192-md5   esp-aes192-sha   esp-aes192-sha256   esp-aes192-sha512   esp-aes256-md5   esp-aes256-sha   esp-aes256-sha256   esp-aes256-sha512</code>
<code>transform-set <i>crypto_algo_ah</i> [<i>crypto_algo_ah</i> [<i>crypto_algo_ah</i>]]</code>	Sets the active protocol to AH and sets the encryption and authentication algorithms for each proposal.  <i>crypto_algo_ah</i> : <code>ah-md5   ah-sha   ah-sha256   ah-sha512</code>
<code>scenario {site-to-site-static site-to-site-dynamic remote-access-server remote-access-client}</code>	Select the scenario that best describes your intended VPN connection.  <i>site-to-site</i> : The remote IPsec router has a static IP address or a domain name. This Zyxel Device can initiate the VPN tunnel.  <i>site-to-site-dynamic</i> : The remote IPsec router has a dynamic IP address. Only the remote IPsec router can initiate the VPN tunnel.  <i>remote-access-server</i> : Allow incoming connections from IPsec VPN clients. The clients have dynamic IP addresses and are also known as dial-in users. Only the clients can initiate the VPN tunnel.  <i>remote-access-client</i> : Connects to an IPsec server. This Zyxel Device is the client (dial-in user) and can initiate the VPN tunnel.  <i>vpn-tunnel-interface</i> : Sets up a VPN tunnel interface to bind with a VPN connection. The Zyxel Device can use the interface to do load balancing using a specific Trunk. The remote IPsec router should have a static IP address or a domain name.
<code>set security-association lifetime seconds &lt;180..3000000&gt;</code>	Sets the IPsec SA life time.
<code>set pfs {group1   group2   group5   none}</code>	Enables Perfect Forward Secrecy group.
<code>local-policy <i>address_name</i></code>	Sets the address object for the local policy (local network).
<code>remote-policy <i>address_name</i></code>	Sets the address object for the remote policy (remote network).

Table 145 crypto Commands: IPsec SAs (continued)

COMMAND	DESCRIPTION
[no] policy-enforcement	Drops traffic whose source and destination IP addresses do not match the local and remote policy. This makes the IPsec SA more secure. The <code>no</code> command allows traffic whose source and destination IP addresses do not match the local and remote policy.  Note: You must allow traffic whose source and destination IP addresses do not match the local and remote policy, if you want to use the IPsec SA in a VPN concentrator.
[no] nail-up	Automatically re-negotiates the SA as needed. The <code>no</code> command does not.
[no] replay-detection	Enables replay detection. The <code>no</code> command disables it.
[no] netbios-broadcast	Enables NetBIOS broadcasts through the IPsec SA. The <code>no</code> command disables NetBIOS broadcasts through the IPsec SA.
[no] out-snat activate	Enables out-bound traffic SNAT over IPsec. The <code>no</code> command disables out-bound traffic SNAT over IPsec.
out-snat source <i>address_name</i> destination <i>address_name</i> snat <i>address_name</i>	Configures out-bound traffic SNAT in the IPsec SA.
[no] in-snat activate	Enables in-bound traffic SNAT in the IPsec SA. The <code>no</code> command disables in-bound traffic SNAT in the IPsec SA.
in-snat source <i>address_name</i> destination <i>address_name</i> snat <i>address_name</i>	Configures in-bound traffic SNAT in the IPsec SA.
[no] in-dnat activate	Enables in-bound traffic DNAT in the IPsec SA. The <code>no</code> command disables in-bound traffic DNAT in the IPsec SA.
in-dnat delete <1..10>	Deletes the specified rule for in-bound traffic DNAT in the specified IPsec SA.
in-dnat move <1..10> to <1..10>	Moves the specified rule (first rule number) to the specified location (second rule number) for in-bound traffic DNAT.
in-dnat append protocol {all   tcp   udp} original-ip <i>address_name</i> <0..65535> <0..65535> mapped-ip <i>address_name</i> <0..65535> <0..65535>	Maps the specified IP address and port range (original-ip) to the specified IP address and port range (mapped-ip) and appends this rule to the end of the rule list for in-bound traffic DNAT.
in-dnat insert <1..10> protocol {all   tcp   udp} original-ip <i>address_name</i> <0..65535> <0..65535> mapped-ip <i>address_name</i> <0..65535> <0..65535>	Maps the specified IP address and port range (original-ip) to the specified IP address and port range (mapped-ip) and inserts this rule before the specified rule.
in-dnat <1..10> protocol {all   tcp   udp} original-ip <i>address_name</i> <0..65535> <0..65535> mapped-ip <i>address_name</i> <0..65535> <0..65535>	Creates or revises the specified rule and maps the specified IP address and port range (original-ip) to the specified IP address and port range (mapped-ip).
[no] configuration-payload-provide activate	Enables configuration payload in server role. The <code>no</code> command disables it.
configuration-payload-provide address- {}	Sets configuration payload address . The <code>no</code> command disables it

Table 145 crypto Commands: IPsec SAs (continued)

COMMAND	DESCRIPTION
[no] configuration-payload-provide {first-dns IPv6 second-dns IPv6}	Sets configuration payload address dns server. The no command disables it
[no] narrowed	Enables policy narrowed. The no command disables it.
[no] protocol gre	Enables GRE over IPsec to allow traffic using the Generic Routing Encapsulation (GRE) tunneling protocol through an IPsec tunnel. The no protocol command disables it.
mode-config activate	Allows the IPsec VPN client to receive an IP address, DNS and WINS information from the Zyxel Device when the scenario is Remote Access (Server Role) and VPN Gateway uses IKEv1. remote-access-server allows incoming connections from IPsec VPN clients with dynamic IP addresses.
mode-config address- profile_name	Sets the IP address to be included in the VPN setup data.  profile_name: an address or address group object
[no] mode-config {first-dns   second-dns}	Specifies the DNS server IP address to assign to the remote users. The second-dns server's IP address is checked if first-dns is unavailable. The no command removes the setting.

Table 145 crypto Commands: IPsec SAs (continued)

COMMAND	DESCRIPTION
<pre>[no] mode-config {first-wins   second-wins}</pre>	<p>Sets the IP address of the WINS (Windows Internet Naming Service) server that you want to send to the remote users. The WINS server keeps a mapping table of the computer names on your network and the IP addresses that they are currently using. The <code>second-wins</code> server's IP address is checked if <code>first-wins</code> is unavailable. The <code>no</code> command removes the setting.</p>
<pre>conn-check {ip address ip address / first-and-last} method {icmp   tcp} period &lt;5...3600&gt; timeout &lt;1...10&gt; fail-tolerance &lt;1...10&gt; action {log   no-log} probe-condition {all   any}</pre>	<p>Enables the IPsec VPN connection check. The Zyxel Device can regularly check the VPN connection to the gateway to specified to make sure it is still available.</p> <p><i>ip address</i>: Specifies one or two domain names or IP addresses for the connectivity check. You can use one IP address and one domain name. Separate them with a comma, for example, 1.1.1.1,www.zyxel.com.</p> <p><i>first-and-last</i>: Checks the connection to the first and last IP addresses in the connection's remote policy. Remote policy is the addresses of the devices behind the remote IPsec router. Make sure one of these is the peer gateway's LAN IP address.</p> <p><i>method</i>: Sets how the Zyxel Device checks the connection. The peer must be configured to respond to the method you select.</p> <p>Sets the method to <code>icmp</code> to have the Zyxel Device regularly ping the address you specify to make sure traffic can still go through the connection. You may need to configure the peer to respond to pings.</p> <p>Sets the method to <code>tcp</code> to have the Zyxel Device regularly perform a TCP handshake with the address you specify to make sure traffic can still go through the connection. You may need to configure the peer to accept the TCP connection.</p> <p><i>period</i>: Sets the number of seconds between connection check attempts.</p> <p><i>time-out</i>: Sets the number of seconds to wait for a response before the attempt is a failure.</p> <p><i>fail-tolerance</i>: Sets the number of consecutive failures allowed before the Zyxel Device disconnects the VPN tunnel. The Zyxel Device resumes using the first peer gateway address when the VPN connection passes the connectivity check.</p> <p><i>action</i>: Sets the action to <code>log</code> to have the Zyxel Device generate a log every time it checks this VPN.</p> <p>Sets the action to <code>no-log</code> to have the Zyxel Device take no action when it checks this VPN.</p> <p><i>probe-condition</i>: Sets the probe-condition to <code>any</code> if you want the check to pass when at least one of the domain names or IP addresses responds.</p> <p>Sets the probe-condition <code>all</code> if you want the check to pass only when both domain names or IP addresses respond.</p>

### 33.2.3 IPv4 IPsec SA Commands (for Manual Keys)

This table lists the additional commands for IPsec SAs using manual keys (VPN connections using manual keys).

Table 146 crypto map Commands: IPsec SAs (Manual Keys)

COMMAND	DESCRIPTION
<code>crypto map map_name</code>	
<pre> set session-key {ah &lt;256..4095&gt; auth_key   esp &lt;256..4095&gt; [cipher enc_key] authenticator auth_key} </pre>	<p>Sets the active protocol, SPI (&lt;256..4095&gt;), authentication key and encryption key (if any).</p> <p><i>auth_key</i>: You can use any alphanumeric characters or , ;   ~ ! @ # \$ % ^ &amp; * ( ) _ + \ { } ' : . / &lt; &gt; = - ". The length of the key depends on the algorithm.</p> <p>md5 - 16-20 characters</p> <p>sha - 20 characters</p> <p>sha256 - 32 characters</p> <p>sha512 - 64 characters</p> <p><i>enc_key</i>: You can use any alphanumeric characters or , ;   ~ ! @ # \$ % ^ &amp; * ( ) _ + \ { } ' : . / &lt; &gt; = - ". The length of the key depends on the algorithm.</p> <p>des - 8-32 characters</p> <p>3des - 24-32 characters</p> <p>aes128 - 16-32 characters</p> <p>aes192 - 24-32 characters</p> <p>aes256 - 32 characters</p> <p>If you want to enter the key in hexadecimal, type "0x" at the beginning of the key. For example, "0x0123456789ABCDEF" is in hexadecimal format; in "0123456789ABCDEF" is in ASCII format. If you use hexadecimal, you must enter twice as many characters.</p> <p>The Zyxel Device automatically ignores any characters above the minimum number of characters required by the algorithm. For example, if you enter 1234567890XYZ for a DES encryption key, the Zyxel Device only uses 12345678. The Zyxel Device still stores the longer key.</p>
<code>local-ip ip</code>	Sets the local gateway address to the specified IP address.
<code>peer-ip ip</code>	Sets the remote gateway address to the specified IP address.

### 33.2.4 VPN Concentrator Commands

This table lists the commands for the VPN concentrator.

Table 147 vpn-concentrator Commands: VPN Concentrator

COMMAND	DESCRIPTION
<code>show vpn-concentrator [profile_name]</code>	Shows the specified VPN concentrator or all VPN concentrators.
<code>[no] vpn-concentrator profile_name</code>	Creates the specified VPN concentrator if necessary and enters sub-command mode. The <code>no</code> command deletes the specified VPN concentrator.
<code>[no] crypto map_name</code>	Adds the specified IPsec SA to the specified VPN concentrator. The <code>no</code> command removes the specified IPsec SA from the specified VPN concentrator.
<code>vpn-concentrator rename profile_name profile_name</code>	Renames the specified VPN concentrator (first <i>profile_name</i> ) to the specified name (second <i>profile_name</i> ).

### 33.2.5 VPN Configuration Provisioning Commands

This table lists the commands for VPN configuration provisioning.

Table 148 vpn-configuration-provision Commands: VPN Configuration Provisioning

COMMAND	DESCRIPTION
<code>vpn-configuration-provision rule { append   conf_index   insert conf_index }</code>	Enters the VPN configuration provisioning sub-command mode to add or edit a rule.  <i>conf_index</i> : The index number of a VPN configuration provisioning rule, 1 to the Zyxel Device's maximum number of VPN connection rules.
<code>[no] activate</code>	Turns the VPN configuration provisioning rule on or off.
<code>crypto map_name</code>	Specifies the name of the IPsec VPN connection ( <i>map_name</i> ) to bind to this VPN configuration provisioning rule's user or group.
<code>user username</code>	Specifies a user or group of users allowed to use the Zyxel Device IPsec VPN client to retrieve the associated VPN rule settings. A user may belong to a number of groups. If VPN configuration provisioning rules are configured for different groups, the Zyxel Device will allow VPN rule setting retrieval based on the first match found. Admin or limited-admin users are not allowed.
<code>no user</code>	Removes the VPN configuration provisioning rule's user or user group configuration. In other words, any users can match the rule. In the GUI "any" will display in the <b>Allowed User</b> field.
<code>[no] ul-bandwidth-limit &lt;1...1048576&gt;</code>	Sets the maximum bandwidth for uploading traffic from IPsec VPN clients over IPsec VPN tunnels.  This feature is available for Zyxel subscription-based SecuExtender IPsec VPN clients with Window version 5.6.80.007 or later or macOS version 1.2.0.7 or later.
<code>exit</code>	Leaves sub-command mode.
<code>vpn-configuration-provision rule { delete conf_index   move conf_index to conf_index }</code>	Deletes or moves the specified VPN configuration provisioning rule.
<code>[no] vpn-configuration-provision activate</code>	Turns the VPN configuration provisioning service on or off.

Table 148 vpn-configuration-provision Commands: VPN Configuration Provisioning

COMMAND	DESCRIPTION
<code>vpn-configuration-provision port &lt;1...65535&gt;</code>	<p>Sets a new port between 1024 to 65535 that is not in use by other services.</p> <p>This change the default port that IPsec VPN clients use to retrieve VPN rule settings from the Zyxel Device. The default is 443 which is already in use for remote management by default. If you change the default IPsec VPN port on the Zyxel Device, make sure to make the same change to the Zyxel IPsec VPN client.</p>
<code>no vpn-configuration-provision port</code>	Sets the VPN configuration provisioning port back to default.
<code>show vpn-configuration-provision port</code>	Displays the current VPN configuration provisioning port.
<code>vpn-configuration-provision authentication <i>auth_method</i></code>	Sets the authentication method the VPN configuration provisioning service uses to authenticate users.
<code>show vpn-configuration-provision activation</code>	Displays whether or not the VPN configuration provisioning service is activated.
<code>show vpn-configuration-provision authentication</code>	Displays the authentication method the VPN configuration provisioning service uses to authenticate users.
<code>show vpn-configuration-provision rules</code>	Displays the settings of the configured VPN configuration provisioning rules.
<code>show vcp allowed users</code>	Displays available users who can be configured as allowed users (using <code>user username</code> ) of a VPN Configuration Provision (VCP) rule.
<code>show vcp allowed crypto map</code>	Displays IPv4 VPN Connection rules which can be used in a VPN Configuration Provision (VCP) rule. Nothing displays if no suitable rules are available.
<code>show vcp allowed crypto map6</code>	Displays IPv6 VPN Connection rules which can be used in a VPN Configuration Provision (VCP) rule. Nothing displays if no suitable rules are available.
<code>[no] vpn-configuration-provision iosfilter</code>	<p>Enables over-the-air VPN provisioning for mobile Apple (iOS) devices.</p> <p>The Apple (iOS) user must log into the Zyxel Device web configurator using a Safari browser to be authenticated. The user can then set up a VPN connection by visiting a link in the Safari browser to install an XML VPN configuration file. The VPN rule for the Apple (iOS) device must be configured first. Each VPN rule must have a separate link. Types of VPN supported are:</p> <ul style="list-style-type: none"> <li>• L2TP</li> <li>• IKEv1 Cisco VPN</li> <li>• IKEv2 (for iOS 9.3 and later)</li> </ul> <p>The <code>no</code> command disables over-the-air VPN provisioning for mobile Apple (iOS) devices using a Safari browser.</p>
<code>show vpn-configuration-provision iosfilter</code>	Displays if over-the-air VPN provisioning for mobile Apple (iOS) devices is enabled on the Zyxel Device.



## 33.2.6 SA Monitor Commands

This table lists the commands for the SA monitor.

Table 149 sa Commands: SA Monitor

COMMAND	DESCRIPTION
<pre>show sa monitor [{begin &lt;1..1000&gt;}   {end &lt;1..1000&gt;}   {crypto-map regexp}   {policy regexp}   {rsort sort_order}   {sort sort_order}]</pre>	<p>Displays the current IPsec SAs and the status of each one. You can specify a range of SA entries to display. You can also control the sort order of the display and search by VPN connection or (local or remote) policy.</p> <p><i>regexp</i>: A keyword or regular expression. Use up to 30 alphanumeric and <code>_+-.()!\$*^?: {}[]&lt;&gt;/</code> characters.</p> <p>A question mark (?) lets a single character in the VPN connection or policy name vary. For example, use "a?c" (without the quotation marks) to specify abc, acc and so on.</p> <p>Wildcards (*) let multiple VPN connection or policy names match the pattern. For example, use "*abc" (without the quotation marks) to specify any VPN connection or policy name that ends with "abc". A VPN connection named "testabc" would match. There could be any number (of any type) of characters in front of the "abc" at the end and the VPN connection or policy name would still match. A VPN connection or policy name named "testacc" for example would not match.</p> <p>A * in the middle of a VPN connection or policy name has the Zyxel Device check the beginning and end and ignore the middle. For example, with "abc*123", any VPN connection or policy name starting with "abc" and ending in "123" matches, no matter how many characters are in between.</p> <p>The whole VPN connection or policy name has to match if you do not use a question mark or asterisk.</p> <p>See <a href="#">Table 143 on page 270</a> for other parameter description.</p>
show isakmp sa	Displays current IKE SA and the status of each one.
no sa spi <i>spi</i>	Deletes the SA specified by the SPI. <i>spi</i> : 2-8 hexadecimal (0-9, A-F) characters
no sa tunnel-name <i>map_name</i>	Deletes the specified IPsec SA.
show sa counter	Displays the IPsec VPN tunnels that are currently established.
show vpn-counters	Displays VPN traffic statistics.

## 33.2.7 IPv4 IKEv2 SA Commands

This table lists the commands for the IPv4 IKEv2 SA.

Table 150 sa Commands: IPv4 IKEv2

COMMAND	DESCRIPTION
show ikev2 policy [ <i>policy_name</i> ]	Shows the specified IKEv2 SA or all IKEv2 SAs.
[no] ikev2 policy <i>policy_name</i>	Creates the specified IKEv2 SA if necessary and enters sub-command mode. The no command deletes the specified IKEv2 SA.
activate deactivate	Activates or deactivates the specified IKEv2 SA.

Table 150 sa Commands: IPv4 IKEv2 (continued)

COMMAND	DESCRIPTION
authentication {pre-share   rsa-sig}	Specifies whether to use a pre-shared key or a certificate for authentication
certificate certificate-name	Sets the certificate that can be used for authentication.
[no] fall-back	Set this to have the Zyxel Device reconnect to the primary address when it becomes available again and stop using the secondary connection, if the connection to the primary address goes down and the Zyxel Device changes to using the secondary connection. Users will lose their VPN connection briefly while the Zyxel Device changes back to the primary connection. To use this, the peer device at the secondary address cannot be set to use a nailed-up VPN connection.
fall-back-check-interval <60..86400>	Sets how often (in seconds) the Zyxel Device checks if the primary address is available.
transform-set isakmp-algo [isakmp_algo [isakmp_algo]]	Sets the encryption and authentication algorithms for each IKEv2 SA proposal.  isakmp_algo: {des-md5   des-sha   3des-md5   3des-sha   aes128-md5   aes128-sha   aes192-md5   aes192-sha   aes256-md5   aes256-sha   aes256-sha256   aes256-sha512}
lifetime <180..3000000>	Sets the IKEv2 SA life time to the specified value.
group1 group2 group5 group14 group15 group16 group17 group18	Sets the DH group to the specified group.
local-ip {ip {ip   domain_name}   interface interface_name}	Sets the local gateway address to the specified IP address, domain name, or interface.
peer-ip {ip   domain_name} [ip   domain_name]	Sets the remote gateway address(es) to the specified IP address(es) or domain name(s).
keystring pre_shared_key	Sets the pre-shared key of up to 128 characters that can be used for authentication. The pre_shared_key can be: <ul style="list-style-type: none"> <li>Alphanumeric characters or ;   ` ~ ! @ # \$ % ^ &amp; * ( ) _ + \ { } ' : / &lt; &gt; = - .</li> <li>Hexadecimal (0-9, A-F) characters, preceded by "0x".</li> </ul> The pre-shared key is case-sensitive.
local-id type {ip ip   fqdn domain_name   mail e_mail   dn distinguished_name}	Sets the local ID type and content to the specified IP address, domain name, or e-mail address.
peer-id type {any   ip ip   fqdn domain_name   mail e_mail   dn distinguished_name}	Sets the peer ID type and content to any value, the specified IP address, domain name, or e-mail address.
eap auth_method AUTH_METHOD	Sets auth method for EAP. Default value is Mschapv2.

Table 150 sa Commands: IPv4 IKEv2 (continued)

COMMAND	DESCRIPTION
[no] eap type {server AAA_method user-id {name any}  client name username {password PASSWORD  encrypted-password PASSWORD}}	<p>Enables extended authentication and specifies whether the ZyWALL/ USG is the server or client. If the Zyxel Device is the server, it also specifies the AAA authentication method (aaa authentication profile_name); if the Zyxel Device is the client, it also specifies the username and password to provide to the remote IPsec router. The no command disables extended authentication.</p> <ul style="list-style-type: none"> <li>username: You can use alphanumeric characters, underscores (_), and dashes (-), and it can be up to 31 characters long.</li> <li>password: You can use most printable ASCII characters. You cannot use square brackets [ ], double quotation marks (*), question marks (?), tabs or spaces. It can be up to 31 characters long.</li> </ul>
ikev2 policy rename policy_name policy_name	Renames the specified IKEv2 SA (first policy_name) to the specified name (second policy_name).
[no] twofa-auth	Enables two-factor authentication. The no command disables two-factor authentication.

### 33.2.8 IPv6 IKEv2 SA Commands

This table lists the commands for the IPv4 IKEv2 SA.

Table 151 sa Commands: IPv6 IKEv2

COMMAND	DESCRIPTION
show ikev2 policy6 [policy_name]	Shows the specified IKEv2 SA or all IKEv2 SAs.
[no] ikev2 policy6 policy_name	Creates the specified IKEv2 SA if necessary and enters sub-command mode. The no command deletes the specified IKEv2 SA.
activate deactivate	Activates or deactivates the specified IKEv2 SA.
authentication {pre-share   rsa-sig}	Specifies whether to use a pre-shared key or a certificate for authentication
certificate certificate-name	Sets the certificate that can be used for authentication.
[no] fall-back	Set this to have the Zyxel Device reconnect to the primary address when it becomes available again and stop using the secondary connection, if the connection to the primary address goes down and the Zyxel Device changes to using the secondary connection. Users will lose their VPN connection briefly while the Zyxel Device changes back to the primary connection. To use this, the peer device at the secondary address cannot be set to use a nailed-up VPN connection.
fall-back-check-interval <60..86400>	Sets how often (in seconds) the Zyxel Device checks if the primary address is available.
transform-set isakmp-algo [isakmp_algo [isakmp_algo]]	<p>Sets the encryption and authentication algorithms for each IKEv2 SA proposal.</p> <p>isakmp_algo: {des-md5   des-sha   3des-md5   3des-sha   aes128-md5   aes128-sha   aes192-md5   aes192-sha   aes256-md5   aes256-sha   aes256-sha256   aes256-sha512}</p>
lifetime <180..3000000>	Sets the IKEv2 SA life time to the specified value.
group1 group2 group5	Sets the DH group to the specified group.

Table 151 sa Commands: IPv6 IKEv2 (continued)

COMMAND	DESCRIPTION
<code>local-ip {ip IPv6}</code>	Sets the local gateway address to the specified IP address.
<code>peer-ip {ip IPv6}</code>	Sets the remote gateway address(es) to the specified IP address(es).
<code>keystring</code> <code>pre_shared_key</code>	Sets the pre-shared key of up to 128 characters that can be used for authentication. The <code>pre_shared_key</code> can be: <ul style="list-style-type: none"> <li>Alphanumeric characters or <code>.; `~!@#\$\$%^&amp;*()_+ \{}':./&lt;&gt;=-</code>.</li> <li>Hexadecimal (0-9, A-F) characters, preceded by "0x".</li> </ul> The pre-shared key is case-sensitive.
<code>local-id type {ip IPv6   fqdn domain_name   mail e_mail   dn distinguished_name}</code>	Sets the local ID type and content to the specified IP address, domain name, or e-mail address.
<code>peer-id type {any   ip IPv6   fqdn domain_name   mail e_mail   dn distinguished_name}</code>	Sets the peer ID type and content to any value, the specified IP address, domain name, or e-mail address.
<code>eap auth_method</code> <code>auth_method</code>	Sets auth method for EAP. Default value is <code>Mschapv2</code> .
<code>[no] eap type {server auth_method user-id {name any}  client name username {password PASSWORD  encrypted-password password}</code>	Enables extended authentication and specifies whether the ZyWALL/ USG is the server or client. If the Zyxel Device is the server, it also specifies the AAA authentication method ( <code>aaa authentication profile_name</code> ); if the Zyxel Device is the client, it also specifies the username and password to provide to the remote IPsec router. The <code>no</code> command disables extended authentication. <ul style="list-style-type: none"> <li><code>username</code>: You can use alphanumeric characters, underscores (<code>_</code>), and dashes (<code>-</code>), and it can be up to 31 characters long.</li> <li><code>password</code>: You can use most printable ASCII characters. You cannot use square brackets [<code>]</code>], double quotation marks (<code>"</code>), question marks (<code>?</code>), tabs or spaces. It can be up to 31 characters long.</li> </ul>
<code>ikev2 policy rename policy_name policy_name</code>	Renames the specified IKEv2 SA (first <code>policy_name</code> ) to the specified name (second <code>policy_name</code> ).
<code>[no] twofa-auth</code>	Enables two-factor authentication. The <code>no</code> command disables two-factor authentication.

### 33.2.9 IPv6 IPsec SA Commands

This table lists the commands for IPv6 IPsec SAs.

Table 152 crypto Commands: IPv6 IPsec SAs

COMMAND	DESCRIPTION
<code>show crypto map6 [map_name]</code>	Shows the specified IPsec SA or all IPsec SAs.
<code>crypto map6 dial map_name</code>	Dials the specified IPsec SA manually. This command does not work for IPsec SAs using manual keys or for IPsec SAs where the remote gateway address is 0.0.0.0.
<code>[no] crypto map map_name</code>	Creates the specified IPsec SA if necessary and enters sub-command mode. The <code>no</code> command deletes the specified IPsec SA.
<code>crypto map rename map_name map_name</code>	Renames the specified IPsec SA (first <code>map_name</code> ) to the specified name (second <code>map_name</code> ).
<code>crypto map map_name</code>	

Table 152 crypto Commands: IPv6 IPsec SAs (continued)

COMMAND	DESCRIPTION
activate deactivate	Activates or deactivates the specified IPsec SA.
adjust-mss {auto   <200..1500>}	Set a specific number of bytes for the Maximum Segment Size (MSS) meaning the largest amount of data in a single TCP segment or IP datagram for this VPN connection or use <code>auto</code> to have the ZyWALL automatically set it.
ipsec-isakmp <i>policy_name</i>	Specifies the IKE SA for this IPsec SA and disables manual key.
encapsulation {tunnel   transport}	Sets the encapsulation mode.
transform-set <i>crypto_algo_esp</i> [ <i>crypto_algo_esp</i> [ <i>crypto_algo_esp</i> ]]	Sets the active protocol to ESP and sets the encryption and authentication algorithms for each proposal.  <i>crypto_algo_esp</i> : esp-null-md5   esp-null-sha   esp-null-sha256   esp-null-sha512   esp-des-md5   esp-des-sha   esp-des-sha256   esp-des-sha512   esp-3des-md5   esp-3des-sha   esp-3des-sha256   esp-3des-sha512   esp-aes128-md5   esp-aes128-sha   esp-aes128-sha256   esp-aes128-sha512   esp-aes192-md5   esp-aes192-sha   esp-aes192-sha256   esp-aes192-sha512   esp-aes256-md5   esp-aes256-sha   esp-aes256-sha256   esp-aes256-sha512
transform-set <i>crypto_algo_ah</i> [ <i>crypto_algo_ah</i> [ <i>crypto_algo_ah</i> ]]	Sets the active protocol to AH and sets the encryption and authentication algorithms for each proposal.  <i>crypto_algo_ah</i> : ah-md5   ah-sha   ah-sha256   ah-sha512
scenario {site-to-site-static site-to-site-dynamic remote-access-server remote-access-client}	Select the scenario that best describes your intended VPN connection.  <i>site-to-site</i> : The remote IPsec router has a static IP address or a domain name. This Zykel Device can initiate the VPN tunnel.  <i>site-to-site-dynamic</i> : The remote IPsec router has a dynamic IP address. Only the remote IPsec router can initiate the VPN tunnel.  <i>remote-access-server</i> : Allow incoming connections from IPsec VPN clients. The clients have dynamic IP addresses and are also known as dial-in users. Only the clients can initiate the VPN tunnel.  <i>remote-access-client</i> : Choose this to connect to an IPsec server. This Zykel Device is the client (dial-in user) and can initiate the VPN tunnel.
set security-association lifetime seconds <180..3000000>	Sets the IPsec SA life time.
set pfs {group1   group2   group5   none}	Enables Perfect Forward Secrecy group.
local-policy <i>address_name</i>	Sets the address object for the local policy (local network).
remote-policy <i>address_name</i>	Sets the address object for the remote policy (remote network).

Table 152 crypto Commands: IPv6 IPsec SAs (continued)

COMMAND	DESCRIPTION
[no] policy-enforcement	Drops traffic whose source and destination IP addresses do not match the local and remote policy. This makes the IPsec SA more secure. The <b>no</b> command allows traffic whose source and destination IP addresses do not match the local and remote policy.  Note: You must allow traffic whose source and destination IP addresses do not match the local and remote policy, if you want to use the IPsec SA in a VPN concentrator.
[no] nail-up	Automatically re-negotiates the SA as needed. The <b>no</b> command does not.
[no] replay-detection	Enables replay detection. The <b>no</b> command disables it.
[no] configuration-payload-provide activate	Enables configuration payload in server role. The <b>no</b> command disables it.
configuration-payload-provide address- {}	Sets configuration payload address . The <b>no</b> command disables it
[no] configuration-payload-provide {first-dns IPv6 second-dns IPv6}	Sets configuration payload address dns server. The <b>no</b> command disables it
[no] narrowed	Enables policy narrowed. The <b>no</b> command disables it

### 33.2.10 IPv6 VPN Concentrator Commands

This table lists the commands for the IPv6 VPN concentrator.

Table 153 vpn-concentrator Commands: VPN Concentrator

COMMAND	DESCRIPTION
show vpn-concentrator6 [profile_name]	Shows the specified IPv6 VPN concentrator or all IPv6 VPN concentrators.
[no] vpn-concentrator6 profile_name	Creates the specified IPv6 VPN concentrator if necessary and enters sub-command mode. The <b>no</b> command deletes the specified IPv6 VPN concentrator.
[no] crypto map_name	Adds the specified IPsec SA to the specified IPv6 VPN concentrator. The <b>no</b> command removes the specified IPsec SA from the specified IPv6 VPN concentrator.
vpn-concentrator6 rename profile_name profile_name	Renames the specified IPv6 VPN concentrator (first profile_name) to the specified name (second profile_name).

# CHAPTER 34

## SSL VPN

This chapter shows you how to set up secure SSL VPN access for remote user login.

### 34.1 SSL Access Policy

An SSL access policy allows the Zyxel Device to perform the following tasks:

- limit user access to specific applications or files on the network.
- allow user access to specific networks.
- assign private IP addresses and provide DNS/WINS server information to remote users to access internal networks.

#### 34.1.1 SSL Application Objects

SSL application objects specify an application type and server that users are allowed to access through an SSL tunnel. See [Chapter 60 on page 487](#) for how to configure SSL application objects.

#### 34.1.2 SSL Access Policy Limitations

You cannot delete an object that is used by an SSL access policy. To delete the object, you must first unassociate the object from the SSL access policy.

### 34.2 SSL VPN Commands

The following table describes the values required for some SSL VPN commands. Other values are discussed with the corresponding commands.

Table 154 Input Values for SSL VPN Commands

LABEL	DESCRIPTION
<i>profile_name</i>	The descriptive name of an SSL VPN access policy. You may use up to 31 characters ("a-z", "A-Z", "0-9") with no spaces allowed.
<i>address_object</i>	The name of an IP address (group) object. You may use 1-31 alphanumeric characters, underscores(_), or dashes (-), but the first character cannot be a number. This value is case-sensitive.
<i>application_object</i>	The name of an SSL application object. You may use up to 31 characters ("0-9", "a-z", "A-Z", "-", "_"). No spaces are allowed.
<i>user_name</i>	The name of a user (group). You may use 1-31 alphanumeric characters, underscores(_), or dashes (-), but the first character cannot be a number. This value is case-sensitive.

The following sections list the SSL VPN commands.

### 34.2.1 SSL VPN Commands

This table lists the commands for SSL VPN. You must use the `configure terminal` command to enter the configuration mode before you can use these commands.

Table 155 SSL VPN Commands

COMMAND	DESCRIPTION
<code>sslvpn login message &lt;description&gt;</code>	Sets the login message that users see after logging into the Zyxel Device using SSL VPN.
<code>sslvpn login-domain-1 &lt;domain name&gt;</code>	
<code>no sslvpn login-domain-1</code>	
<code>sslvpn login-domain-2 &lt;domain name&gt;</code>	
<code>no sslvpn login-domain-2</code>	
<code>sslvpn login-port &lt;1..65535&gt;</code>	Sets the SSL VPN server port of the Zyxel Device for full tunnel mode SLL VPN access.  Leave this field to default settings unless it conflicts with another interface.
<code>no sslvpn login-port</code>	Resets the SSL VPN server port of the Zyxel Device back to its default setting.
<code>show sslvpn login-port</code>	Displays the SSL VPN server port of the Zyxel Device.
<code>sslvpn logout message &lt;description&gt;</code>	Sets the login message that users see after logging out of the Zyxel Device using SSL VPN.
<code>sslvpn logout-defer-time &lt;2..10&gt;</code>	
<code>show sslvpn policy [profile_name]</code>	Displays the settings of the specified SSL VPN access policy.
<code>show ssl-vpn network-extension local-ip</code>	Displays the IP address that-t the Zyxel Device uses in setting up the SSL VPN.
<code>show sslvpn monitor</code>	Displays a list of the users who are currently logged into the VPN SSL client portal.
<code>sslvpn network-extension local-ip ip</code>	Sets the IP address that the Zyxel Device uses in setting up the SSL VPN.
<code>sslvpn policy {profile_name   profile_name append   profile_name insert &lt;1..16&gt;}</code>	Enters the SSL VPN sub-command mode to add or edit an SSL VPN access policy.
<code>[no] activate</code>	Turns the SSL VPN access policy on or off.
<code>[no] application application_object</code>	Adds the SSL application object to the SSL VPN access policy.
<code>[no] description description</code>	Adds information about the SSL VPN access policy. Use up to 60 characters ("0-9", "a-z", "A-Z", "-" and "_").



Table 155 SSL VPN Commands

COMMAND	DESCRIPTION
[no] network-extension {activate   ip- <i>address_object</i>   1st-dns { <i>address_object</i>   <i>ip</i> }   2nd-dns { <i>address_object</i>   <i>ip</i> }   1st-wins { <i>address_object</i>   <i>ip</i> }   2nd-wins { <i>address_object</i>   <i>ip</i> }   network <i>address_object</i> }	Use this to configure for a VPN tunnel between the authenticated users and the internal network. This allows the users to access the resources on the network as if they were on the same local network.  ip-: specify the name of the of IP addresses to assign to the user computers for the VPN connection.  Specify the names of the DNS or WINS servers to assign to the remote users. This allows them to access devices on the local network using domain names instead of IP addresses.  network: specify a network users can access.
[no] network-extension traffic-enforcement	Forces all SSL VPN client traffic to be sent through the SSL VPN tunnel. The no command disables this setting.
[no] network-extension netbios-broadcast	Allows netbios broadcast packets to pass through the SSL VPN tunnel.
[no] user <i>user_name</i>	Specifies the user or user group that can use the SSL VPN access policy.
sslvpn policy move <1..16> to <1..16>	Moves the specified SSL VPN access policy to the number that you specified.
sslvpn no connection username <i>user_name</i>	Terminates the user's SSL VPN connection and deletes corresponding session information from the Zyxel Device.
no sslvpn policy <i>profile_name</i>	Deletes the specified SSL VPN access policy.
sslvpn policy rename <i>profile_name</i> <i>profile_name</i>	Renames the specified SSL VPN access policy.
sslvpn update-interval <1..300>	
show workspace application	Displays the SSLVPN resources available to each user when logged into SSLVPN.
show workspace cifs	Displays the shared folders available to each user when logged into SSLVPN.

## 34.2.2 Setting an SSL VPN Rule Tutorial

Here is an example SSL VPN configuration. The SSL VPN rule defines:

- Only users using the "tester" account can use the SSL VPN.
- The Zyxel Device will assign an IP address from 192.168.100.1 to 192.168.100.10 (defined in object "IP-") to the computers which match the rule's criteria.
- The Zyxel Device will assign two DNS server settings (172.16.1.1 and 172.16.1.2 defined in objects DNS1 and DNS2) to the computers which match the rule's criteria.
- The SSL VPN users are allowed to access the Zyxel Device's local network, 172.16.10.0/24 (defined in object "Network1").

- 1 First of all, configure 10.1.1.254/24 for the IP address of interface ge2 which is an external interface for public SSL VPN to access. Configure 172.16.10.254/24 for the IP address of interface ge3 which is an internal network.

```

Router(config)# interface ge2
Router(config-if-ge)# ip address 10.1.1.254 255.255.255.0
Router(config-if-ge)# exit
Router(config)# interface ge3
Router(config-if-ge)# ip address 172.16.10.254 255.255.255.0
Router(config-if-ge)# exit

```

- 2 Create four address objects for the SSL VPN DHCP , DNS servers and the local network for SSL VPN authenticated users to access.

```

Router(config)# address-object IP- 192.168.100.1-192.168.100.10
Router(config)# address-object DNS1 172.16.5.1
Router(config)# address-object DNS2 172.16.5.2
Router(config)# address-object NETWORK1 172.16.10.0/24

```

- 3 Create the SSL VPN user account named tester with password 1234.

```

Router(config)# username tester password 1234 user-type user

```

- 4 Create an SSL VPN rule named SSL\_VPN\_TEST. Enable it and apply objects you just created.

```

Router(config)# sslvpn policy SSL_VPN_TEST
Router(policy SSL_VPN_TEST)# activate
Router(policy SSL_VPN_TEST)# user tester
Router(policy SSL_VPN_TEST)# network-extension activate
Router(policy SSL_VPN_TEST)# network-extension ip- IP-
Router(policy SSL_VPN_TEST)# network-extension 1st-dns DNS1
Router(policy SSL_VPN_TEST)# network-extension 2nd-dns DNS2
Router(policy SSL_VPN_TEST)# network-extension network NETWORK1

Router(policy SSL_VPN_TEST)# exit

```

- 5 Displays the SSL VPN rule settings.

```

Router(config)# show sslvpn policy SSL_VPN_TEST
index: 1
  active: yes
  name: SSL_VPN_TEST
  description:
  user: tester
  ssl application: none
  network extension: yes
  traffic enforcement: no
  netbios broadcast: no
  ip : IP-
  dns server 1: DNS1
  dns server 2: DNS2
  wins server 1: none
  wins server 2: none
  network: NETWORK1

  reference count: 0

```

# CHAPTER 35

## L2TP VPN

This chapter explains how to set up and maintain L2TP VPNs in the Zyxel Device.

### 35.1 L2TP VPN Overview

L2TP VPN lets remote users use the L2TP and IPSec client software included with their computers' operating systems to securely connect to the network behind the Zyxel Device. The remote users do not need their own IPSec gateways or VPN client software.

**Figure 27** L2TP VPN Overview

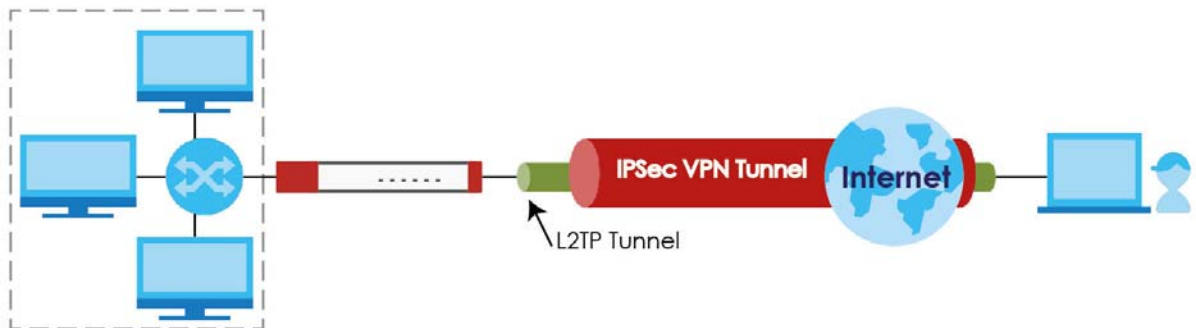

The Layer 2 Tunneling Protocol (L2TP) works at layer 2 (the data link layer) to tunnel network traffic between two peers over another network (like the Internet). In L2TP VPN, an IPSec VPN tunnel is established first (see [Chapter 33 on page 269](#) for information on IPSec) and then an L2TP tunnel is built inside it.

Note: At the time of writing the L2TP remote user must have a public IP address in order for L2TP VPN to work (the remote user cannot be behind a NAT router or a firewall).

### 35.2 IPSec Configuration

You must configure an IPSec VPN connection for L2TP VPN to use (see [Chapter 33 on page 269](#) for details). The IPSec VPN connection must:

- Be enabled.
- Use transport mode.
- Not be a manual key VPN connection.
- Use **Pre-Shared Key** authentication.

- Use a VPN gateway with the **Secure Gateway** set to **0.0.0.0** if you need to allow L2TP VPN clients to connect from more than one IP address.

### 35.2.1 Using the Default L2TP VPN Connection

**Default\_L2TP\_VPN\_Connection** is pre-configured to be convenient to use for L2TP VPN. If you use it, edit the following.

Configure the local and remote policies as follows.

- For the **Local Policy**, create an address object that uses host type and contains the **My Address** IP address that you configured in the **Default\_L2TP\_VPN\_GW**. Use this address object in the local policy.
- For the **Remote Policy**, create an address object that uses host type and an IP address of 0.0.0.0. Use this address object in the remote policy.

You must also edit the **Default\_L2TP\_VPN\_GW** gateway entry.

- Configure the **My Address** setting according to your requirements.
- Replace the default **Pre-Shared Key**.

## 35.3 LAN Policy Route

You must configure a policy route to let VPN users access resources on a network behind the Zyxel Device.

- Set the policy route's **Source Address** to the address object that you want to allow the remote users to access (**LAN\_SUBNET** in the following figure).
- Set the **Destination Address** to the IP address that the Zyxel Device assigns to the remote users (**L2TP\_** in the following figure).

**Figure 28** Policy Route for L2TP VPN

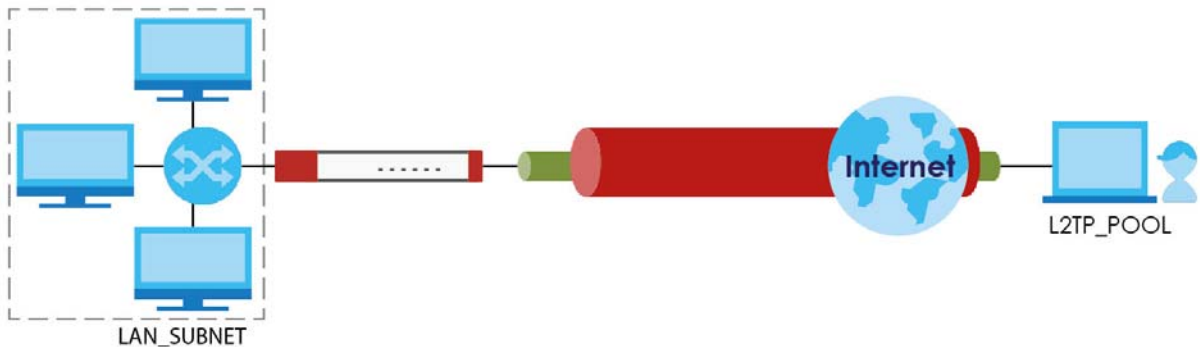

## 35.4 WAN Policy Route

You must configure a policy route with SNAT to let VPN users send traffic out through the WAN interface, for example to the Internet.

In firmware 5.0 and later, the Zyxel Device has a default policy route that forwards traffic from the VPN interface to the WAN and applies SNAT. This default policy route is applied to all VPN profiles in the zone VPN\_To\_WAN\_SNAT. VPN\_To\_WAN\_SNAT is a hidden zone and does not appear in the Web Configurator or when listing zones in the CLI.

Note: The Web Configurator automatically adds a VPN profile to zone VPN\_To\_WAN\_SNAT when you enable setting "Allow Traffic Through WAN Zone". In the CLI, you must add each VPN profiles to the VPN\_To\_WAN\_SNAT zone manually.

## 35.5 L2TP VPN Commands

The following table describes the values required for some L2TP VPN commands. Other values are discussed with the corresponding commands.

Table 156 Input Values for L2TP VPN Commands

LABEL	DESCRIPTION
<i>address_object</i>	The name of an IP address (group) object. You may use 1-31 alphanumeric characters, underscores(_), or dashes (-), but the first character cannot be a number. This value is case-sensitive.
<i>interface_name</i>	The name of the interface.  Ethernet interface: For some Zyxel Device models, use <i>gex</i> , $x = 1 - N$ , where $N$ equals the highest numbered Ethernet interface for your Zyxel Device model.  For other Zyxel Device models, use a name such as <i>wan1</i> , <i>wan2</i> , <i>opt</i> , <i>lan1</i> , or <i>dmz</i> .  VLAN interface: <i>vlanx</i> , $x = 0 - 4094$  bridge interface: <i>brx</i> , $x = 0 - N$ , where $N$ depends on the number of bridge interfaces your Zyxel Device model supports.
<i>ppp_interface</i>	PPPoE/PPTP interface: <i>pppx</i> , $x = 0 - N$ , where $N$ depends on the number of PPPoE/PPTP interfaces your Zyxel Device model supports.
<i>map_name</i>	The name of an IPSec SA. You may use 1-31 alphanumeric characters, underscores(_), or dashes (-), but the first character cannot be a number. This value is case-sensitive.
<i>user_name</i>	The name of a user (group). You may use 1-31 alphanumeric characters, underscores(_), or dashes (-), but the first character cannot be a number. This value is case-sensitive.
<i>domain_name</i>	Fully-qualified domain name. You may use up to 254 alphanumeric characters, dashes (-), or periods (.), but the first character cannot be a period.
<i>profile_name</i>	The name of an L2TP VPN account. You may use 1-31 alphanumeric characters, underscores(_), or dashes (-), but the first character cannot be a number. This value is case-sensitive.

The following sections list the L2TP VPN commands.

## 35.5.1 L2TP VPN Commands

This table lists the commands for L2TP VPN. You must use the `configure terminal` command to enter the configuration mode before you can use these commands.

Table 157 L2TP VPN Commands

COMMAND	DESCRIPTION
<code>l2tp-over-ipsec recover default-ipsec-policy</code>	If the default L2TP IPsec policy has been deleted, use this command to recreate it (with the default settings).
<code>[no] l2tp-over-ipsec activate;</code>	Turns L2TP VPN on. The <code>no</code> command turns it off.
<code>l2tp-over-ipsec crypto map_name</code>	Specifies the IPsec VPN connection the Zyxel Device uses for L2TP VPN. It must meet the requirements listed in <a href="#">Section 35.2 on page 291</a> .  Note: Modifying this VPN connection (or the VPN gateway that it uses) disconnects any existing L2TP VPN sessions.
<code>l2tp-over-ipsec address-object</code>	Specifies the address object that defines the of IP addresses that the Zyxel Device uses to assign to the L2TP VPN clients.
<code>l2tp-over-ipsec authentication authentication profile_name</code>	Specifies how the Zyxel Device authenticates a remote user before allowing access to the L2TP VPN tunnel.  The authentication method has the Zyxel Device check a user's user name and password against the Zyxel Device's local database, a remote LDAP, RADIUS, a Active Directory server, or more than one of these.
<code>certificate cert_name</code>	Select the certificate to use to identify the Zyxel Device for L2TP VPN connections. The certificate is used with the EAP, PEAP, and MSCHAPv2 authentication protocols. The certificate must already be configured.
<code>[no] l2tp-over-ipsec user user_name</code>	Specifies the user or user group that can use the L2TP VPN tunnel. If you do not configure this, any user with a valid account and password on the Zyxel Device to log in. The <code>no</code> command removes the user name setting.
<code>[no] l2tp-over-ipsec keepalive-timer &lt;1..180&gt;</code>	The Zyxel Device sends a Hello message after waiting this long without receiving any traffic from the remote user. The Zyxel Device disconnects the VPN tunnel if the remote user does not respond. The <code>no</code> command returns the default setting.
<code>[no] l2tp-over-ipsec first-dns-server {ip   interface_name} {1st-dns 2nd-dns 3rd-dns}   {ppp_interface}{1st-dns 2nd-dns}}</code>	Specifies the first DNS server IP address to assign to the remote users. You can specify a static IP address, or a DNS server that an interface received from its DHCP server. The <code>no</code> command removes the setting.
<code>[no] l2tp-over-ipsec second-dns-server {ip   interface_name} {1st-dns 2nd-dns 3rd-dns}   {ppp_interface}{1st-dns 2nd-dns}}</code>	Specifies the second DNS server IP address to assign to the remote users. You can specify a static IP address, or a DNS server that an interface received from its DHCP server. The <code>no</code> command removes the setting.
<code>[no] l2tp-over-ipsec first-wins-server ip</code>	Specifies the first WINS server IP address to assign to the remote users. The <code>no</code> command removes the setting.
<code>[no] l2tp-over-ipsec second-wins-server ip</code>	Specifies the second WINS server IP address to assign to the remote users. The <code>no</code> command removes the setting.
<code>no l2tp-over-ipsec session tunnel-id &lt;0..65535&gt;</code>	Deletes the specified L2TP VPN tunnel.

Table 157 L2TP VPN Commands

COMMAND	DESCRIPTION
show l2tp-over-ipsec	Displays the L2TP VPN settings.
show l2tp-over-ipsec session	Displays current L2TP VPN sessions.

## 35.5.2 L2TP Account Commands

This table lists the commands to create, remove, display and bind L2TP VPN accounts. You must use the `configure terminal` command to enter the configuration mode before you can use these commands.

Table 158 L2TP VPN Commands

COMMAND	DESCRIPTION
[no] account l2tp <i>profile_name</i>	Creates an L2TP account and enters sub-command mode.
authentication {chap   chap-pap   mschap   mschap-v2   pap}	Selects how the Zyxel Device authenticates a remote user before allowing access to the L2TP VPN tunnel. PAP (Password Authentication Protocol) is more readily available than CHAP (Challenge Handshake Authentication Protocol), but CHAP is more secure than PAP. <ul style="list-style-type: none"> <li>chap-pap - Your Zyxel Device accepts either CHAP or PAP when requested by this remote node.</li> <li>chap - Your Zyxel Device accepts CHAP only.</li> <li>pap - Your Zyxel Device accepts PAP only.</li> <li>mschap - Your Zyxel Device accepts MSCHAP only.</li> <li>mschap-v2 - Your Zyxel Device accepts MSCHAP-V2 only.</li> </ul>
encrypted-password <i>ciphertext</i>	Sets the password to encrypt L2TP traffic. <i>ciphertext</i> : The encryption password.
idle <0..360>	Specifies the number of seconds (0 to 360) that must elapse without traffic before the Zyxel Device automatically disconnects the L2TP tunnel. 0 (zero) means the timeout is disabled.
password <i>isp_account_password</i>	Sets the password given by the ISP for this account. <i>isp_account_password</i> : Password as given by ISP.
server { <i>domain_name</i>   <i>w.x.y.z</i> }	Specifies the fully-qualified domain name ( <i>domain_name</i> ) or IP address for the ISP account.
user <i>isp_account_username</i>	Displays the activity log for the specified user. <i>isp_account_username</i> : User name as given by ISP.
show account l2tp [ <i>profile_name</i> ]	Displays above details of all L2TP accounts or the one specified.
Interface <i>interface_name</i>	Specifies a PPP interface (see <a href="#">Section 16.2 on page 115</a> ) and enters that interface sub-command mode to bind an L2TP account to it.
account <i>profile_name</i>	Specifies the L2TP account to bind to this interface.
local-address <i>w.x.y.z</i>	Specifies the IP address of this interface.
Interface disconnect	Disconnects the L2TP tunnel on this interface.
Interface dial wan1_ppp	Connects the L2TP tunnel on this interface.
show interface ppp	Displays details of each PPP interface connection.

## 35.6 L2TP VPN Examples

This example uses the following settings in creating a basic L2TP VPN tunnel. See the Web Configurator User's Guide for how to configure L2TP in remote user computers using Windows XP and Windows 2000.

**Figure 29** L2TP VPN Example

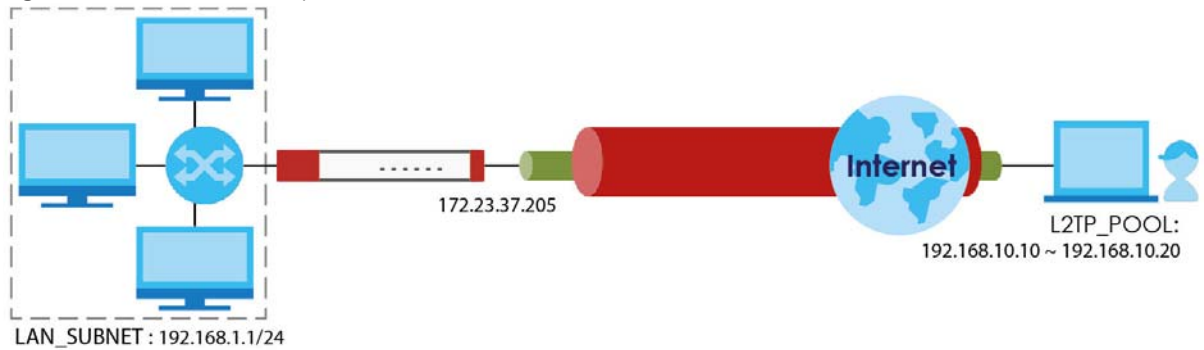

- The Zyxel Device has a static IP address of 172.23.37.205 for the ge3 interface.
- The remote user has a dynamic public IP address and connects through the Internet.
- You configure an IP address object named **L2TP\_** to assign the remote users IP addresses from 192.168.10.10 to 192.168.10.20 for use in the L2TP VPN tunnel.
- The VPN rule allows the remote user to access the **LAN\_SUBNET** which covers the 192.168.1.1/24 subnet.

### 35.6.1 Configuring the Default L2TP VPN Gateway Example

The following commands configure the **Default\_L2TP\_VPN\_GW** entry.

- Configure the **My Address** setting. This example uses interface ge3 with static IP address 172.23.37.205.
- Configure the **Pre-Shared Key**. This example uses "top-secret".

```
Router(config)# isakmp policy Default_L2TP_VPN_GW
Router(config-isakmp Default_L2TP_VPN_GW)# local-ip interface ge3
Router(config-isakmp Default_L2TP_VPN_GW)# authentication pre-share
Router(config-isakmp Default_L2TP_VPN_GW)# keystring top-secret
Router(config-isakmp Default_L2TP_VPN_GW)# activate
Router(config-isakmp Default_L2TP_VPN_GW)# exit
Router(config)#
```

### 35.6.2 Configuring the Default L2TP VPN Connection Example

The following commands configure the **Default\_L2TP\_VPN\_Connection** entry.

Enforce and configure the local and remote policies.

- For the **Local Policy**, create an address object that uses host type and contains the **My Address** IP address that you configured in the **Default\_L2TP\_VPN\_GW**. The address object in this example uses IP address 172.23.37.205 and is named **L2TP\_IFACE**.



- For the **Remote Policy**, create an address object that uses host type and an IP address of 0.0.0.0. It is named **L2TP\_HOST** in this example.

```
Router(config)# crypto map Default_L2TP_VPN_Connection
Router(config-crypto Default_L2TP_VPN_Connection)# policy-enforcement
Router(config-crypto Default_L2TP_VPN_Connection)# local-policy L2TP_IFACE
Router(config-crypto Default_L2TP_VPN_Connection)# remote-policy L2TP_HOST
Router(config-crypto Default_L2TP_VPN_Connection)# activate
Router(config-crypto Default_L2TP_VPN_Connection)# exit
Router(config)#
```

### 35.6.3 Configuring the L2TP VPN Settings Example

The following commands configure and display the L2TP VPN settings.

- Set it to use the **Default\_L2TP\_VPN\_Connection** VPN connection.
- Configure an IP address for the range of 192.168.10.10 to 192.168.10.20. In this example it is already created and called **L2TP\_**.
- This example uses the default authentication method (the Zyxel Device's local user data base).
- Select a user or group of users that can use the tunnel. Here a user account named **L2TP-test** has been created.
- The other settings are left to the defaults in this example.
- Enable the connection.

```
Router(config)# l2tp-over-ipsec crypto Default_L2TP_VPN_Connection
Router(config)# l2tp-over-ipsec L2TP_
Router(config)# l2tp-over-ipsec authentication default
Router(config)# l2tp-over-ipsec user L2TP-test
Router(config)# l2tp-over-ipsec activate
Router(config)# show l2tp-over-ipsec
L2TP over IPSec:
  activate           : yes
  crypto             : Default_L2TP_VPN_Connection
  address            : L2TP_
  authentication     : default
  user               : L2TP-test
  keepalive timer    : 60
  first dns server   : aux 1st-dns
  second dns server  : aux 1st-dns
  first wins server  :
  second wins server:
```

### 35.6.4 Configuring the LAN Policy Route for L2TP Example

The following commands configure and display the policy route for the L2TP VPN connection entry.

- Set the policy route's **Source Address** to the address object that you want to allow the remote users to access (**LAN\_SUBNET** in this example).
- Set the **Destination Address** to the IP address that the Zyxel Device assigns to the remote users (**L2TP\_** in this example).
- Set the next hop to be the **Default\_L2TP\_VPN\_Connection** tunnel.

- Enable the policy route.

```

Router(config)# policy 3
Router(policy-route)# source LAN_SUBNET
Router(policy-route)# destination L2TP_
Router(policy-route)# service any
Router(policy-route)# next-hop tunnel
Default_L2TP_VPN_ConnectionRouter(policy-route)# no deactivate
Router(policy-route)# exit
Router(config)# show policy-route 3
index: 3
  active: yes
  description: WIZ_VPN
  user: any
  schedule: none
  interface: ge1
  tunnel: none
  sslvpn: none
  source: PC_SUBNET
  destination: L2TP_
  service: any
  nexthop type: Tunnel
  nexthop: Default_L2TP_VPN_Connection
  bandwidth: 0
  bandwidth priority: 0
  maximize bandwidth usage: no
  SNAT: none
  amount of port trigger: 0

```

### 35.6.5 Configuring the WAN Policy Route for L2TP Example

Firmware 5.0 or later: The following commands configure the L2TP profile so that VPN clients to access the Internet through the WAN when connected to the Zyxel Device.

- Check that the default zone VPN\_To\_WAN\_SNAT exists.
- Add the L2TP VPN profile to the VPN\_To\_WAN\_SNAT zone.

```

Router# show zone VPN_To_WAN_SNAT
No. Type                               Member
=====
Router# configure terminal
Router(config)# zone VPN_To_WAN_SNAT
Router(zone)# crypto WIZ_VPN

```

# CHAPTER 36

## Bandwidth Management

### 36.1 Bandwidth Management Overview

Bandwidth management provides a convenient way to manage the use of various services on the network. It manages general protocols (for example, HTTP and FTP) and applies traffic prioritization to enhance the performance of delay-sensitive applications like voice and video.

#### 36.1.1 BWM Type

The Zyxel Device supports two types of bandwidth management: **shared**, **per-user** and **per-source-ip**.

The **shared** BWM type is selected by default in a bandwidth management rule. All users to which the rule is applied need to share the bandwidth configured in the rule. If the BWM type is set to **per-user** in a rule, every user that matches the rule can use up to the configured bandwidth by his/her own. Set the BWM type set to **per-source-ip** in a rule, when you want to set the maximum bandwidth for traffic from an individual source IP address.

### 36.2 Bandwidth Management Commands

The following table lists the `bwm` commands. You must use the `configure terminal` command to enter the configuration mode before you can use these commands.

Table 159 bwm Commands

COMMAND	DESCRIPTION
<code>bwm &lt;1..127&gt;</code>	Enters the <code>config-bwm</code> sub-command mode to configure a bandwidth management policy. See <a href="#">Table 160 on page 300</a> for the sub-commands.
<code>[no] bwm activate</code>	Enables bandwidth management on the Zyxel Device. The <code>no</code> command disabled bandwidth management.
<code>bwm append</code>	Enters the <code>config-bwm</code> sub-command mode to add a policy to the end of the policy list. See <a href="#">Table 160 on page 300</a> for the sub-commands.
<code>bwm default inbound priority &lt;1..7&gt;</code>	Specifies a number between 1 and 7 to set the priority for incoming traffic that matches the default policy. The smaller the number, the higher the priority. Traffic with a higher priority is given bandwidth before traffic with a lower priority.
<code>bwm default outbound priority &lt;1..7&gt;</code>	Specifies a number between 1 and 7 to set the priority for outgoing traffic that matches the default policy.
<code>bwm delete &lt;1..127&gt;</code>	Removes a policy.

Table 159 bwm Commands (continued)

COMMAND	DESCRIPTION
[no] bwm highest sip bandwidth priority	Maximizes the throughput of SIP traffic to improve SIP-based VoIP call sound quality. This has the Zyxel Device immediately send SIP traffic upon identifying it. When this option is enabled the Zyxel Device ignores any other application patrol rules for SIP traffic (so there is no bandwidth control for SIP traffic) and does not record SIP traffic bandwidth usage statistics.  The [no] command clears this setting.
bwm insert <1..127>	Enters the <code>config-bwm</code> sub-command mode to add a policy before the specified policy number. See <a href="#">Table 160 on page 300</a> for the sub-commands.
bwm <1..127>	Enters the <code>config-bwm</code> sub-command mode to create a bandwidth management policy. See <a href="#">Table 160 on page 300</a> for the sub-commands.
bwm modify <1..127>	Enters the <code>config-bwm</code> sub-command mode to edit a bandwidth management policy. See <a href="#">Table 160 on page 300</a> for the sub-commands.
bwm move <1..127> to <1..127>	Moves a policy to the number that you specified.
show bwm activation	Displays whether bandwidth management is enabled.
show bwm all	Displays all bandwidth management policies.
show bwm applications list	Displays all applications supported by bandwidth management.
show bwm default	Displays the default bandwidth management policy.
show bwm highest sip bandwidth priority	Displays whether the Zyxel Device is set maximize the throughput of SIP traffic to improve SIP-based VoIP call sound quality.

## 36.2.1 Bandwidth Sub-Commands

The following table describes the sub-commands for several `bwm` commands.

Table 160 bwm Sub-commands

COMMAND	DESCRIPTION
[no] activate	Enables a policy. The <code>no</code> command disables the policy.
[no] description <i>description</i>	Sets a descriptive name (up to 60 printable ASCII characters) for a policy.  The <code>no</code> command removes the descriptive name from the policy.
[no] destination <i>address_object</i>	Sets the destination IP address or address group for whom this policy applies.  The <code>no</code> command resets the destination IP address(es) to the default ( <i>any</i> ). <i>any</i> means all IP addresses.
[no] dscp {<0..63>   any   class {af11   af12   af13   af21   af22   af23   af31   af32   af33   af41   af42   af43   cs0   cs1   cs2   cs3   cs4   cs5   cs6   cs7   default   wmm_be0   wmm_be24   wmm_bk16   wmm_bk8   wmm_vi32   wmm_vi40   wmm_vo48   wmm_vo56}}	Specifies a DSCP code point value or sets an AF class or QoS access class of incoming or outgoing packets to which this policy applies.  <i>any</i> means all DSCP value or no DSCP marker.  The <code>no</code> command resets the DSCP code to the default ( <i>any</i> ).

Table 160 bwm Sub-commands (continued)

COMMAND	DESCRIPTION
[no] inbound ceiling {<0..1048576>   maximize-bandwidth-usage}	<p>Sets the maximum bandwidth allowed for incoming traffic or enables maximize bandwidth usage to let the traffic matching this policy "borrow" any unused bandwidth on the incoming interface.</p> <p>The no command resets the inbound maximum bandwidth to the default (0).</p>
[no] inbound guarantee-bandwidth <0..1048576> priority <1..7>	<p>Sets how much inbound bandwidth, in kilobits per second, this policy allows the traffic to use and also sets a number between 1 and 7 to set the priority for traffic that matches this policy. The smaller the number, the higher the priority.</p> <p>Inbound refers to the traffic the Zyxel Device sends to a connection's initiator.</p> <p>The no command resets the inbound guarantee bandwidth to the default (0).</p>
[no] inbound-dscp-mark {<0..63>   class {af11   af12   af13   af21   af22   af23   af31   af32   af33   af41   af42   af43   cs0   cs1   cs2   cs3   cs4   cs5   cs6   cs7   default   wmm_be0   wmm_be24   wmm_bk16   wmm_bk8   wmm_vi32   wmm_vi40   wmm_vo48   wmm_vo56}}	<p>Sets the DSCP value to apply to the incoming packets that match this policy.</p> <p>default: to have the Zyxel Device set the DSCP value of the packets to 0.</p> <p>The no command resets the incoming DSCP code to the default (preserve) and have the Zyxel Device keep the packets' original DSCP value.</p>
[no] incoming-interface {interface interface_name   trunk group_name}	<p>Sets the source interface of the traffic to which this policy applies.</p> <p><i>interface_name</i>: The name of the interface. This depends on the Zyxel Device model. See <a href="#">Table 49 on page 115</a> for detailed information about the interface name.</p> <p><i>group_name</i>: A descriptive name for the trunk. The name cannot start with a number. This value is case-sensitive.</p> <p>The no command resets the incoming interface to the default (any).</p>
[no] log [alert]	<p>Sets the Zyxel Device to generate a log (and alert) for packets that match the policy.</p> <p>The no command sets the Zyxel Device to not generate a log and alert for packets that match the policy.</p>
[no] outbound ceiling {<0..1048576>   maximize-bandwidth-usage}	<p>Sets the maximum bandwidth allowed for outgoing traffic or enables maximize bandwidth usage to let the traffic matching this policy "borrow" any unused bandwidth on the out-going interface.</p> <p>The no command resets the outbound maximum bandwidth to the default (0).</p>
[no] outbound guarantee-bandwidth <0..1048576> priority <1..7>	<p>Sets how much outbound bandwidth, in kilobits per second, this policy allows the traffic to use and also sets a number between 1 and 7 to set the priority for traffic that matches this policy. The smaller the number, the higher the priority.</p> <p>Outbound refers to the traffic the UAG sends out from a connection's initiator.</p> <p>The no command resets the outbound guarantee bandwidth to the default (0).</p>

Table 160 bwm Sub-commands (continued)

COMMAND	DESCRIPTION
[no] outbound-dscp-mark {<0..63>   class {af11   af12   af13   af21   af22   af23   af31   af32   af33   af41   af42   af43   cs0   cs1   cs2   cs3   cs4   cs5   cs6   cs7   default   wmm_be0   wmm_be24   wmm_bk16   wmm_bk8   wmm_vi32   wmm_vi40   wmm_vo48   wmm_vo56}}	<p>Sets the DSCP value to apply to the outgoing packets that match this policy.</p> <p>default: to have the Zyxel Device set the DSCP value of the packets to 0.</p> <p>The no command resets the outgoing DSCP code to the default (preserve) and have the Zyxel Device keep the packets' original DSCP value.</p>
[no] outgoing-interface {interface interface_name   trunk group_name}	<p>Sets the destination interface of the traffic to which this policy applies.</p> <p><i>interface_name</i>: The name of the interface. This depends on the Zyxel Device model. See <a href="#">Table 49 on page 115</a> for detailed information about the interface name.</p> <p><i>group_name</i>: A descriptive name for the trunk. The name cannot start with a number. This value is case-sensitive.</p> <p>The no command resets the outgoing interface to the default (any).</p>
[no] schedule schedule_object	<p>Specifies a schedule that defines when the policy applies.</p> <p>The no command resets the schedule to the default (none) to make the policy always effective.</p>
[no] service application-group app_name	<p>Specifies an Application Patrol service to identify the type pf traffic to which this policy applies.</p> <p>The no command resets the acation to the default (any).</p>
[no] service service-object {service_name   any}	<p>Specifies a service or service group to identify the type of traffic to which this policy applies.</p> <p>any: the policy is effective for every service.</p> <p>The no command resets the service to the default (any).</p>
show	Displays the policy settings.
[no] source address_object	<p>Sets the source IP address or address group for whom this policy applies.</p> <p>The no command resets the source IP address(es) to the default (any). any means all IP addresses.</p>
[no] type {per-user   shared   per-ip-source}	<p>Sets the type of bandwidth management.</p> <p><i>per-user</i>: to allow every user that matches this policy to use up to the bandwidth configured in this policy.</p> <p><i>shared</i>: to have users that match this policy to share the bandwidth configured in this policy.</p> <p><i>per-ip-source</i>: tset the maximum bandwidth for traffic from an individual source IP address.</p> <p>The no command resets the bandwidth management type to the default (shared).</p>
[no] user user_name	<p>Sets a user name or user group to which to apply the policy.</p> <p>The no command resets the user name to the default (any). any means all users.</p>

Table 160 bwm Sub-commands (continued)

COMMAND	DESCRIPTION
<code>priority-code &lt;0..7&gt;</code>	Priority code is applied to outgoing traffic. The BWM policy priority code setting overwrites the VLAN priority code setting.  Sets the priority code for the specified VLAN from 0 (lowest, background traffic) to 7 (highest, network control traffic). This is the priority code for packets in the specified VLAN that don't match the BWM rule.
<code>vlan-priority-code &lt;0..7&gt;</code>	Sets the priority code for matching outgoing traffic in the specified VLAN.
<code>marked-interface interface vlan&lt;1..4064&gt;</code>	When a packet matches BWM criteria, choose the VLAN interface(s) to which to apply the priority code using a <code>marked-interface</code> command.  Marks matching outgoing traffic from the specified VLAN with the configured priority code.
<code>marked-interface any</code>	Marks matching outgoing traffic from any VLAN with the configured priority code.
<code>marked-interface trunk trunk_name</code>	Marks matching outgoing traffic from the specified trunk with the configured priority code.
<code>marked-interface none</code>	Doesn't mark outgoing traffic with priority code for this BWM rule.

### 36.3 Bandwidth Management Commands Examples

The following example sets the priority code to 3 for packets in VLAN 1 that don't match any other BWM rule. BWM rule 1 marks matching outgoing traffic from VLAN 1 to priority code 4.

```
Router(config)# interface vlan1
Router(config-if-vlan)# priority-code 3
Router(config-if-vlan)# exit
Router(config)# bwm 1
Router(config-bwm modify 1)# vlan-priority-code 4
Router(config-bwm modify 1)# marked-interface interface vlan1
Router(config-bwm modify 1)# exit
Router(config)#
```

The following example adds a new bandwidth management policy for trial-users to limit incoming and outgoing bandwidth and sets the traffic priority to 3. It then displays the policy settings.

```
Router# configure terminal
Router(config)# bwm append
Router(config-bwm append 6)# activate
Router(config-bwm append 6)# description example
Router(config-bwm append 6)# user trial-users
Router(config-bwm append 6)# inbound guarantee-bandwidth 800 priority 3
Router(config-bwm append 6)# outbound guarantee-bandwidth 700 priority 3
Router(config-bwm append 6)# show
Current Configuration:
index: 6
  Activate: yes
  Description: example
  BWM Type: shared
  Schedule: none
  User: trial-users
  Incoming_Type: any
  Incoming_Interface: any
  Outgoing_Type: any
  Outgoing_Interface: any
  Src: any
  Dst: any
  Service_Type: service-object
  Service_Name: any
  Inbound_Excess: no
  Inbound_Prio: 3
  Inbound: 800
  Inbound_Ceiling: 0
  Outbound_Excess: no
  Outbound_Prio: 3
  Outbound: 700
  Outbound_Ceiling: 0
  DSCP_Code: any
  DSCP_Inbound: preserve
  DSCP_Outbound: preserve
  Log: no
Router(config-bwm append 6)# exit
Router(config)#
```



# CHAPTER 37

## Application Patrol

This chapter describes how to set up application patrol for the Zyxel Device.

### 37.1 Application Patrol Overview

Application patrol provides a convenient way to manage the use of various applications on the network. It manages general protocols (for example, http and ftp) and instant messenger (IM), peer-to-peer (P2P), Voice over IP (VoIP), and streaming (RSTP) applications. You can even control the use of a particular application's individual features (like text messaging, voice, video conferencing, and file transfers). Application patrol also has powerful bandwidth management including traffic prioritization to enhance the performance of delay-sensitive applications like voice and video.

Note: The Zyxel Device checks firewall rules before application patrol rules for traffic going through the Zyxel Device. To use a service, make sure both the firewall and application patrol allow the service's packets to go through the Zyxel Device.

Application patrol examines every TCP and UDP connection passing through the Zyxel Device and identifies what application is using the connection. Then, you can specify, by application, whether or not the Zyxel Device continues to route the connection.

### 37.2 Application Patrol Commands Summary

The following table describes the values required for many application patrol commands. Other values are discussed with the corresponding commands.

Table 161 Input Values for Application Patrol Commands

LABEL	DESCRIPTION
<i>&lt;profile-name&gt;</i>	Type the name of the profile. You may use 1-31 alphanumeric characters, underscores(_), or dashes (-), but the first character cannot be a number. This value is case-sensitive.
<i>description</i>	This is a description of the App Patrol Profile.

The following sections list the application patrol commands.

## 37.2.1 Application Patrol Commands

This table lists the application patrol commands.

Table 162 app Commands: Application Patrol

COMMAND	DESCRIPTION
[no] app <profile-name>	Creates a profile with the specified name. You may use 1-31 alphanumeric characters, underscores(_), or dashes (-), but the first character cannot be a number. This value is case-sensitive. The no command disables it.
[no] description DESCRIPTION	Write a description of the App Patrol Profile.
application <profile-name> action {forward drop reject} {no log log [alert]}	Sets the action and generates a log, log and alert or neither (no) when traffic matches a signature in this profile. Actions are: <ul style="list-style-type: none"> <li>• <b>forward</b> - routes packets that matches these signatures.</li> <li>• <b>Drop</b> - silently drops packets that matches these signatures without notification.</li> <li>• <b>Reject</b> - drops packets that matches these signatures and sends notification.</li> </ul>
[no] app log_sid	Generate a log when traffic matches a signature in this category. The no command disables it.
app reload signatures	Re-downloads signatures from the update server.
app rename <profile-name> <profile-name>	Renames an existing profile
[no] app statistics collect	Enables application patrol statistics gathering. The no command disables it.
app statistics flush	Clears all application patrol statistics.
app update	Immediately downloads signatures from an update server.
[no] app update auto	Enables (disables) automatic signature downloads at regular times and days.
app update daily <0..23>	Enables automatic signature download every day at the time specified.
app update hourly	Enables automatic signature download every hour.
app update weekly {sun   mon   tue   wed   thu   fri   sat} <0..23>	Enables automatic signature download once-a-week at the time and day specified.
no application-object <profile-name>	Removes the application object from the named profile.
[no] security-service app-patrol activate	Turns on application patrol on the Zyxel Device. The no command disables application patrol.
show app category <category_id>	Shows tag IDs for a specific category.
show app profiles	Shows the description, application name, and object reference number for all application patrol profiles on the Zyxel Device.
show app profiles <profile-name>	Shows the description, application name, and object reference number associated with the named profile.
show app profiles <profile-name> application	Shows the application name, action and log associated with the named profile.
show app profiles <profile-name> application category {category_id   all}	Shows the description, application name, and object reference number associated with the named profile within a specific or all categories.
show app search-name <application_keyword>	Searches for applications that contain the specified keyword.

Table 162 app Commands: Application Patrol

COMMAND	DESCRIPTION
show app signature update	Displays signature update schedule.
show app signatures date	Displays the date (yyyy-mm-dd) and time the set was released.
show app signatures status	Displays details about the current application patrol signature set.
show app signatures version	Displays the App Patrol signature set version number. This number gets larger as the set is enhanced.
show app statistics collect	Shows if application patrol statistics gathering is enabled and if yes, when.
show app statistics summary	Shows a summary of application patrol statistics (if any).
show app tag info	Displays the ID and name of tags for applications.
show app update status	Displays signature update status.
show security-service signature status	Displays details about all current signature sets.
show security-service status	Displays whether the security services are enabled on the Zyxel Device.

### 37.2.1.1 Application Patrol Command Examples

This command shows details of an application patrol profile created.

```
Router# show app profiles
APP-patrol: 1
  profile name: appl
  description:
  application: ultrasurf_app
  ref: 1
```

These are some other example application patrol usage commands

```
Router(config)# show app statistics collect
collect statistics: yes
collect statistics time: since 2014-06-03 05:39:59 to 2014-06-10 06:20:17
Router(config)# show app signatures version
version: 3.1.4.049
Router(config)# show app signatures date
date: 2013-12-05 18:09:51
Router(config)# app john
Router(config-app-patrol-profile-john)# description this is a dummy
profile
Router(config-app-patrol-profile-john)# exit
Router(config)# show app profiles
APP-patrol: 1
  profile name: testfb
  description:
  application: tests
  ref: 0
APP-patrol: 2
  profile name: test
  description: this is a test
  application:
  ref: 0
APP-patrol: 3
  profile name: john
  description: this is a dummy profile
  application:
  ref: 0
Router(config)#
```

# CHAPTER 38

## Anti-Virus

This chapter introduces and shows you how to configure the anti-virus scanner.

Note: This feature is called Anti-Malware on some Zyxel Device models.

### 38.1 Anti-Virus Overview

A computer virus is a small program designed to corrupt and/or alter the operation of other legitimate programs. A worm is a self-replicating virus that resides in active memory and duplicates itself. The effect of a virus attack varies from doing so little damage that you are unaware your computer is infected to wiping out the entire contents of a hard drive to rendering your computer inoperable.

### 38.2 Anti-Virus Commands

The following table identifies the values required for many of these commands. Other input values are discussed with the corresponding commands.

Table 163 Input Values for General Anti-Virus Commands

LABEL	DESCRIPTION
<code>&lt;profile-name&gt;</code>	The name of the profile. You may use 1-31 alphanumeric characters, underscores( <code>_</code> ), or dashes ( <code>-</code> ), but the first character cannot be a number. This value is case-sensitive.
<code>av_file_pattern</code>	<p>Use up to 80 characters to specify a file pattern. Alphanumeric characters, underscores (<code>_</code>), dashes (<code>-</code>), question marks (<code>?</code>) and asterisks (<code>*</code>) are allowed.</p> <p>A question mark (<code>?</code>) lets a single character in the file name vary. For example, use <code>"a?.zip"</code> (without the quotation marks) to specify <code>aa.zip</code>, <code>ab.zip</code> and so on.</p> <p>Wildcards (<code>*</code>) let multiple files match the pattern. For example, use <code>"*a.zip"</code> (without the quotation marks) to specify any file that ends with <code>"a.zip"</code>. A file named <code>"testa.zip"</code> would match. There could be any number (of any type) of characters in front of the <code>"a.zip"</code> at the end and the file name would still match. A file named <code>"test.zipa"</code> for example would not match.</p> <p>A <code>*</code> in the middle of a pattern has the Zyxel Device check the beginning and end of the file name and ignore the middle. For example, with <code>"abc*.zip"</code>, any file starting with <code>"abc"</code> and ending in <code>".zip"</code> matches, no matter how many characters are in between.</p> <p>The whole file name has to match if you do not use a question mark or asterisk.</p> <p>If you do not use a wildcard, the Zyxel Device checks up to the first 80 characters of a file name.</p>

## 38.2.1 General Anti-Virus Commands

The following table describes general anti-virus commands. You must use the `configure terminal` command to enter the configuration mode before you can use these commands.

Note: You must register for the anti-virus service in order to use it (see [Chapter 5 on page 52](#)).

Table 164 General Anti-Virus Commands

COMMAND	DESCRIPTION
<code>[no] anti-virus activate</code>	Enables the anti-virus service. The Anti-Virus service depends on anti-virus service registration.
<code>show anti-virus eicar activation</code>	Displays anti-virus eicar status.
<code>[no] anti-virus cloud-query activate</code>	Enables the cloud-query service. The <code>no</code> command disables the cloud-query service.
<code>show anti-virus cloud-query status</code>	Displays the status of anti-virus cloud-query. Note: This command was removed in firmware version 4.5.0
<code>[no] anti-virus eicar activate</code>	Turns detection of the EICAR test file on or off.
<code>anti-virus scan mode {express   hybrid   stream}</code>	Sets the anti-virus scan mode. <ul style="list-style-type: none"> <li>Express: The Zyxel Device scans files that match the list of user-defined file types using cloud query. This is the fastest scan mode.</li> <li>Hybrid: The Zyxel Device scans files that match the list of user-defined file types using cloud query, anti-malware signatures, and Threat Intelligence Machine Learning (if supported). This mode offers a balance of speed and security.</li> <li>Stream: The Zyxel Device scans all files using anti-malware signatures and Threat Intelligence Machine Learning (if supported). This is the deepest scan mode.</li> </ul> Note: Some device models do not support hybrid mode.
<code>show anti-virus scan mode status</code>	Displays the current anti-virus scan mode.
<code>[no] anti-virus cloud-query filetype-identify file_type</code>	Adds or removes a file type from the list of user-defined file types that cloud query will scan. Allowed values: 7z, AVI, BMP, BZ2, EXE, Flash, GIF, Gz, JPG, MOV, MP3, MPG, "MS Office", PNG, RAR, RM, TIFF, WAV, ZIP.
<code>show anti-virus cloud-query filetype-identify status</code>	Displays the list of user-defined file types that cloud query will scan.
<code>anti-virus reload signatures</code>	Recovers anti-virus signatures. You only need to do this if instructed by a support technician.
<code>[no] anti-virus skip-unknown-file-type activate</code>	Sets whether or not anti-virus checks unknown file types.
<code>show anti-virus skip-unknown-file-type activation</code>	Displays whether or not anti-virus checks unknown file types.
<code>anti-virus mail-infect-ext activate</code>	Has the Zyxel Device add a notification text file to an e-mail after modifying a virus-infected e-mail attachment.
<code>no anti-virus mail-infect-ext activate</code>	Has the Zyxel Device not add a notification text file to an e-mail after identifying an infected file.
<code>[no] security-service anti-virus activate</code>	Turns on anti-virus on the Zyxel Device. The <code>no</code> command disables anti-virus.

Table 164 General Anti-Virus Commands (continued)

COMMAND	DESCRIPTION
<code>security-service anti-virus inspect {all-traffic   by-policy}</code>	<p>Sets how the security service inspects traffic.</p> <p><i>all-traffic</i>: The security service inspects all traffic passing through the Zyxel Device.</p> <p><i>by-policy</i>: The security service inspects traffic only when its profile is bound to a security policy.</p> <p>For information on binding a security service profile to a security policy, see <a href="#">Section 29.2.1 on page 219</a>.</p> <p>Note: This command is only available when <code>secure-policy-style</code> is set to advanced. For details, see <a href="#">Section 29.2.2 on page 221</a>.</p>
<code>show security-service status</code>	Displays whether the security services are enabled on the Zyxel Device.

## 38.2.2 Anti-Virus Profile

On Zyxel Devices that do not support multiple profiles, edit the profile named **default\_profile** to change settings in the Web Configurator UI.

Table 165 Anti-Virus Profile Commands

COMMAND	DESCRIPTION
<code>anti-virus rename old_profile_name new_profile_name</code>	Renames the AV profile.
<code>anti-virus profile_name</code>	Enters the anti-virus sub-command mode to edit the specified anti-virus profile.
<code>[no] bypass {white-list   black-list}</code>	When enabled, files are not checked against the white-list and/or black-list.
<code>description profile_description</code>	Adds a description to the profile.
<code>[no] file-decompression</code> <code>[unsupported destroy]</code>	<p>Enable file decompression to have the Zyxel Device attempt to decompress zipped files for further scanning.</p> <p><b>unsupported destroy</b>: Have the Zyxel Device “destroy” (overwrite the infected portion of the file with zeros before forwarding to the user) zipped files it cannot decompress due to encryption or system resource limitations.</p> <p>Note: The Zyxel Device cannot decompress compressed files within a compressed file.</p>
<code>[no] infected-action {destroy   send-win-msg}</code>	<p>Sets the action to take when the Zyxel Device detects a virus in a file.</p> <p>The file can be “destroyed” (overwrite a portion of the file with zeros before forwarding to the user). The Zyxel Device can also send a message alert to the user using a Microsoft Windows computer connected to the to interface.</p>
<code>[no] log [alert]</code>	Set whether the Zyxel Device should create a log message and an optional alert if it finds a virus in a file.
<code>[no] scan {http   ftp   imap4   smtp   pop3}</code>	Sets the traffic protocols you want to scan for viruses.
<code>show [all]</code>	Displays the details of the anti-virus rule you are configuring or all the rules.
<code>exit</code>	Leaves the sub-command mode.

Table 165 Anti-Virus Profile Commands

COMMAND	DESCRIPTION
<code>show anti-virus profile [profile_name]</code>	Displays details of the named profile.
<code>show anti-virus profile</code>	Displays all anti-virus profiles.

### 38.2.2.1 Anti-Virus Profile Command Example

This is an example of anti-virus profile commands.

```
Router(config)# anti-virus officel
Router(config-av-profile-officel)# infected-action destroy
Router(config-av-profile-officel)# file-decompression
Router(config-av-profile-officel)# no file-decompression unsupported
destroy
Router(config-av-profile-officel)# exit
Router(config)# show an
anti-spam anti-virus
Router(config)# show anti-virus profile officel
Anti-Virus Rule: 3
  name: officel
  description:
  log: log
  file decompression: yes
  destroy unsupported compressed file: no
  destroy infected compressed file: yes
  reference count: 0
```

### 38.2.3 White and Black Lists

The following table describes the commands for configuring the white list and black list. You must use the `configure terminal` command to enter the configuration mode before you can use these commands.

Table 166 Commands for the Anti-Virus Black List

COMMAND	DESCRIPTION
<code>[no] anti-virus black-list activate</code>	Activates or deactivates the black list.  When activated, the Zyxel Device logs and deletes files with names that match any of the black list file patterns.
<code>show anti-virus black-list status</code>	Displays whether the black list is currently activated or deactivated.
<code>show anti-virus black-list</code>	Displays a list of patterns in the black list. The list also displays each pattern's index number, and whether the pattern is currently activated.
<code>anti-virus black-list {md5-hash <i>md5-pattern</i>   file-pattern <i>file-pattern</i>} {activate deactivate}</code>	Adds an MD5 hash pattern or file pattern to the black list if it did not already exist, and then activates or deactivates the pattern.



Table 166 Commands for the Anti-Virus Black List (continued)

COMMAND	DESCRIPTION
<code>no anti-virus black-list {md5-hash <i>md5-pattern</i>   file-pattern <i>file-pattern</i>}</code>	Removes an MD5 hash pattern or file pattern from the black list.
<code>anti-virus black-list {replace &lt;1..256&gt;  file-pattern <i>file-pattern</i> md5-hash <i>md5-pattern</i>}</code>	Replaces the black list pattern that has the specified index number with a new pattern. The new pattern can be a file pattern or an MD5 hash pattern.  <1..256>: The index number of the file pattern or MD5 hash pattern that you want to replace.  <i>file-pattern</i> : The new file pattern.  <i>md5-pattern</i> : The new MD5 hash pattern.

Table 167 Commands for the Anti-Virus White List

COMMAND	DESCRIPTION
<code>[no] anti-virus white-list activate</code>	Activates or deactivates the white list.  When activated, the Zyxel Device does not perform anti-virus checks on files that match any of the white list file patterns.
<code>show anti-virus white-list status</code>	Displays whether the white list is currently activated or deactivated.
<code>show anti-virus white-list</code>	Displays a list of patterns in the white list. The list also displays each pattern's index number, and whether the pattern is currently activated.
<code>anti-virus white-list {md5-hash <i>md5-pattern</i>   file-pattern <i>file-pattern</i>} {activate deactivate}</code>	Adds an MD5 hash pattern or file pattern to the white list if it did not already exist, and then activates or deactivates the pattern.
<code>no anti-virus white-list {md5-hash <i>md5-pattern</i>   file-pattern <i>file-pattern</i>}</code>	Removes an MD5 hash pattern or file pattern from the white list.
<code>anti-virus white-list {replace &lt;1..256&gt;  file-pattern <i>file-pattern</i> md5-hash <i>md5-pattern</i>}</code>	Replaces the white list pattern that has the specified index number with a new pattern. The new pattern can be a file pattern or an MD5 hash pattern.  <1..256>: The index number of the file pattern or MD5 hash pattern that you want to replace.  <i>file-pattern</i> : The new file pattern.  <i>md5-pattern</i> : The new MD5 hash pattern.

### 38.2.3.1 White and Black Lists Example

This example shows how to enable the white list and configure an active white list entry for files with a .exe extension. It also enables the black list and configures an inactive black list entry for files with a .exe extension.

```
Router(config)# anti-virus white-list activate
Router(config)# anti-virus white-list file-pattern
Router(config)# anti-virus white-list file-pattern *.exe activate
Router(config)# anti-virus black-list activate
Router(config)# anti-virus black-list file-pattern *.exe deactivate
Router(config)# show anti-virus white-list status
anti-virus white-list status: yes
Router(config)# show anti-virus white-list
No.  Status
File-Pattern
=====
1    yes
*.exe
Router(config)# show anti-virus black-list status
anti-virus black-list status: yes
Router(config)# show anti-virus black-list
No.  Status
File-Pattern
=====
1    no
*.exe
```

### 38.2.4 Signature Search Anti-Virus Command

The following table describes the command for searching for signatures. You must use the `configure terminal` command to enter the configuration mode before you can use this command.

Table 168 Command for Anti-Virus Signature Search

COMMAND	DESCRIPTION
<code>show anti-virus search signature {all   name virus_name} [{from id to id}]</code>	Searches for signatures by name. Type the ID or part of the ID that you want to find.

#### 38.2.4.1 Signature Search Example

This example shows how to search for anti-virus signatures with MSN in the name.

```
Router(config)# anti-virus search signature name MSN
signature: 1
virus name: MSN
```

## 38.3 Update Anti-Virus Signatures

Use these commands to update new signatures. You should be registered for anti-virus service to use these.

Table 169 Update Signatures

COMMAND	DESCRIPTION
[no] anti-virus update auto	Enables (disables) automatic signature downloads at regular times and days.
anti-virus update ctddb	Immediately downloads the Cloud Threat Database signature from an update server.
anti-virus update daily <0..23>	Enables automatic signature download every day at the time specified.
anti-virus update hourly	Enables automatic signature download every hour.
anti-virus update signatures	Immediately downloads the anti-virus signatures from an update server.
anti-virus update weekly {sun   mon   tue   wed   thu   fri   sat} <0..23>	Enables automatic signature download once-a-week at the time and day specified.
show anti-virus update	Displays the signature update schedule.
show anti-virus update status	Displays the signature update status.
show anti-virus signatures status	Displays details about the current anti-virus signature set.
show security-service signature status	Displays details about all current signature sets.

### 38.3.1 Update Signature Examples

These examples show how to enable/disable automatic anti-virus downloading, schedule updates, display the schedule, display the update status, show the (new) updated signature version number, show the total number of signatures and show the date/time the signatures were created.

```

Router# configure terminal
Router(config)# anti-virus update signatures
ANTI-VIRUS signature update in progress.
Please check system log for future information.
Router(config)# anti-virus update auto
Router(config)# no anti-virus update auto
Router(config)# anti-virus update hourly
Router(config)# anti-virus update daily 10
Router(config)# anti-virus update weekly fri 13
Router(config)# show anti-virus update
auto: yes
schedule: weekly at Friday 13 o'clock
Router(config)# show anti-virus update status
current status: Anti-Virus Current signature version 1.046 on device is
latest at Tue Apr 17 10:18:00 2007
last update time: 2007/04/07 10:41:01
Router(config)# show anti-virus signatures status
current version : 1.046
release date    : 2007/04/06 10:41:29
signature number: 686000
SSII (signature) number: 6000
SSII(md5 checksum) number: 680000

```

## 38.4 Anti-Virus Statistics

The following table describes the commands for collecting and displaying anti-virus statistics. You must use the `configure terminal` command to enter the configuration mode before you can use these commands.

Table 170 Commands for Anti-Virus Statistics

COMMAND	DESCRIPTION
<code>[no] anti-virus statistics collect</code>	Turns the collection of anti-virus statistics on or off.
<code>anti-virus statistics flush</code>	Clears the collected statistics.
<code>show anti-virus statistics summary</code>	Displays the collected statistics.
<code>show anti-virus statistics collect</code>	Displays whether the collection of anti-virus statistics is turned on or off.
<code>show anti-virus statistics ranking {destination   destination6   source   source6   virus-name}</code>	<p>Queries and sorts anti-virus statistics entries by destination IP address, source IP address, or virus name.</p> <p><code>virus-name</code>: lists the most common viruses detected.</p> <p><code>source (6)</code>: lists the source IP addresses (IPv4 or IPv6) having the most number virus-infected files.</p> <p><code>destination (6)</code>: lists the most common destination IP addresses (IPv4 or IPv6) for virus-infected files.</p>

### 38.4.1 Anti-Virus Statistics Example

This example shows how to collect and display anti-virus statistics. It also shows how to sort the display by the most common destination IP addresses.

```
Router(config)# anti-virus statistics collect
Router(config)# show anti-virus statistics collect
collect statistics: yes
Router(config)# show anti-virus statistics summary
virus detected: 0
Router(config)# show anti-virus statistics ranking destination
```

# CHAPTER 39

## RTLS

### 39.1 RTLS Overview

Ekahau RTLS (Real Time Location Service) tracks battery-powered Wi-Fi tags attached to APs managed by the Zyxel Device to create maps, alerts, and reports.

The Ekahau RTLS Controller is the centerpiece of the RTLS system. This server software runs on a Windows computer to track and locate Ekahau tags from Wi-Fi signal strength measurements. Use the Zyxel Device with the Ekahau RTLS system to take signal strength measurements at the APs (Integrated Approach / Blink Mode).

You need:

- At least three APs managed by the Zyxel Device (the more APs the better since it increases the amount of information the Ekahau RTLS Controller has for calculating the location of the tags)
- IP addresses for the Ekahau Wi-Fi tags
- A dedicated RTLS SSID is recommended
- Ekahau RTLS Controller in blink mode with TZSP Updater enabled
- Secure policies to allow RTLS traffic if the Zyxel Device Secure Policy control is enabled or the Ekahau RTLS Controller is behind a firewall.

For example, if the Ekahau RTLS Controller is behind a firewall, open ports 8550, 8553, and 8569 to allow traffic the APs send to reach the Ekahau RTLS Controller.

The following table lists default port numbers and types of packets RTLS uses.

Table 171 RTLS Traffic Port Numbers

PORT NUMBER	TYPE	DESCRIPTION
8548	TCP	Ekahau T201 location update.
8549	UDP	Ekahau T201 location update.
8550	TCP	Ekahau T201 tag maintenance protocol and Ekahau RTLS Controller user interface.
8552	UDP	Ekahau Location Protocol
8553	UDP	Ekahau Maintenance Protocol
8554	UDP	Ekahau T301 firmware update.
8560	TCP	Ekahau Vision web interface
8562	UDP	Ekahau T301W firmware update.
8569	UDP	Ekahau TZSP Listener Port

## 39.1.1 RTLS Configuration Commands

Use these commands to configure RTLS on the Zyxel Device.

Table 172 RTLS Commands

COMMAND	DESCRIPTION
[no] rtls ekahau activate	Enables RTLS to use Wi-Fi to track the location of Ekahau Wi-Fi tags. The no command disables tracking.
rtls ekahau ip address <ip>	Specifies the IP address of the Ekahau RTLS Controller.
rtls ekahau ip port <1..65535>	Specifies the server port of the Ekahau RTLS Controller.
show rtls ekahau config	Displays RTLS configuration details.
show rtls ekahau cli	Displays commands run on the AP. The AP runs the flush command before executing other commands.

## 39.1.2 RTLS Configuration Examples

The following commands show how to enable RTLS to use Wi-Fi to track the location of Ekahau Wi-Fi tags, specify the IP address of the Ekahau RTLS Controller and then show the configuration settings.

```
Router# configure terminal
Router(config)# rtls ekahau activate
Router(config)# rtls ekahau ip address 1.1.1.1
Router(config)# exit
Router# show rtls ekahau config
ekahau activate: yes
ekahau address: 1.1.1.1
ekahau port: 8569
Router#
```

The following command displays the commands run on the AP.

```
Router(config)# show rtls ekahau cli
!
rtls ekahau flush
!
rtls ekahau ip port 11111
rtls ekahau ip address 1.1.1.1
rtls ekahau activate
!
Router(config)#
```

# CHAPTER 40

## Reputation Filter

This chapter introduces and shows you how to configure IP reputation and URL filtering.

### 40.1 Overview

#### IP Reputation

IP reputation checks the reputation of an IP address from a database. An IP address with bad reputation associates with suspicious activities, such as spam, virus, and/or phishing. The Zyxel Device will respond when there are packets coming from an IPv4 address with bad reputation.

#### URL Threat Filter

URL filtering compares access to specific URLs against a database of blocked or allowed sites. Sites on the database are sorted into categories such as:

Anonymizers	Browser Exploits
Malicious Downloads	Malicious Sites
Phishing	Spam URLs
Spyware Adware Keyloggers	

Note: This feature was previously called Anti-Botnet Filter.

#### DNS Threat Filter

DNS threat filtering inspects DNS queries made by clients on your network and compares the queries against a database of blocked or allowed Fully Qualified Domain Names (FQDNs). The Zyxel Device DNS Threat Filter will either drop the DNS query or reply to the user with a fake DNS response.

The following types of DNS queries are inspected by the Zyxel Device:

- Type "A" ...
- Type "AAAA" ...
- Type "NS" ...
- Type "MX" ...
- Type "CNAME" ...
- Type "PTR" ...
- Type "SOA" ...

The Zyxel Device replies with a DNS reply packet containing a fake IP address for type "A", and replies with a DNS reply packet with server failure code for remaining types.

## 40.1.1 Signature Database Priority

The Zyxel Device checks the URL Threat Filter signature databases in the following order:

1. White List
2. Black List
3. External Black List
4. Local Signature Database
5. Cloud Query Cache
6. Cloud Query

The Zyxel Device checks the DNS Threat Filter signature databases in the following order:

1. White List
2. Black List
3. Local Signature Database
4. Cloud Query Cache
5. Cloud Query

## 40.2 IP Reputation Commands

The following table describes general IP reputation commands. You must use the `configure terminal` command to enter the configuration mode before you can use these commands.

Table 173 IP Reputation Commands

COMMAND	DESCRIPTION
[no] security-service ip-reputation activate	Enables the IP reputation filtering service on the Zyxel Device.  The <code>no</code> command disables the IP reputation filtering service.
show security-service status	Displays whether security services such as IP reputation filtering are enabled on the Zyxel Device.
ip-reputation action {block   pass}	Sets what action the Zyxel Device takes when a packet arrives from an IPv4 address with a bad reputation.  <code>pass</code> : The Zyxel Device allows the packet to go through.  <code>block</code> : The Zyxel Device denies the packet, and then sends a TCP RST to both the packet sender and receiver.
ip-reputation action-level {high   medium   low}	Sets the threshold threat level to which the Zyxel Device will take action ( <b>high</b> , <b>medium</b> , and <b>low</b> ).  The threat level is determined by the IP reputation engine, which grades IPv4 addresses. <ul style="list-style-type: none"> <li>• <b>high</b>: An IPv4 address that scores 0 to 20 points.</li> <li>• <b>medium</b>: An IPv4 address that scores 0-60 points.</li> <li>• <b>low</b>: An IPv4 address that scores 0-80 points.</li> </ul>
[no] ip-reputation log [alert]	The Zyxel Device creates a log message and sends an optional alert when packets arrive from an IPv4 address with a bad reputation.
[no] ip-reputation log-all	The Zyxel Device creates a log message each time an IPv4 address is scanned using IP reputation.
show ip-reputation status	Displays the action and log settings for IP reputation.
show ip-reputation signatures date	Displays the date and time the signature set was released.



Table 173 IP Reputation Commands (continued)

COMMAND	DESCRIPTION
<code>show ip-reputation signatures number</code>	Displays the number of signatures in this set.
<code>show ip-reputation signatures version</code>	Displays the signature set version number currently used by the Zyxel Device. This number gets larger as new signatures are added.
<code>[no] ip-reputation white-list activate</code>	Turns on the IP reputation white list, and the Zyxel Device will allow the incoming packets that come from the listed IPv4 addresses.
<code>ip-reputation white-list {IPv4   IPv4CIDR} {activate deactivate}</code>	Activates or deactivates the specified IPv4 address on the IP reputation white list.  You can also add an IP address block using CIDR notation, for example 192.168.0.1/24.
<code>ip-reputation white-list replace &lt;1..256&gt; IPv4 {activate deactivate}</code>	Replaces the IPv4 address of the specified entry with a new one on the IP reputation white list.
<code>no ip-reputation white-list IPv4</code>	Removed the specified IPv4 address from the IP reputation white list.
<code>[no] ip-reputation black-list activate</code>	Turns on the IP reputation black list, and the Zyxel Device will block the incoming packets that come from the listed IPv4 addresses.
<code>ip-reputation black-list {IPv4   IPv4CIDR} {activate deactivate}</code>	Activates or deactivates the specified IPv4 address on the IP reputation black list.  You can also add an IP address block using CIDR notation, for example 192.168.0.1/24.
<code>ip-reputation black-list replace &lt;1..256&gt; IPv4 {activate deactivate}</code>	Replaces the IPv4 address of the specified entry with a new one on the IP reputation black list.
<code>no ip-reputation black-list IPv4</code>	Removed the specified IPv4 address from the IP reputation black list.
<code>show ip-reputation {white-list black-list}</code>	Displays the current IP reputation white or black list.
<code>show ip-reputation {white-list black-list} status</code>	Displays if the IP reputation white or black list is turned on or not.
<code>[no] ip-reputation webroot incoming-category {botnets   denial-of-service   exploits   phishing   proxy   reputation   scanners   spam-sources   tor-proxy   web-attacks}</code>	Select the categories of packets coming from the Internet that the Zyxel Device applies IP reputation filtering to.
<code>[no] ip-reputation webroot outgoing-category {botnets   phishing}</code>	Select the categories of packets coming from the Internet or local networks that the Zyxel Device applies IP reputation filtering to.  Note: In Firmware v4.55 or later, the phishing option does nothing and is only included for compatibility.
<code>show ip-reputation webroot {incoming-category   outgoing-category}</code>	Displays whether each category of packet coming from the Internet or Internet and local networks is filtered.

## 40.2.1 Update IP Reputation Signatures

Use these commands to update new signatures. You should have already registered for IP reputation service.

Table 174 Update Signatures

COMMAND	DESCRIPTION
<code>ip-reputation update signatures</code>	Immediately downloads signatures from an update server.
<code>[no] ip-reputation update auto</code>	Enables (disables) automatic signature downloads at regular times and days.
<code>ip-reputation update daily &lt;0..23&gt;</code>	Enables automatic signature download every day at the time specified.
<code>ip-reputation update hourly</code>	Enables automatic signature download every hour.
<code>ip-reputation update weekly {sun   mon   tue   wed   thu   fri   sat} &lt;0..23&gt;</code>	Enables automatic signature download once-a-week at the time and day specified.
<code>show ip-reputation signature update</code>	Displays signature update schedule.
<code>show ip-reputation update status</code>	Displays signature update status.
<code>show ip-reputation search {Ipv6Address   Ipv4Address}</code>	Searches for the specified IPv4 or IPv6 address in the Zyxel Device's internal and external IP reputation databases, and then displays the IP address's threat level.

## 40.2.2 IP Reputation Statistics

The following table describes the commands for collecting and displaying IP reputation statistics. You must use the `configure terminal` command to enter the configuration mode before you can use these commands.

Table 175 Commands for IP Reputation Statistics

COMMAND	DESCRIPTION
<code>ip-reputation statistics flush</code>	Clears the collected IP reputation statistics.
<code>[no] ip-reputation statistics collect</code>	Turns the collection of IP reputation statistics on or off.
<code>show ip-reputation statistics recent-activities</code>	Displays a list of connection attempts to or from the IP reputation addresses.
<code>show ip-reputation statistics collect status</code>	Displays whether the collection of IP reputation statistics is turned on or off.
<code>show ip-reputation statistics summary</code>	Displays the collected IP reputation statistics.

## 40.2.3 IP Reputation External Black List

The following table describes the commands for enabling and configuring an external database of black listed IP addresses. The Zyxel Device blocks incoming and outgoing packets from the addresses in

this file.

- The external black list file must be in text format (\*.txt) with each entry separated by a new line.
- The external black list file must be stored on a web server that supports HTTP or HTTPS, and that is reachable from the Zyxel Device.
- Each entry consists of a single IPv4/IPv6 IP address, a IPv4/IPv6 subnet in CIDR (Classless Inter-Domain Routing) format, or an IPv4/IPv6 IP address range. For example:  
104.244.79.43  
188.68.0.266/31  
1.1.1.1-1.1.1.3  
2001:b000:168::1
- The external black list file can contain a maximum of 50,000 entries.
- If the external black list file contains any invalid entries, the Zyxel Device will not use the file.

Table 176 Commands for IP Reputation Statistics

COMMAND	DESCRIPTION
[no] ip-reputation ebl activate	Enables or disables the IP Reputation external black list.  When enabled, the Zyxel Device blocks incoming packets that come from the listed addresses in the black list file.
ip-reputation ebl <profile name>	Enters the subcommand mode for the specified external black list profile. If the profile does not exist, the Zyxel Device creates it.  Note: After creating a new profile, you must add a source URL. Failure to do so might result in an error when starting the Zyxel Device.
description <description>	Enter a description of the external black list file.  The description must consist of 1–60 characters, and may include letters, numbers, and the following special characters: ( ) + / : = ? ! * # @ \$ _ % -  Use the no command to delete the description for this profile.
source <url>	Adds the exact file name, path and IP address of the server containing the external black list file.  For example, http://172.16.107.20/blacklist-files/myip-ebl.txt  The server must be reachable from the Zyxel Device.
no ip-reputation ebl <profile name>	Deletes the specified external black list profile.
ip-reputation ebl rename old_profile_name new_profile_name	Renames the specified external black list profile.
[no] ip-reputation ebl update auto	Sets the Zyxel Device to automatically check for updates to the external black list at the time and day specified. You should select a time when your network is not busy for minimal interruption.  The [no] command disables the automatic updates.
ip-reputation ebl update hourly	Sets the Zyxel Device to check for updates to the external black list every hour.
ip-reputation ebl update daily <0..23>	Sets the Zyxel Device to check for updates to the external black list once per day, at the specified hour. For example, the time format is the 24 hour clock, so '23' means 11 PM.

Table 176 Commands for IP Reputation Statistics (continued)

COMMAND	DESCRIPTION
<code>ip-reputation ebl update weekly {sun /mon/tue/wed/thu/fri/sat} &lt;0..23&gt;</code>	Sets the Zyxel Device to check for updates to the external black list once per week, on the specified day at the specified hour.
<code>ip-reputation ebl update</code>	Checks for updates to the external black list immediately.
<code>show ip-reputation ebl</code>	Shows all IP Reputation external black list profiles.
<code>show ip-reputation ebl &lt;profile name&gt;</code>	Shows the specified IP Reputation external black list profile.
<code>show ip-reputation ebl signature update</code>	Shows whether automatic external black list updates are enabled, and the schedule for the updates.
<code>show ip-reputation ebl &lt;1..4&gt; {date   number}</code>	Shows how many addresses are in the specified external black list profile, or the date that the external black list file was last updated.  The profile is identified by its ID number, which can be viewed by running the command <code>show ip-reputation ebl</code> .

## 40.3 URL Threat Filter Commands

The following table describes general URL Threat Filter commands. You must use the `configure terminal` command to enter the configuration mode before you can use these commands.

Table 177 URL Threat Filter Commands

COMMAND	DESCRIPTION
<code>anti-botnet action {forward   reject-both   reject-receiver   reject-sender}</code>	Sets what action the Zyxel Device takes when a packet contains a malicious URL.  <code>forward</code> : The Zyxel Device allows the packet to go through.  <code>reject-sender</code> : The Zyxel Device blocks the packet and sends a TCP RST to the sender.  <code>reject-receiver</code> : The Zyxel Device denies the packet and sends a TCP RST to the receiver.  <code>reject-both</code> : The Zyxel Device denies the packets and sends a TCP RST to both the sender and receiver.
<code>[no] anti-botnet log [alert]</code>	Creates a log on the Zyxel Device (and sends an optional alert) when the packet contains a malicious URL.
<code>[no] security-service anti-botnet-IP activate</code>	Enables the URL Threat Filter service on the Zyxel Device.  The <code>no</code> command disables the service.
<code>[no] threat-website trust-list activate</code>	Enables or disables the URL Threat Filter whitelist.
<code>[no] threat-website forbid-list activate</code>	Enables or disables the URL Threat Filter black list.
<code>show anti-botnet signatures date</code>	Displays the date and time the signature set was released.
<code>show anti-botnet signatures number</code>	Displays the number of signatures in this set.

Table 177 URL Threat Filter Commands (continued)

COMMAND	DESCRIPTION
<code>show anti-botnet signatures version</code>	Displays the signature set version number currently used by the Zyxel Device. This number gets larger as new signatures are added.
<code>show anti-botnet status</code>	Displays the action and log settings for the URL Threat Filter service.
<code>show security-service status</code>	Displays whether security services such as anti-malware are enabled on the Zyxel Device.
<code>show threat-website status</code>	Displays the action, log, message and category settings for the URL Threat Filter service.
<code>show threat-website {trust forbid}</code>	Displays the current URL Threat Filter white list (trust) or black list (forbid).
<code>[no] threat-website action {block   log   pass   warn}</code>	<p>Sets what action the Zyxel Device takes when it detects a connection attempt to or from the web pages of the specified categories.</p> <p><b>block:</b> The Zyxel Device blocks access to the web pages that match the categories that you specified.</p> <p><b>log:</b> The Zyxel Device creates a log when it detects a connection attempt to or from the web pages of the specified categories.</p> <p><b>warn:</b> The Zyxel Device displays a warning message to the access requesters for the web pages before allowing users to access web pages that match the categories that you specified.</p> <p><b>pass:</b> The Zyxel Device allows access to the web pages that match the categories that you specified.</p>
<code>[no] threat-website block message message</code>	<p>Sets a message to be displayed when the URL Threat Filter blocks access to a web page.</p> <p><b>message:</b> Use up to 127 characters (0-9a-zA-Z/?:@&amp;=+\$\._!~*()%,). For example, "Access to this web page is not allowed. Please contact the network administrator".</p>
<code>[no] threat-website block redirect url</code>	<p>Sets the URL of the web page to which you want to send users when their web access is blocked by the URL Threat Filter. The web page you specify here opens in a new frame below the denied access message.</p> <p><b>url:</b> Use "http://" or "https://" followed by up to 262 characters (0-9a-zA-Z/?:@&amp;=+\$\._!~*()%,). For example, http://192.168.1.17/blocked access.</p>
<code>[no] threat-website category {anonymizers   browser-exploits   botnets   compromised   malicious-downloads   malicious-sites   malware   phishing   phishing-fraud   spam-sites   spam-urls   spyware-adware-keyloggers}</code>	<p>The Zyxel Device blocks the specified web page categories. The <i>no</i> command unblocks the specified category.</p> <p>For compatibility, legacy categories are still included as options and map to the following new categories:</p> <ul style="list-style-type: none"> <li>• phishing-fraud -&gt; phishing</li> <li>• spam-sites -&gt; spam-urls</li> <li>• compromised, malware, botnets -&gt; malicious-sites</li> </ul>
<code>threat-website {trust   forbid}</code>	Enters sub command mode, where you can add or remove web site entries in the white list (trust) or black list (forbid).

Table 177 URL Threat Filter Commands (continued)

COMMAND	DESCRIPTION
[no] { <i>ipv4</i>   <i>ipv4_cidr</i>   <i>ipv4_range</i>   <i>wildcard_domainname</i>   <i>top_level_domain</i> }	<p><i>ipv4</i>: IPv4 address &lt;W.X.Y.Z&gt;</p> <p><i>ipv4_cidr</i>: IPv4 subnet in CIDR format, i.e. 192.168.1.0/32&lt;W.X.Y.Z&gt;/&lt;1..32&gt;</p> <p><i>ipv4_range</i>: Range of IPv4 addresses. &lt;W.X.Y.Z&gt;-&lt;W.X.Y.Z&gt;</p> <p><i>wildcard_domainname</i>: Wildcard domain name, in the format <i>String1.String2</i>. For example: <i>zyxel*.co*</i></p> <ul style="list-style-type: none"> <li>String 1 must consist of 1–63 characters, and may include letters, numbers, and the following special characters: - (hyphen), . (period), * (wildcard character).</li> <li>String 2 must consist of 1–63 characters, and may include letters, numbers, and the following special characters: - (hyphen), * (wildcard character).</li> </ul> <p><i>top_level_domain</i>: Top level domain. for example: <i>zyxel.com</i>.</p>
exit	Leaves the sub-command mode.
security-service threat-website inspect { <i>all-traffic</i>   <i>by-policy</i> }	<p>Sets how the security service inspects traffic.</p> <p><i>all-traffic</i>: The security service inspects all traffic passing through the Zyxel Device.</p> <p><i>by-policy</i>: The security service inspects traffic only when its profile is bound to a security policy.</p> <p>For information on binding a security service profile to a security policy, see <a href="#">Section 29.2.1 on page 219</a>.</p>

### 40.3.1 URL Threat Filter Profile Commands

On Zyxel Devices that do not support multiple profiles, edit the profile named **default\_profile** to change settings in the Web Configurator UI.

Table 178 URL Threat Filter Profile Commands

COMMAND	DESCRIPTION
threat-website rename <i>old_profile_name</i> <i>new_profile_name</i>	Renames the URL Threat Filter profile.
threat-website profile <i>profile_name</i>	Creates the specified URL Threat Filter profile, if it does not already exist.
threat-website profile < <i>profile name</i> > action { <i>block</i>   <i>pass</i>   <i>warn</i> }	<p>Sets what action the Zyxel Device takes when it detects a connection attempt to or from the web pages of the specified categories.</p> <p><i>block</i>: The Zyxel Device blocks access to the web pages that match the categories that you specified.</p> <p><i>pass</i>: The Zyxel Device allows access to the web pages that match the categories that you specified.</p> <p><i>warn</i>: The Zyxel Device displays a warning message to the access requesters for the web pages before allowing users to access web pages that match the categories that you specified.</p>
[no] threat-website profile < <i>profile name</i> > description < <i>description</i> >	Adds a description to the profile.

Table 178 URL Threat Filter Profile Commands

COMMAND	DESCRIPTION
[no] threat-website profile <profile name> {forbid   trust   ebl}	Enables or disables the the black list (forbid), the whitelist (trust) and the external black list (ebl) for this profile.
[no] threat-website profile <profile name> log	Set whether the Zyxel Device should create a log message if it detects a hit.
[no] threat-website profile <profile name> category {anonymizers   malware   botnets   phishing   browser-exploits   phishing-fraud   compromised   spam-sites   malicious-downloads   spam-urls   malicious-sites   spyware-adware-keyloggers}	<p>The profile blocks the specified web page categories. The <i>no</i> command unblocks the specified category.</p> <p>For compatibility, legacy categories are still included as options and map to the following new categories:</p> <ul style="list-style-type: none"> <li>• phishing-fraud -&gt; phishing</li> <li>• spam-sites -&gt; spam-urls</li> <li>• compromised, malware, botnets -&gt; malicious-sites</li> </ul>

### 40.3.2 URL Threat Filter External Black List

The following table describes the commands for enabling and configuring an external database of blacklisted URLs. The Zyxel Device blocks incoming and outgoing packets from the addresses in this file.

- The external black list file must be in text format (\*.txt) with each entry separated by a new line.
- The external black list file must be stored on a web server that supports HTTP or HTTPS, and that is reachable from the Zyxel Device.
- Each entry consists of a URL, domain name, or domain name with wildcard \*. For example:  
https://www.zyxel.com/products\_services/smb.shtml?t=s  
www.zyxel.com  
\*.zyxel.\*
- The external black list file can contain a maximum of 50,000 entries.
- If the external black list file contains any invalid entries, the Zyxel Device will not use the file.

Table 179 Commands for URL Threat Filter External Black List

COMMAND	DESCRIPTION
[no] threat-website ebl activate	<p>Enables or disables the URL Threat Filter external black list.</p> <p>When enabled, the Zyxel Device blocks incoming packets that come from the listed addresses in the black list file.</p>
threat-website ebl <profile name>	<p>Enters the subcommand mode for the specified external black list profile. If the profile does not exist, the Zyxel Device creates it.</p> <p>Note: After creating a new profile, you must add a source URL. Failure to do so might result in an error when starting the Zyxel Device.</p>
description <description>	<p>Enter a description of the external black list file.</p> <p>The description must consist of 1–60 characters, and may include letters, numbers, and the following special characters: ( ) + / : = ? ! * # @ \$ _ % -</p> <p>Use the <i>no</i> command to delete the description for this profile.</p>

Table 179 Commands for URL Threat Filter External Black List (continued)

COMMAND	DESCRIPTION
<code>source &lt;url&gt;</code>	Adds the URL of the external black list file.  For example, <code>https://zyxel.com.tw/blacklist-files/myip-eb1.txt</code> . The server must be reachable from the Zyxel Device.
<code>no threat-website ebl &lt;profile name&gt;</code>	Deletes the specified external black list profile.
<code>threat-website ebl rename old_profile_name new_profile_name</code>	Renames the specified external black list profile.
<code>[no] threat-website ebl update auto</code>	Sets the Zyxel Device to automatically check for updates to the URL Threat Filter external black list at the time and day specified. You should select a time when your network is not busy for  The [no] command disables the automatic updates.
<code>threat-website ebl update hourly</code>	Sets the Zyxel Device to automatically check for updates to the URL Threat Filter external black list once per day, at the specified hour.
<code>threat-website ebl update daily &lt;0..23&gt;</code>	Sets the Zyxel Device to update the URL Threat Filter external black list every day at the specified time. For example, the time format is the 24 hour clock, so '23' means 11 PM.
<code>threat-website ebl update weekly {sun /mon/tue/wed/thu/fri/sat} &lt;0..23&gt;</code>	Sets the Zyxel Device to automatically check for updates to the URL Threat Filter external black list file once per week, on the specified day at the specified hour.
<code>threat-website ebl update</code>	Checks for updates to the URL Threat Filter external black list file immediately.
<code>show threat-website ebl</code>	Shows all URL Threat Filter external black list profiles.
<code>show threat-website ebl &lt;profile name&gt;</code>	Shows the specified URL Threat Filter external black list profile.
<code>show threat-website ebl signature update</code>	Shows whether automatic external black list updates are enabled, and the schedule for the updates.
<code>show threat-website ebl &lt;1..4&gt; {date   number}</code>	Shows how many addresses are in the specified URL Threat Filter external black list profile, or the date that the external black list file was last updated.  The profile is identified by its ID number, which can be viewed by running the command <code>show threat-website ebl</code> .
<code>show threat-website search {ipv6address   ipv4address}</code>	Searches for the specified IPv4 or IPv6 address in the internal and external URL Threat Filter databases, and then displays the IP address's threat level.



### 40.3.3 Update URL Threat Filter Signatures

Use these commands to update new signatures. You must have already registered for the URL Threat Filter service.

Table 180 Update Signatures

COMMAND	DESCRIPTION
<code>anti-botnet update signatures</code>	Immediately downloads signatures from an update server.
<code>[no] anti-botnet update auto</code>	Enables (disables) automatic signature downloads at regular times and days.
<code>anti-botnet update daily &lt;0..23&gt;</code>	Enables automatic signature download every day at the time specified.
<code>anti-botnet update hourly</code>	Enables automatic signature download every hour.
<code>anti-botnet update weekly {sun   mon   tue   wed   thu   fri   sat} &lt;0..23&gt;</code>	Enables automatic signature download once-a-week at the time and day specified.
<code>show anti-botnet signature update</code>	Displays signature update schedule.
<code>show anti-botnet update status</code>	Displays signature update status.
<code>show security-service signature status</code>	Displays details about all current signature sets.

### 40.3.4 Update Signature Examples

These examples show how to enable/disable automatic URL Threat Filter signature downloading, schedule updates, display the schedule, display the update status, show the (new) updated signature version number and show the date/time the signatures were created.

```

Router# configure terminal
Router(config)# anti-botnet update signatures
Anti-Botnet signature update in progress.
Please check system log for more information.
Router(config)# anti-botnet update auto
Router(config)# no anti-botnet update auto
Router(config)# anti-botnet update hourly
Router(config)# anti-botnet update daily 10
Router(config)# anti-botnet update weekly fri 13
Router(config)# show anti-botnet signature update
auto: no
schedule: weekly at Friday 13 o'clock
Router(config)# show anti-botnet update status
current status: Botnet Filter signature download has failed. (failed) at Mon Jul 9
18:01:32 2018
last update time: 2018/07/09 18:01:32
Router(config)# show security-service signature status
Feature                Type                Current Version    Released Date
      Last Sync
=====
Anti-Malware           Anti-Malware Signature  1.0.0.000          2018-01-01 00:00:00
(UTC+08:00) 2018-07-08 23:26:01
Anti-Malware           Cloud Threat Database    1.0.0.20171211.1   2017-12-11 13:46:40
(UTC+08:00) 2018-07-08 23:26:01
App-Patrol             App-Patrol              1.0.0.20180125.0   2018-01-25 09:45:25
(UTC+08:00) 2018-07-08 00:46:01
IDP                    IDP                     3.1.4.050          2013-12-05 18:09:51
(UTC+08:00) 2018-07-08 01:11:01
Botnet Filter          Botnet Filter           1.0.0.000          2017-04-01 11:25:37
(UTC+08:00) 2018-07-09 18:01:19

```

### 40.3.5 URL Threat Filter Statistics

The following table describes the commands for collecting and displaying URL Threat Filter statistics. You must use the `configure terminal` command to enter the configuration mode before you can use these commands.

Table 181 Commands for URL Threat Filter Statistics

COMMAND	DESCRIPTION
[no] anti-botnet statistics collect	Turns the collection of URL Threat Filter IP blocking statistics on or off.
anti-botnet statistics flush	Clears the collected IP blocking statistics.
[no] threat-website statistics collect	Turns the collection of URL Threat Filter URL blocking statistics on or off.
threat-website statistics flush	Clears the collected URL blocking statistics.

Table 181 Commands for URL Threat Filter Statistics (continued)

COMMAND	DESCRIPTION
<code>show anti-botnet statistics summary</code>	Displays the collected URL Threat Filter IP blocking statistics.
<code>show anti-botnet statistics collect status</code>	Displays whether the collection of URL Threat Filter IP blocking statistics is turned on or off.
<code>show anti-botnet statistics recent-activities</code>	Displays a list of connection attempts to or from the URL Threat Filter IP addresses.
<code>show threat-website statistics collect</code>	Displays whether the collection of URL Threat Filter blocking statistics is turned on or off.
<code>show threat-website statistics list</code>	Displays a list of connection attempts to or from the web pages of the specified categories.
<code>show threat-website statistics summary</code>	Displays the collected URL Threat Filter blocking statistics.

### 40.3.6 URL Threat Filter Statistics Example

This example shows how to collect and display URL Threat Filter statistics.

```
Router(config)# anti-botnet statistics collect
Router(config)# show anti-botnet statistics collect status
Anti-BotNet Statistics Status: yes
duration: since 2018-07-09 17:38:15 to 2018-07-09 18:17:15
Router(config)# show anti-botnet statistics summary
enable: 1
scan: 0
total_threat: 0
high: 0
medium: 0
low: 0
Router(config)#
```

#### 40.3.6.1 Security Threat Category Definitions

The following table contains a list of URL Threat Filter (previously Anti-Botnet Filter) categories in firmware version 4.50 or earlier.

Table 182 Legacy Category Descriptions

CATEGORY	DESCRIPTION
Anonymizers	Sites and proxies that act as an intermediary for surfing to other Web sites in an anonymous fashion, whether to circumvent web filtering or for other reasons.
Botnets	A botnet is a network consisting of computers that are infected with malware and remotely controlled. The infected computers will contact and wait for instructions from a command and control (C&C) server. An attacker can control the botnet by setting up a C&C server and then sending commands to the infected computers. Alternatively, a peer-to-peer network approach is used. The infected computer scans and communicates with the peer devices in the same botnet to share commands or malware sent by the C&C server. These are botnet sites including command-and-control (C&C) servers

Table 182 Legacy Category Descriptions (continued)

Compromised	Sites that have been compromised by someone other than the site owner in order to install malicious programs without the user's knowledge. Includes sites that may be vulnerable to a particular high-risk attack.
Malware	Sites that install unwanted software on a user's computer with the intent to enable third-party monitoring or make system changes without the user's consent.
Phishing & Fraud	Sites that are used for deceptive or fraudulent purposes (e.g. phishing), such as stealing financial or other user account information. These sites are most often designed to appear as legitimate sites in order to mislead users into entering their credentials.
Spam Sites	Sites that have been promoted through spam techniques.

The following table contains a list of URL Threat Filter categories in firmware version 4.55 or later.

Table 183 Current Category Descriptions

CATEGORY	DESCRIPTION
Anonymizers	Sites and proxies that act as an intermediary for surfing to other Web sites in an anonymous fashion, whether to circumvent web filtering or for other reasons.
Browser Exploits	Sites that contain browser exploits. A browser exploit is any content that forces a web browser to perform operations that you do not explicitly intend.
Malicious Downloads	Sites that host files containing malicious content, such as viruses, spyware, rootkits, and ransomware.
Malicious Sites	Sites that install unwanted software on a user's computer with the intent to enable third-party monitoring or make system changes without the user's consent.
Phishing	Sites that are used for deceptive or fraudulent purposes (e.g. phishing), such as stealing financial or other user account information. These sites are most often designed to appear as legitimate sites in order to mislead users into entering their credentials.
Spam URLs	Sites that have been promoted through spam techniques.
Spyware Adware Keyloggers	<p>Sites that contain spyware, adware, or keyloggers.</p> <p>Spyware is a program installed on your computer, usually without your explicit knowledge, that captures and transmits personal information or Internet browsing habits and details to companies. Companies use this information to analyze browsing habits, to gather marketing data, and to sell your information to others.</p> <p>Key logger programs try to capture and steal your passwords and watch and record everything you do on your computer.</p> <p>Adware programs typically display blinking advertisements or pop-up windows when you perform a certain action. Adware programs are often installed in exchange for another service, such as the right to use a program without paying for it.</p>

## 40.4 DNS Threat Filter Commands

The following table describes general DNS Threat Filter commands. You must use the `configure terminal` command to enter the configuration mode before you can use these commands.

Table 184 DNS Threat Filter Commands

COMMAND	DESCRIPTION
<code>[no] dns-filter black-list activate</code>	Enables or disables the DNS Threat Filter black list.  The Zyxel Device treats all FQDNs in the blacklist as malicious, and applies DNS Threat Filter rules when they are queried.
<code>dns-filter black-list FQDN {activate deactivate}</code>	Activates or deactivates the specified Fully Qualified Domain Name (FQDN) in the DNS Threat Filter black list.  If the FQDN is not already in the black list, the Zyxel Device adds it.  FQDN example: <code>www.zyxel.com.tw</code>
<code>no dns-filter black-list FQDN</code>	Removes the specified Fully Qualified Domain Name (FQDN) from the DNS Threat Filter black list.
<code>dns-filter black-list replace &lt;1..256&gt; FQDN {activate deactivate}</code>	Replaces the Fully Qualified Domain Name (FQDN) of the specified entry with a new one in the DNS Threat Filter black list.
<code>[no] dns-filter drop-malform-packet activate</code>	Sets the Zyxel Device to drop a DNS query packet if the DNS query is invalid, or if the device cannot read the packet.  A DNS query is invalid under any of the following conditions: <ul style="list-style-type: none"> <li>• The number of entries in the DNS header question count field is 0</li> <li>• An error occurs while parsing the domain name in the question field</li> <li>• The length of the domain name exceeds 255 characters</li> </ul> Use the <code>[no]</code> command to allow malformed DNS packets to pass through the Zyxel Device.
<code>[no] dns-filter drop-malform-packet log</code>	Have the Zyxel Device log a DNS query if the DNS query packet is not a standard DNS query, or if the device cannot read the packet.  Use the <code>[no]</code> command to stop logging.
<code>dns-filter profile profilename</code>	Enter subcommand mode and edit the specified DNS Threat Filter configuration profile. If the profile does not currently exist, the Zyxel Device creates it.  Note: Only certain Zyxel Device models and firmware versions support multiple profiles in the Web Configurator. On Zyxel Devices that do not support multiple profiles, edit the profile named <b>default_profile</b> to change settings in the Web Configurator UI.
<code>action {pass redirect}</code>	Choose what the Zyxel Device does when it detects a malicious DNS query packet.  <i>pass</i> : Have the Zyxel Device allow the DNS query packet and not reply a DNS reply packet with a fake IP for it.  <i>redirect</i> : Have the Zyxel Device reply with a DNS reply packet containing a default or custom-defined IP address.  The default redirect IP is the IP address of the DNS Threat Filter server ( <code>dnsft.cloud.zyxel.com</code> ).
<code>[no] black-list activate</code>	Enables or disables the DNS Threat Filter black list for this profile.

Table 184 DNS Threat Filter Commands (continued)

COMMAND	DESCRIPTION
[no] category {anonymizers   phishing   browser-exploits   spam-urls   malicious-downloads   spyware-adware-keyloggers   malicious-sites}	The Zyxel Device considers DNS queries that match the specified category to be malicious.  The <i>no</i> command means the Zyxel Device ignores DNS queries that match the specified category.
description <i>description</i>	Sets a description for the profile. You can use up to 60 printable ASCII characters.
[no] description	Deletes the description for this profile.
[no] log	The Zyxel Device generates a log message when it detects a malicious DNS query packet.  The <i>no</i> command means the Zyxel Device does not generate a log message or alert when it detects a malicious DNS query packet.
log-alert	The Zyxel Device generates a log message and an alert when it detects a malicious DNS query packet.
[no] white-list activate	Enables or disables the DNS Threat Filter white list for this profile.
dns-filter rename <i>old_profile_name</i> <i>new_profile_name</i>	Renames the DNS Threat Filter profile.
dns-filter redirect-ip default	Sets the redirect IPv4 address for malicious DNS queries to the default, which is the IP address of the DNS Threat Filter server (dnsft.cloud.zyxel.com).  This setting is used when <code>dns-filter profile &gt; action</code> is set to <code>redirect</code> .
dns-filter redirect-ip custom <i>IPv4</i>	Sets the redirect IP address for malicious DNS queries to the specified IPv4 address.  This setting is used when <code>dns-filter profile &gt; action</code> is set to <code>redirect</code> .
[no] dns-filter statistics collect	Turns the collection of DNS Threat Filter blocking statistics on or off.
dns-filter statistics flush	Clears the collected IP blocking statistics.
[no] dns-filter white-list activate	Enables or disables the DNS Threat Filter white list.  The Zyxel Device treats all FQDNs in the white list as non-malicious, and does not apply DNS Threat Filter rules when they are queried.
dns-filter white-list <i>FQDN</i> {activate deactivate}	Activates or deactivates the specified Fully Qualified Domain Name (FQDN) in the DNS Threat Filter white list.  If the FQDN is not already in the white list, the Zyxel Device adds it.  FQDN example: www.zyxel.com.tw
no dns-filter white-list <i>FQDN</i>	Removes the specified Fully Qualified Domain Name (FQDN) from the DNS Threat Filter white list.
dns-filter white-list replace <1..256> <i>FQDN</i> {activate deactivate}	Replaces the Fully Qualified Domain Name (FQDN) of the specified entry with a new one in the DNS Threat Filter white list.
show dns-filter {white-list black-list}	Displays the current DNS Threat Filter white or black list.
show dns-filter dashboard statistics summary	Displays the total number of Fully Qualified Domain Names (FQDNs) that the Zyxel Device has scanned, and the number of malicious FQDNs detected, as displayed on the Web Configurator dashboard.

Table 184 DNS Threat Filter Commands (continued)

COMMAND	DESCRIPTION
<code>show dns-filter profile {all   profilename}</code>	Shows the name and settings of each DNS Threat Filter profiles, or the specified DNS Threat Filter profile.
<code>show dns-filter search FQDN</code>	Runs a DNS query for the specified Fully Qualified Domain Name (FQDN) and returns the result according to the current DNS Threat Filter rules.
<code>show dns-filter statistics collect</code>	Displays whether the collection of DNS Threat Filter statistics is turned on or off.
<code>show dns-filter statistics list</code>	Displays the collected DNS Threat Filter statistics.
<code>show dns-filter statistics summary</code>	Displays the total number of Fully Qualified Domain Names (FQDNs) that the Zyxel Device has scanned, and the number of malicious FQDNs detected.
<code>show dns-filter status</code>	Displays the action and log settings for the <code>dns-filter</code> service.
<code>[no] security-service dns-filter activate</code>	Turns on the DNS Threat Filter service on the Zyxel Device. The <code>no</code> command disables the DNS Threat Filter service.
<code>security-service dns-filter inspect {all-traffic   by-policy}</code>	Sets how the security service inspects traffic. <i>all-traffic</i> : The security service inspects all traffic passing through the Zyxel Device. <i>by-policy</i> : The security service inspects traffic only when its profile is bound to a security policy. For information on binding a security service profile to a security policy, see <a href="#">Section 29.2.1 on page 219</a> .
<code>show security-service status</code>	Displays whether the security services are enabled on the Zyxel Device.
<code>dns-filter fake-dns-response-ttl &lt;300...86400&gt;</code>	Sets the time period in seconds for redirecting clients to a default or custom-defined IP address when the clients try to access a blocked FQDN. If you remove an FQDN from the block list before the response time-to-live (TTL) time is up, the clients will still be redirected to a default or custom-defined IP address when they try to access the FQDN.
<code>show dns-filter fake-dns-response-ttl</code>	Displays how long the clients will be redirected to a default or custom-defined IP address when the clients try to access a blocked FQDN.

# CHAPTER 41

## Sandboxing

This chapter introduces and shows you how to configure sandboxing.

### 41.1 Sandboxing Overview

The Zyxel Device sandboxing is a security mechanism, which provides a safe environment to separate running programs from your network and host devices. Unknown or untrusted programs/codes are executed within an isolated virtual machine (VM) to monitor and analyze the zero-day malware and advanced persistent threats (APTs) that may evade the Zyxel Device protection, such as anti-malware. When a file with malicious or suspicious codes is detected, the Zyxel Device can take specific actions on the threats.

### 41.2 Sandbox Commands

The following table describes general sandbox commands. You must use the `configure terminal` command to enter the configuration mode before you can use these commands.

Table 185 Sandbox Commands

COMMAND	DESCRIPTION
<code>sandbox dashboard statistics flush</code>	Clears the collected sandboxing statistics displayed on the web GUI dashboard.
<code>sandbox file-scanning-log {log   log-alert   no}</code>	Generates a log, log and alert or neither (no) when a file is being scanned.
<code>sandbox file-send-log {log   log-alert   no}</code>	Generates a log, log and alert or neither (no) when a file is sent for sandboxing inspection.
<code>[no] sandbox file-type {archives   chm   eicar   executables   macromedia-flash-data   ms-office-document   pdf   rtf   unknown-type}</code>	Specifies the type of files to be sent for sandboxing inspection. The <code>no</code> command sets the Zyxel Device to not send the specified type of files for sandboxing inspection.
<code>sandbox malicious-action malicious {allow   destroy} {log   log-alert   no}</code>	Sets whether the Zyxel Device deletes ( <code>destroy</code> ) or forwards ( <code>allow</code> ) malicious files. This also sets the Zyxel Device to generate a log, log and alert or neither (no) when a malicious file is detected.
<code>sandbox malicious-action suspicious {allow   destroy} {log   log-alert   no}</code>	Sets whether the Zyxel Device deletes ( <code>destroy</code> ) or forwards ( <code>allow</code> ) suspicious files. This also sets the Zyxel Device to generate a log, log and alert or neither (no) when a suspicious file is detected.
<code>sandbox mdb flush</code>	Removes sandboxing MDB files.



Table 185 Sandbox Commands (continued)

COMMAND	DESCRIPTION
[no] sandbox queue-packet	Has the Zyxel Device hold the downloaded file for up to two seconds if the downloaded file has never been inspected before. The Zyxel Device will wait for the cloud server's result and forward the file in two seconds. Sandbox detection may take longer than two seconds, so infected files could still possibly be forwarded to the user.  The <code>no</code> command clears the setting.  Note: The Zyxel Device only checks the file types you specified for sandbox inspection. The scan result will be removed from the Zyxel Device cache after the Zyxel Device restarts.
sandbox response-clean-log {log   log-alert   no}	Generates a log, log and alert or neither (no) when no malicious or suspicious files are detected.
sandbox server-file {delete   keep}	The Zyxel Device tells the sandboxing host server to keep or delete a file after scanning it.  Note: This feature is deprecated.
[no] sandbox statistics collect	Turns the collection of sandboxing statistics on or off.
sandbox statistics flush	Clears the collected sandboxing statistics.
sandbox dashboard statistics flush	Clears the collected sandboxing statistics on the web GUI dashboard.
[no] security-service sandbox activate	Turns on sandboxing on the Zyxel Device.  The <code>no</code> command disables sandboxing.
show sandbox file-type all	Displays all the file types and whether a type of files is to be sent for sandboxing inspection.
show sandbox file-type status	Displays only the types of files that are set to be sent for sandboxing inspection.
show sandbox statistics collect	Displays whether the collection of sandboxing statistics is turned on or off.
show sandbox statistics ranking file-name	Queries and sorts the sandboxing statistics entries by file name.
show sandbox statistics summary	Displays the collected sandboxing statistics.
show sandbox statistics dashboard summary	Displays the collected sandboxing statistics that are currently displayed on the web GUI dashboard.
show sandbox status	Displays the action and log settings for sandboxing.
show security-service status	Displays whether the security services are enabled on the Zyxel Device.

## 41.2.1 Sandbox Command Examples

This command shows how to enable sandboxing on the Zyxel Device and displays the status of security services.

```
Router# configure terminal
Router(config)# security-service sandbox activate
Router(config)# show security-service status
ips activation: no
sandbox activation: yes
anti-virus activation: yes
anti-botnet-ip activation: no
anti-botnet-url activation: no
anti-spam activation: no
content-filter activation: yes
app-patrol activation: yes
Router(config)#
```

This command sets the Zyxel Device to delete malicious files and generate a log when a malicious file is detected.

```
Router# configure terminal
Router(config)# sandbox malicious-action malicious destroy log
Router(config)#
```

# CHAPTER 42

## IDP Commands

This chapter introduces IDP-related commands.

### 42.1 Overview

IDP (Intrusion Detection and Prevention) protects against network-based intrusions, by detecting malicious or suspicious packets and responding instantaneously.

The IDP commands mostly mirror web configurator features. It is recommended you use the web configurator for IDP features such as searching for web signatures, creating/editing an IDP profile or creating/editing a custom signature. Some web configurator terms may differ from the command-line equivalent.

#### Packet Inspection Signatures

A signature is a pattern of malicious or suspicious packet activity. You can specify an action to be taken if the system matches a stream of data to a malicious signature. You can change the action in the profile screens. Packet inspection examines OSI (Open System Interconnection) layer-4 to layer-7 packet contents for malicious data. Generally, packet inspection signatures are created for known attacks while anomaly detection looks for abnormal behavior.

#### Rate Based Signatures

Rate based signatures are IDP signatures that allow the Zyxel Device to just respond when a certain number of malicious packets are identified within a specific time.

**Figure 30** IDP Signatures Example

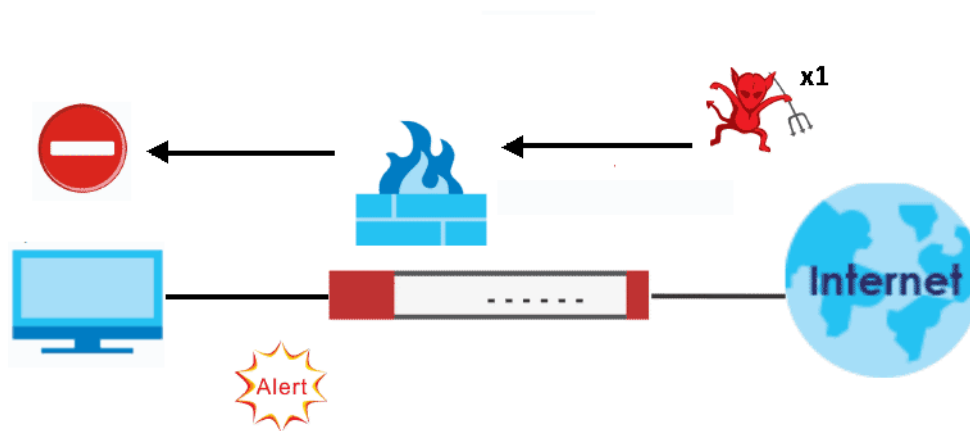
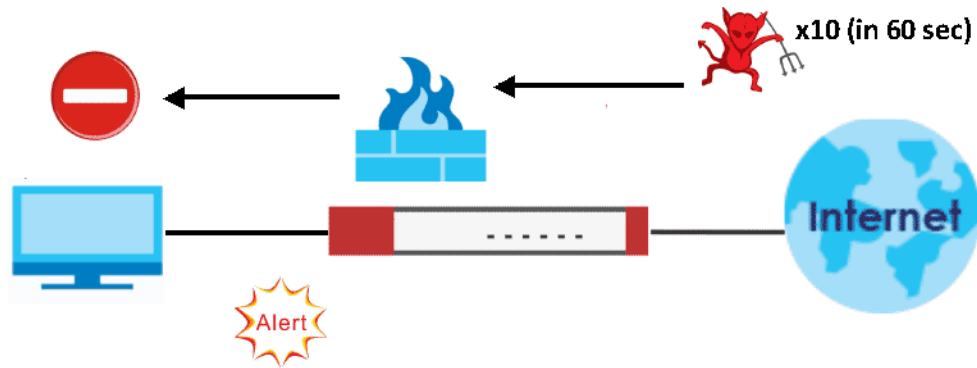

Figure 31 Rate Based Signatures Example



Note: The `no` command negates the action or returns it to the default value.

The following table lists valid input for IDP commands.

Table 186 Input Values for IDP Commands

LABEL	DESCRIPTION
<code>zone_profile</code>	The name of a zone. For some Zyxel Device models, use up to 31 characters (a-zA-Z0-9_). The name cannot start with a number. This value is case-sensitive.  For other Zyxel Device models, use pre-defined zone names like DMZ, LAN1, SSL VPN, IPsec VPN, OPT, and WAN.
<code>idp_profile</code>	The name of an IDP profile. It can consist of alphanumeric characters, the underscore, and the dash, and it is 1-31 characters long. Spaces are not allowed.

## 42.2 General IDP Commands

### 42.2.1 IDP Activation

Note: You must register for the IDP/AppPatrol signature service (at least the trial) before you can use it. See [Chapter 5 on page 52](#).

This table shows the IDP signature, and system-protect activation commands.

Table 187 IDP Activation

COMMAND	DESCRIPTION
<code>[no] security-service ips activate</code>	Turns on IDP on the Zyxel Device.  The <code>no</code> command disables IDP.
<code>show security-service status</code>	Displays whether the security services such as IDP are enabled on the Zyxel Device.

Table 187 IDP Activation

COMMAND	DESCRIPTION
<code>security-service ips inspect {all-traffic / by-policy}</code>	Sets how the security service inspects traffic.  <i>all-traffic</i> : The security service inspects all traffic passing through the Zyxel Device.  <i>by-policy</i> : The security service inspects traffic only when its profile is bound to a security policy.  For information on binding a security service profile to a security policy, see <a href="#">Section 29.2.1 on page 219</a> .
<code>[no] idp {anomaly   signature   system-protect} activate</code>	Enables IDP signatures, anomaly detection, and/or system-protect. IDP signatures use requires IDP service registration. If you don't have a standard license, you can register for a once-off trial one. The <code>no</code> command disables the specified service.
<code>idp system-protect deactivate</code>	Disables system-protect.
<code>show idp {anomaly   signature   system-protect} activation</code>	Displays the activation status of the anomaly detection, IDP signature, or system protect service.
<code>show idp rate_based_sig &lt;profile name&gt;</code>	Displays the specified rate based signature profile.
<code>idp reload</code>	Recovers the IDP signatures. You should only need to do this if instructed to do so by a support technician.
<code>idp session-block {activate   deactivate}</code>	Activate a specific RDP signature.  Note: This command is aimed at regular users. You should only use it if instructed to do so.
<code>idp session-block period {1-3600}</code>	Sets the time in seconds that the Zyxel Device blocks an IP address which matches the <code>idp session-block signature</code> .

### 42.2.1.1 Activate/Deactivate IDP Example

This example shows how to activate and deactivate signature-based IDP on the Zyxel Device.

```
Router# configure terminal
Router(config)# idp signature activate
Router(config)# show idp signature activation
idp signature activation: yes
Router(config)# no idp signature activate
Router(config)# show idp signature activation
idp signature activation: no
```

## 42.3 IDP Profile Commands

### 42.3.1 Global Profile Commands

Use these commands to rename or delete existing profiles and show IDP base profiles.

Table 188 Global Profile Commands

COMMAND	DESCRIPTION
<code>idp rename signature profile1 profile2</code>	Rename an IDP signature originally named <i>profile1</i> to <i>profile2</i> .
<code>no idp signature profile3</code>	Delete an IDP signature or system protect profile named <i>profile3</i> .
<code>idp signature profile signature sid {activate   log [alert]   action {drop   reject-sender   reject-receiver   reject-both}}</code>	Sets the action and log for the specified signature.
<code>idp signature mode {detection   prevention}</code>	Sets what the Zyxel Device does when a stream of data matches a malicious signature. <ul style="list-style-type: none"> <li><b>detection:</b> The Zyxel Device only creates a log message. The default IDP profile changes to default_detect_only.</li> <li><b>prevention:</b> The Zyxel Device performs a user-specified action. The default IDP profile changes to default_profile.</li> </ul>
<code>show idp signature profile signature all details</code>	Lists the settings for all of the specified profile's signatures. Use  more to display the settings page by page.
<code>show idp signature all details</code>	Lists the settings for all of the signatures. Use  more to display the settings page by page.
<code>show idp {signature   anomaly} base profile</code>	Displays all IDP signature or system protect base profiles.
<code>show idp signature base profile {all none wan lan dmz} settings</code>	Lists the specified signature base profile's settings. Use  more to display the settings page by page.
<code>show idp signature profiles</code>	Displays IDP profiles created.
<code>show idp signature mode</code>	Displays the IDP scan mode.
<code>show idp engine version</code>	Displays the IDP engine version.
<code>show idp signature profile signature sid details</code>	Displays specified signature details.

### 42.3.1.1 Example of Global Profile Commands

In this example we rename an IDP signature profile from "old\_profile" to "new\_profile", delete the "bye\_profile" and show all base profiles available.

```
Router# configure terminal
Router(config)# idp rename signature old_profile new_profile
Router(config)# no idp signature bye_profile
Router(config)# show idp signature base profile
No.  Base Profile Name
=====
1    none
2    all
3    wan
4    lan
5    dmz
Router(config)#
```

### 42.3.2 Editing/Creating IDP Signature Profiles

Use these commands to create a new IDP signature profile or edit an existing one. It is recommended you use the web configurator to create/edit profiles. If you do not specify a base profile, the default base profile is none.

Note: You cannot change the base profile later!

Table 189 Editing/Creating IDP Signature Profiles

COMMAND	DESCRIPTION
<code>idp signature newpro [base {all   lan   wan   dmz   none}]</code>	Creates a new IDP signature profile called <i>newpro</i> . <i>newpro</i> uses the base profile you specify. Enters sub-command mode. All the following commands relate to the new profile. Use <code>exit</code> to quit sub-command mode.
<code>[no] signature sid activate</code>	Activates or deactivates an IDP signature.
<code>signature sid log [alert]</code>	Sets log or alert options for an IDP signature
<code>no signature sid log</code>	Deactivates log options for an IDP signature
<code>signature sid action {drop   reject-sender   reject-receiver   reject-both}</code>	Sets an action for an IDP signature
<code>no signature sid action</code>	Deactivates an action for an IDP signature.
<code>description description2</code>	Describes the signature profile.

### 42.3.3 Editing Rate Based Signatures Profiles

IDP signatures identify traffic packets with suspicious malicious patterns. The Zyxel Device can then respond instantaneously according to the action you define. If you do not want the Zyxel Device to respond instantaneously for each suspicious packet detected, use rate based signatures.

Use these commands to edit rate based signatures profiles. It is recommended you use the web configurator to create/edit profiles. You must use the `configure terminal` commands to enter the configuration mode before you can use the configuration commands.

Table 190 Editing Rate Based Signatures Profiles

COMMAND	DESCRIPTION
<code>idp signature default_profile</code>	Enters configuration mode for the rate based signatures default profiles.
<code>signature sid seconds</code>	Sets the length of time in seconds the event should occur from a client the counts number of times to trigger an action.  For example, counts is set to 5, and seconds is set to 60. If the Zyxel Device detects 5 or more occurrences of malicious traffic in less than 60 seconds, then action is triggered.
<code>signature sid counts</code>	Sets the number of security events that need to occur within the defined seconds to trigger an action.
<code>signature sid block_period</code>	Sets the time period the attacker's IP will be blocked.
<code>signature sid action {drop   reject-sender   reject-receiver   reject-both}</code>	Sets an action for a rate based signature.
<code>no signature sid action</code>	Deactivates an action for a rate based signature.

### 42.3.3.1 IDP Rate-Based Signature Example

This example shows how to configure a rate-based signature settings.

```
Router# configure terminal
Router(config)# idp signature default_profile
Router(config-idp-signature-profile-default_profile)# signature 130009
action activate block_period counts log
seconds
Router(config-idp-signature-profile-default_profile)# signature 130009
seconds
<1..120>
Router(config-idp-signature-profile-default_profile)# signature 130009
seconds 60
Router(config-idp-signature-profile-default_profile)# signature 130009
counts
<1..300>
Router(config-idp-signature-profile-default_profile)# signature 130009
counts 250
Router(config-idp-signature-profile-default_profile)# signature 130009
block_period
<0..86400>
Router(config-idp-signature-profile-default_profile)# signature 130009
block_period 500
Router(config-idp-signature-profile-default_profile)# signature 130009
action
drop reject-both reject-receiver reject-sender
Router(config-idp-signature-profile-default_profile)# signature 130009
action drop
```



## 42.3.4 Signature Search

Use this command to search for signatures in the named profile.

Note: It is recommended you use the web configurator to search for signatures.

Table 191 Signature Search Command

COMMAND	DESCRIPTION
<pre>idp search signature <i>my_profile</i> name <i>quoted_string</i> sid SID severity <i>severity_mask</i> platform <i>platform_mask</i> classtype <i>classtype_mask</i> service <i>service_mask</i> activate {any   yes   no} log {any   no   log   log-alert} action <i>action_mask</i></pre>	<p>Searches for signature(s) in a profile by the parameters specified. The quoted string is any text within the signature name in quotes, for example, [idp search LAN_IDP name "WORM" sid 0 severity 0 platform 0 classtype 0 service 0 activate any log any action] searches for all signatures in the LAN_IDP profile containing the text "worm" within the signature name.</p>
<pre>show idp search signature <i>my_profile</i> name <i>quoted_string</i> sid SID severity <i>severity_mask</i> platform <i>platform_mask</i> classtype <i>classtype_mask</i> service <i>service_mask</i> activate {any   yes   no} log {any   no   log   log-alert} action <i>action_mask</i></pre>	<p>Searches for signature(s) in a profile by the parameters specified. The quoted string is any text within the signature name in quotes, for example, [idp search LAN_IDP name "WORM" sid 0 severity 0 platform 0 classtype 0 service 0 activate any log any action] searches for all signatures in the LAN_IDP profile containing the text "worm" within the signature name.</p>

### 42.3.4.1 Search Parameter Tables

The following table displays the command line severity, platform and class type equivalent values. If you want to combine platforms in a search, then add their respective numbers together. For example, to search for signatures for Windows NT, Windows XP and Windows 2000 computers, then type "12" as the platform parameter.

Table 192 Severity, Platform and Class Type Command Values

SEVERITY	PLATFORM	CLASS TYPE
1 = Very Low	1 = All	1 = DoS
2 = Low	2 = Win95/98	2 = Buffer-Overflow
3 = Medium	4 = WinNT	3 = Access-Control
4 = High	8 = WinXP/2000	4 = Scan
5 = Severe	16 = Linux	5 = Backdoor/Trojan
	32 = FreeBSD	6 = Others
	64 = Solaris	7 = P2P
	128 = SGI	8 = IM
	256 = Other-Unix	9 = Virtus/Worm
	512 = Network-Device	10 = Botnet
		11 = Web-Attack
		12 = Spam

The following table displays the command line service and action equivalent values. If you want to combine services in a search, then add their respective numbers together. For example, to search for signatures for DNS, Finger and FTP services, then type "7" as the service parameter.

Table 193 Service and Action Command Values

SERVICE	SERVICE	ACTION
1 = DNS	65536 = SMTP	1 = None
2 = FINGER	131072 = SNMP	2 = Drop
4 = FTP	262144 = SQL	4 = Reject-sender
8 = MYSQL	524288 = TELNET	8 = Reject-receiver
16 = ICMP	1048576 = TFTP	16 = Reject-both
32 = IM	2097152 = n/a	
64 = IMAP	4194304 = WEB_ATTACKS	
128 = MISC	8388608 = WEB_CGI	
256 = NETBIOS	16777216 = WEB_FRONTPAGE	
512 = NNTP	33554432 = WEB_IIS	
1024 = ORACLE	67108864 = WEB_MISC	
2048 = P2P	134217728 = WEB_PHP	
4096 = POP2	268435456 = MISC_BACKDOOR	
8192 = POP3	536870912 = MISC_DDOS	
16384 = RPC	1073741824 = MISC_EXPLOIT	
32768 = RSERVICES		

#### 42.3.4.2 Signature Search Example

This example command searches for all signatures in the LAN\_IDP profile:

- Containing the text "worm" within the signature name
- With an ID of 12345
- Has a very low severity level
- Operates on the Windows NT platform
- Is of class type: DNS service
- Is enabled
- Generates logs.

```
Router# configure terminal
Router(config)#
Router(config)# idp search signature LAN_IDP name "worm" sid 12345 severity
1 platform 4 type 4 service 1 activate yes log log action 2
```

## 42.4 IDP Custom Signatures

Use these commands to create a new signature or edit an existing one.

Note: It is recommended you use the web configurator to create/edit signatures using the web configurator **Anti-X > UTM Profile > Custom Signatures** screen.

Note: You must use the web configurator to import a custom signature file.

Table 194 Custom Signatures

COMMAND	DESCRIPTION
<code>idp customize signature <i>quoted_string</i></code>	Create a new custom signature. The quoted string is the signature command string enclosed in quotes. for example. "alert tcp any any <> any any (msg: \"test\"; sid: 9000000 ; )".
<code>idp customize signature edit <i>quoted_string</i></code>	Edits an existing custom signature.
<code>no idp customize signature <i>custom_sid</i></code>	Deletes a custom signature.
<code>idp customize_import name <i>sig_name</i></code>	Edits an existing signature.
<code>show idp signatures custom-signature <i>custom_sid</i> {details   contents   non-contents}</code>	Displays custom signature information.
<code>show idp signatures custom-signature all details</code>	Displays all custom signatures' information.
<code>show idp signatures custom-signature number</code>	Displays the total number of custom signatures.

## 42.4.1 Custom Signature Examples

These examples show how to create a custom signature, edit one, display details of one, all and show the total number of custom signatures.

```
Router# configure terminal
Router(config)# idp customize signature "alert tcp any any <> any any
(msg: \"test\"; sid: 9000000 ; )"
sid: 9000000
  message: test
  class type:
  severity:
  platform:
    all: no
    Win95/98: no
    WinNT: no
    WinXP/2000: no
    Linux: no
    FreeBSD: no
    Solaris: no
    SGI: no
    other-Unix: no
    network-device: no
  service:
  outbreak: no
```

This example shows you how to edit a custom signature.

```
Router(config)# idp customize signature edit "alert tcp any any <> any any
(msg : \"test edit\"; sid: 9000000 ; )"
sid: 9000000
  message: test edit
  class type:
  severity:
  platform:
    all: no
    Win95/98: no
    WinNT: no
    WinXP/2000: no
    Linux: no
    FreeBSD: no
    Solaris: no
    SGI: no
    other-Unix: no
    network-device: no
  service:
  outbreak: no
```

This example shows you how to display custom signature details.

```
Router(config)# show idp signatures custom-signature 9000000 details
sid: 9000000
  message: test edit
  class type:
  severity:
  platform:
    all: no
    Win95/98: no
    WinNT: no
    WinXP/2000: no
    Linux: no
    FreeBSD: no
    Solaris: no
    SGI: no
    other-Unix: no
    network-device: no
  service:
  outbreak: no
```

This example shows you how to display custom signature contents.

```
Router(config)# show idp signatures custom-signature 9000000 contents
sid: 9000000
Router(config)# show idp signatures custom-signature 9000000 non-contents
sid: 9000000
  ack:
  dport: 0
  dsize:
  dsize_rel:
  flow_direction:
  flow_state:
  flow_stream:
  fragbits_reserve:
  fragbits_dontfrag:
  fragbits_morefrag:
  fragoffset:
  fragoffset_rel:
  icmp_id:
  icmp_seq:
  icode:
  icode_rel:
  id:
  ipopt:
  itype:
  itype_rel:
  sameip:
  seq:
  sport: 0
  tcp_flag_ack:
  tcp_flag_fin:
  tcp_flag_push:
  tcp_flag_r1:
  tcp_flag_r2:
  tcp_flag_rst:
  tcp_flag_syn:
  tcp_flag_urg:
  threshold_type:
  threshold_track:
  threshold_count:
  threshold_second:
  tos:
  tos_rel:
  transport: tcp
  ttl:
  ttl_rel:
  window:
  window_rel:
```

This example shows you how to display all details of a custom signature.

```
Router(config)# show idp signatures custom-signature all details
sid: 9000000
  message: test edit
  class type:
  severity:
  platform:
    all: no
    Win95/98: no
    WinNT: no
    WinXP/2000: no
    Linux: no
    FreeBSD: no
    Solaris: no
    SGI: no
    other-Unix: no
    network-device: no
  service:
  outbreak: no
```

This example shows you how to display the number of custom signatures on the Zyxel Device.

```
Router(config)# show idp signatures custom-signature number
signatures: 1
```

## 42.5 Update IDP Signatures

Use these commands to update new signatures. You register for IDP service before you can update IDP signatures, although you do not have to register in order to update system-protect signatures.

Note: You must use the web configurator to import a custom signature file.

Table 195 Update Signatures

COMMAND	DESCRIPTION
<code>idp signature update signatures</code>	Immediately downloads IDP signatures from an update server.
<code>[no] idp signature update auto</code>	Enables (disables) automatic signature downloads at regular times and days.
<code>idp signature update hourly</code>	Enables automatic signature download every hour.
<code>idp signature update daily &lt;0..23&gt;</code>	Enables automatic signature download every day at the time specified.
<code>idp signature update weekly {sun   mon   tue   wed   thu   fri   sat} &lt;0..23&gt;</code>	Enables automatic signature download once-a-week at the time and day specified.
<code>show idp signature update</code>	Displays signature update schedule.
<code>show idp signature update status</code>	Displays signature update status.
<code>show idp signature signatures {version   date   number}</code>	Displays signature information

Table 195 Update Signatures

COMMAND	DESCRIPTION
<code>show idp signatures date</code>	Displays the date and time the signature set was released.
<code>show idp signatures number</code>	Displays the number of signatures in this set.
<code>show idp signatures version</code>	Displays the signature set version number currently used by the Zyxel Device. This number gets larger as new signatures are added.

## 42.5.1 Update Signature Examples

These examples show how to enable/disable automatic IDP downloading, schedule updates, display the schedule, display the update status, show the (new) updated signature version number, show the total number of signatures and show the date/time the signatures were created.

```
Router# configure terminal
Router(config)# idp signature update signatures
IDP signature update in progress.
Please check system log for future information.
Router(config)# idp signature update auto
Router(config)# no idp signature update auto
Router(config)# idp signature update hourly
Router(config)# idp signature update daily 10
Router(config)# idp signature update weekly fri 13
Router(config)# show idp signature update
auto: yes
schedule: weekly at Friday 13 o'clock
Router(config)# show idp signature update status
current status: IDP signature download failed, do 1 retry at Sat Jan  4
22:47:47 2003
last update time: 2003-01-01 01:34:39
Router(config)# show idp signature signatures version
version: 1.2000
Router(config)# show idp signature signatures number
signatures: 2000
Router(config)# show idp signature signatures date
date: 2005/11/13 13:56:03
```

## 42.6 IDP Statistics

The following table describes the commands for collecting and displaying IDP statistics. You must use the `configure terminal` command to enter the configuration mode before you can use these commands.

Table 196 Commands for IDP Statistics

COMMAND	DESCRIPTION
<code>[no] idp statistics collect</code>	Turn the collection of IDP statistics on or off.
<code>idp statistics flush</code>	Clears the collected statistics.

Table 196 Commands for IDP Statistics (continued)

COMMAND	DESCRIPTION
show idp statistics summary	Displays the collected statistics.
show idp statistics collect	Displays whether the collection of IDP statistics is turned on or off.
show idp statistics collect status	Displays the status of collected statistics.
show idp statistics ranking {signature-name   source   source6   destination   destination6   rate-based}	<p>Query and sort the IDP statistics entries by signature name, source IP address, or destination IP address.</p> <p><i>signature-name</i>: lists the most commonly detected signatures.</p> <p><i>source (6)</i>: lists the source IP addresses (IPv4 or IPv6) from which the Zyxel Device has detected the most intrusion attempts.</p> <p><i>destination (6)</i>: lists the most common destination IP addresses (IPv4 or IPv6) for detected intrusion attempts.</p> <p><i>rate-based</i>: lists the detected rate based signatures.</p>



## 42.6.1 IDP Statistics Example

This example shows how to collect and display IDP statistics. It also shows how to sort the display by the most common signature name, source IP address, or destination IP address.

```
Router# configure terminal
Router(config)# idp statistics collect
Router(config)# no idp statistics activate
Router(config)# idp statistics flush
Router(config)# show idp statistics collect status
IDP collect statistics status: yes
Router(config)# show idp statistics summary
scanned session : 268
packet dropped: 0
packet reset: 0
Router(config)# show idp statistics ranking signature-name
ranking: 1
  signature id: 8003796
  signature name: ICMP L3retriever Ping
  type: Scan
  severity: verylow
  occurrence: 22
ranking: 2
  signature id: 8003992
  signature name: ICMP Large ICMP Packet
  type: DDOS
  severity: verylow
  occurrence: 4
Router(config)# show idp statistics ranking destination
ranking: 1
  destination ip: 172.23.5.19
  occurrence: 22
ranking: 2
  destination ip: 172.23.5.1
  occurrence: 4
Router(config)# show idp statistics ranking source
ranking: 1
  source ip: 192.168.1.34
  occurrence: 26
```

## 42.7 IDP White List

The Zyxel Device will exclude the incoming packets of the signature(s) in the IDP white list. These packets won't be intercepted and will be passed through uninspected.

You must use the `configure terminal` command to enter the configuration mode before you can use these commands.

Table 197 Commands for IDP White List

COMMAND	DESCRIPTION
<code>idp white-list</code>	Enter IDP white list sub-command mode.
<code>[no] sid {1-4294967295}</code>	Adds the specified signature to the IDP white list. The <code>no</code> command removes the specified signature from the IDP white list.
<code>exit</code>	Exit IDP white list sub-command mode.
<code>show idp white-list</code>	Displays all signatures in the IDP white list.

## 42.8 IDP Packet Capture

The following table describes the commands for configuring IDP packet capture settings. Use IDP packet capture to capture network traffic that triggers IDP signatures.

Table 198 Commands for IDP Statistics

COMMAND	DESCRIPTION
<code>idp packet-capture {enable   disable}</code>	Enables or disables IDP packet capture.
<code>idp packet-capture show status</code>	Displays current IDP packet capture settings.
<code>idp packet-capture select {enable   disable}</code>	Captures network traffic that triggers the specified IDP signatures.
<code>idp packet-capture select {add-id sid   del-id sid}</code>	Captures network traffic that triggers the specified IDP signature. You can select up to 10 signature SIDs. Use the <code>del</code> command to stop the Zyxel Device from capturing network traffic that triggers the specified signature.
<code>idp packet-capture default setting</code>	Returns IDP packet capture settings to factory defaults. This command will: <ul style="list-style-type: none"> <li>• Enable IDP packet capture.</li> <li>• Disable IDP packet capture select.</li> <li>• Clear all selected signature SIDs.</li> </ul>

## 42.8.1 IDP Packet Capture Example

This example shows how to capture network traffic that triggers the specified IDP signature.

```
Router# idp packet-capture enable
Router# idp packet-capture select enable
Router# idp packet-capture select add-id
<0..4294967295>
Router# idp packet-capture select add-id 12345
Router# idp packet-capture show status
ips pkt capture status info:
  enable: 1
  user select sig_id enable: 1
-----
  current pkt count: 0
  current sig count: 0
  current session count: 0
  current mem size: 0
  current file size: 0
-----
  user select sig id count: 1
  12345,
```

This example shows how to return IDP packet capture settings to factory defaults.

```
Router# idp packet-capture default setting
Router# idp packet-capture
default  disable  enable  select  show
Router# idp packet-capture show status
ips pkt capture status info:
  enable: 1
  user select sig_id enable: 0
-----
  current pkt count: 0
  current sig count: 0
  current session count: 0
  current mem size: 0
  current file size: 0
-----
  user select sig id count: 0
```

# CHAPTER 43

# Content Filtering

This chapter covers how to use the content filtering feature to control web access.

## 43.1 Content Filtering Overview

Content filtering allows you to block certain web features, such as cookies, and/or block access to specific web sites. It can also block access to specific categories of web site content. You can create different content filtering policies for different addresses, schedules, users or groups and content filtering profiles. For example, you can configure one policy that blocks John Doe's access to arts and entertainment web pages during the workday and another policy that lets him access them after work.

### 43.1.1 Web Content Filter

The Web Content Filter allows the Zyxel Device to block specific web features, such as cookies or ActiveX, by inspecting the web pages that users are visiting. The Zyxel Device can also block access to specific websites, by inspecting the URL or Server Name Indication (SNI) that the user's web browser sends to the web server.

#### 43.1.1.1 Web Content Filter Process

- 1 A user enters a URL into their web browser.
- 2 The user's computer sends a DNS query for the URL.
- 3 DNS server returns an IP address for the URL.
- 4 The user's web browser connects to the IP address.
- 5 The Web Content Filter detects an HTTP connection, and inspects the website send using Server Name Indication (SNI).
- 6 If the website contains prohibited material, the HTTP request is redirected to a block page.

Note: If the user's web browser is using encryption, then you must enable SSL Inspection for Web Content Filter to work.

If the user's web browser is using Encrypted Server Name Indication (ESNI), DNS Content Filter will not work.

### 43.1.2 DNS Content Filter

The DNS Content Filter allows the Zyxel Device to block access to specific websites by inspecting DNS queries made by users on your network. If the website in the DNS query contains prohibited material,

then the Zyxel Device replies to the DNS query with a IP address that points to the block page. Unlike the Web Content Filter, the DNS Content Filter works if the user is using TLS 1.3 with ESNI.

### 43.1.2.1 DNS Content Filter Process

- 1 A user enters a URL into their web browser.
- 2 The user's computer sends a DNS query for the URL.
- 3 The DNS Content Filter detects DNS query, and inspects the website in the DNS query packet.
- 4 If website contains prohibited material, the DNS reply is redirected to a block page.

## 43.2 External Web Filtering Service

When you register for and enable the external web filtering service, your Zyxel Device accesses an external database that has millions of web sites categorized based on content. You can have the Zyxel Device block, block and/or log access to web sites based on these categories.

See the web configurator User's Guide to see how to view content filtering reports after you have activated the category-based content filtering subscription service.

Table 199 content-filter Report Commands

COMMAND	DESCRIPTION
<code>content-filter report deactivate</code>	Sets the message to display when content filtering blocks access to a web page. The <code>no</code> command clears the setting.
<code>content-filter report server {ip_address   hostname}</code>	Sets the URL of the web page to which to send users when their web access is blocked by content filtering. The <code>no</code> command clears the setting.

## 43.3 Content Filter Command Input Values

The following table explains the values you can input with the `content-filter` and `dns-content-filter` commands.

Table 200 Content Filter Command Input Values

LABEL	DESCRIPTION
<i>filtering_profile</i>	The filtering profile defines how to filter web URLs or content. You may use 1-31 alphanumeric characters, underscores( <code>_</code> ), or dashes ( <code>-</code> ), but the first character cannot be a number. This value is case-sensitive.
<i>category_name</i>	<p>The name of a web category. For a list of category definitions, see <a href="#">Section 43.7 on page 372</a>.</p> <p>Firmware v4.50 or earlier:</p> <p>{advertisements-pop-ups   job-search   alcohol-tobacco   leisure-recreation   anonymizers   malware   arts   network-errors   botnets   news   business   non-profits-ngos   chat   nudity   child-abuse-images   parked-domains   compromised   peer-to-peer   computers-technology   personal-sites   criminal-activity   phishing-fraud   cults   politics   dating-personals   pornography-sexually-explicit   download-sites   private-ip-addresses   education   real-estate   entertainment   religion   fashion-beauty   restaurants-dining   finance   school-cheating   forums-newsgroups   search-engines-portals   gambling   sex-education   games   shopping   general   social-networking   government   spam-sites   greeting-cards   sports   hacking   streaming-media-downloads   hate-intolerance   tasteless   health-medicine   translators   illegal-drugs   transportation   illegal-software   travel   image-sharing   violence   information-security   weapons   instant-messaging   web-based-email }</p> <p>Firmware v4.55 or later:</p> <p>{adult-topics   alcohol   anonymizing-utilities   art-culture-heritage   auctions-classifieds   blogs-wiki   business   chat   computing-internet   consumer-protection   content-server   controversial-opinions   cult-occult   dating-personals   dating-social-networking   digital-postcards   discrimination   drugs   education-reference   entertainment   extreme   fashion-beauty   finance-banking   for-kids   forum-bulletin-boards   gambling   gambling-related   game-cartoon-violence   games   general-news   government-military   gruesome-content   health   historical-revisionism   history   humor-comics   illegal-uk   incidental-nudity   information-security   information-security-new   instant-messaging   interactive-web-applications   internet-radio-tv   internet-services   job-search   major-global-religions   marketing-merchandising   media-downloads   media-sharing   messaging   mobile-phone   moderated   motor-vehicles   non-profit-advocacy-ngo   nudity   online-shopping   p2p-file-sharing   parked-domain   personal-network-storage   personal-pages   pharmacy   politics-opinion   pornography   portal-sites   potential-criminal-activities   potential-hacking-computer-crime   potential-illegal-software   private-ip-addresses   profanity   professional-networking   provocative-attire   public-information   pups   real-estate   recreation-hobbies   religion-ideology   remote-access   reserved   residential-ip-addresses   resource-sharing   restaurants   school-cheating-information   search-engines   sexual-materials   shareware-freeware   social-networking   software-hardware   sports   stock-trading   streaming-media   technical-business-forums   technical-information   text-spoken-only   text-translators   tobacco   travel   usenet-news   violence   visual-search-engine   weapons   web-ads   web-mail   web-meetings   web-phone}</p>



Table 200 Content Filter Command Input Values (continued)

LABEL	DESCRIPTION
<code>redirect_url</code>	The URL of the web page to which you want to send users when their web access is blocked by content filtering. The web page you specify here opens in a new frame below the denied access message.  Use "http://" followed by up to 255 characters (0-9a-zA-Z/?:@&=+\$\.-!~*') in quotes. For example, "http://192.168.1.17/blocked access".  IPv6 format support: http://[2001::1]/blocked_access
<code>service_timeout</code>	The value specifies the maximum querying time in seconds <1..60>
<code>url</code>	The URL of a web site in http://xxx.xxx.xxx format.
<code>query_timeout</code>	The value specifies the maximum querying time when testing the connection to an external content filtering server or checking its rating for a URL. <1..60> seconds.

## 43.4 Web Content Filter

The following section describes the commands for the web content filter.

### 43.4.1 General Web Content Filter Commands

The following table lists the commands that you can use for general web content filter configuration, such as creating a denial of access message or specifying a redirect URL and checking your external web filtering service registration status. Use the `configure terminal` command to enter the configuration mode to be able to use these commands. See [Table 200 on page 358](#) for details about the values you can input with these commands.

Table 201 content-filter General Commands

COMMAND	DESCRIPTION
<code>[no] content-filter block message message</code>	Sets the message to display when the Web Content Filter blocks access to a web page. The <code>no</code> command clears the setting.
<code>[no] content-filter block redirect redirect_url</code>	Sets the URL of the web page to which to send users when their web access is blocked by the Web Content Filter. The <code>no</code> command clears the setting.
<code>content-filter passed warning flush</code>	Clears the Zyxel Device's record of sessions for which it has given the user a warning before allowing access.
<code>content-filter passed warning timeout &lt;1..1440&gt;</code>	Sets how long to keep records of sessions for which the Zyxel Device has given the user a warning before allowing access.
<code>content-filter url-cache clear</code>	Clears all URLs from the Zyxel Device's local Web Content Filter cache.
<code>content-filter url-cache clear url</code>	Deletes the specified URL from the Zyxel Device's local Web Content Filter cache.
<code>content-filter url-server test commtouch</code>	Firmware v4.50 or earlier  Enters the sub-command mode for testing URLs with the legacy external Web Content Filter.



Table 201 content-filter General Commands (continued)

COMMAND	DESCRIPTION
<code>content-filter url-server test</code>	Firmware v4.55 or later Enters the sub-command mode for testing URLs with the Web Content Filter.
<code>url [timeout query_timeout]</code>	Checks which Web Content Filter category a web page belongs to. Enter the page's full URL including the protocol, for example: <code>http://www.zyxel.com.tw</code> .  The query fails if the content filter is not active.  <code>timeout</code> : Specify how long to wait for a response from the Web Content Filter server, in seconds.
<code>exit</code>	Leaves the sub-command mode.
<code>content-filter common-list {trust forbid}</code>	Enters the sub-command for configuring a common list of trusted or forbidden web sites.  The Web Content Filter profile commands let you configure trusted or forbidden URLs for individual profiles. URL checking is applied in the following order: profile trusted web sites, common trusted web sites, profile forbidden web sites, common forbidden web sites, and then profile keywords.
<code>[no] {ipv4   ipv4_cidr   ipv4_range   wildcard_domainname   tld   ipv6   ipv6_range   ipv6_prefix }</code>	Adds or removes a common trusted or forbidden web site entry.  <code>ipv4</code> : IPv4 address <W.X.Y.Z> <ul style="list-style-type: none"><li><code>ipv4_cidr</code>: IPv4 subnet in CIDR format, i.e. <code>192.168.1.0/32 &lt;W.X.Y.Z&gt;/&lt;1..32&gt;</code></li></ul> <code>ipv4_range</code> : Range of IPv4 addresses. <W.X.Y.Z>-<W.X.Y.Z>  <code>wildcard_domainname</code> : Wildcard domain name, in the format <code>String1.String2</code> . For example: <code>zyxel*.co*</code> <ul style="list-style-type: none"><li>String 1 must consist of 1–63 characters, and may include letters, numbers, and the following special characters: - (hyphen), . (period), * (wildcard character).</li><li>String 2 must consist of 1–63 characters, and may include letters, numbers, and the following special characters: - (hyphen), * (wildcard character).</li></ul> <code>tld</code> : top level domain.  <code>ipv6</code> : IPv6 address, i.e. <code>2001::1</code>  <code>ipv6_range</code> : Range of IPv6 address, <IPv6 Address >-<IPv6 Address >  <code>ipv6_prefix</code> : IPv6 prefix formant, <IPv6 Address>/<Prefix Length>
<code>exit</code>	Leaves the sub-command mode.
<code>content-filter cf-queue flush</code>	Clears content filter queuing packets.
<code>[no] content-filter https-domain-filter activate</code>	Enables HTTPS Domain Filter which lets the ZyWALL/USG take action on HTTPS web pages using the category service. In an HTTPS connection, the Zyxel Device can extract the Server Name Indication (SNI) from a client request, check if it matches a category in the Web Content Filter and then take appropriate action. The keyword match is for the domain name only.  The <code>no</code> command disables the HTTPS Domain Filter.

Table 201 content-filter General Commands (continued)

COMMAND	DESCRIPTION
<code>show content-filter passed warning</code>	Displays the Zyxel Device's record of sessions for which it has given the user a warning before allowing access.
<code>show content-filter settings</code>	Displays the general content filtering settings.
<code>show content-filter common-list {trust forbid}</code>	Displays the common list of trusted or forbidden web sites.
<code>show content-filter https-domain-filter status</code>	Displays HTTPS Domain Filter content filtering settings.
<code>[no] content-filter sslv3 action block</code>	Block HTTPS web pages that are using SSL version 3 or earlier.

## 43.4.2 Web Content Filter Profile Commands

The following table lists the commands that you can use to configure a web content filter profile. Use the `configure terminal` command to enter the configuration mode to be able to use these commands. See [Table 200 on page 358](#) for details about the values you can input with these commands.

Table 202 content-filter Filtering Profile Commands Summary

COMMAND	DESCRIPTION
<code>[no] content-filter profile <i>filtering_profile</i></code>	Creates a Web Content Filter profile. The <code>no</code> command removes the profile.
<code>[no] content-filter profile <i>filtering_profile</i> url-server</code>	Enables the Content Filter Category Service for this profile. The <code>no</code> command disables the service.
<code>[no] content-filter profile <i>filtering_profile</i> custom</code>	Sets a Web Content Filter profile to use a profile's custom settings (lists of trusted web sites and forbidden web sites and blocking of certain web features). The <code>no</code> command has the profile not use the custom settings.
<code>[no] content-filter profile <i>filtering_profile</i> custom activex</code>	Sets a Web Content Filter profile to block ActiveX controls. The <code>no</code> command sets the profile to allow ActiveX.
<code>[no] content-filter profile <i>filtering_profile</i> custom cookie</code>	Sets a Web Content Filter profile to block Cookies. The <code>no</code> command sets the profile to allow Cookies.
<code>content-filter profile <i>filtering_profile</i> custom-list forbid</code>	Enters the sub-command for configuring the Web Content Filter profile's list of forbidden hosts.
<code>[no] <i>forbid_hosts</i></code>	Adds a forbidden host to the Web Content Filter profile's list. The <code>no</code> command removes it.
<code>exit</code>	Leaves the sub-command mode.
<code>[no] content-filter profile <i>filtering_profile</i> custom java</code>	Sets a Web Content Filter profile to block Java. The <code>no</code> command sets the profile to allow Java.
<code>content-filter profile <i>filtering_profile</i> custom-list keyword</code>	Enters the sub-command for configuring the Web Content Filter profile's list of forbidden keywords. This has the content filtering profile block access to Web sites with URLs that contain the specified keyword or IP address in the URL.
<code>[no] <i>keyword</i></code>	Adds a forbidden keyword or IP address to the Web Content Filter profile's list. The <code>no</code> command removes it.
<code>exit</code>	Leaves the sub-command mode.

Table 202 content-filter Filtering Profile Commands Summary (continued)

COMMAND	DESCRIPTION
[no] content-filter profile <i>filtering_profile</i> custom proxy	Sets a Web Content Filter profile to block access to web proxy servers. The <b>no</b> command sets the profile to allow access to proxy servers.
content-filter profile <i>filtering_profile</i> custom-list trust	Enters the sub-command for configuring the Web Content Filter profile's list of trusted hosts.
[no] <i>trust_hosts</i>	Adds a trusted host to the Web Content Filter profile's list. The <b>no</b> command removes it.
exit	Leaves the sub-command mode.
[no] content-filter profile <i>filtering_profile</i> custom trust-allow-features	Sets a Web Content Filter profile to permit Java, ActiveX and Cookies from sites on the trusted list. The <b>no</b> command has the content filtering profile not permit Java, ActiveX and Cookies from sites on the trusted list
[no] content-filter profile <i>filtering_profile</i> custom trust-only	Sets a Web Content Filter profile to only allow access to web sites that are on the trusted list. The <b>no</b> command has the profile allow access to web sites that are not on the trusted list.
[no] content-filter service-timeout <i>service_timeout</i>	Sets how many seconds the Zyxel Device is to wait for a response from the external content filtering server. The <b>no</b> command clears the setting.
[no] content-filter profile <i>filtering_profile</i> commtouch-url category {category_name}	Firmware v4.50 or earlier Sets a Web Content Filter profile to check for specific legacy web site categories. The <b>no</b> command has the profile not check for the specified categories.
[no] content-filter profile <i>filtering_profile</i> category {category_name}	Firmware v4.55 or later Sets a Web Content Filter profile to check for specific web site categories. The <b>no</b> command has the profile not check for the specified categories.
content-filter profile <i>filtering_profile</i> commtouch-url match-unsafe {block   log   warn   pass}	Firmware v4.50 or earlier Sets the action for attempted access to web pages that match the Web Content Filter profile's selected legacy unsafe categories.  Block access, log access, or allow access.
content-filter profile <i>filtering_profile</i> commtouch-url match {block   log   pass}	Firmware v4.50 or earlier Sets the action for attempted access to web pages that match the Web Content Filter profile's selected legacy managed categories.  Block access, allow and log access, display a warning message before allowing access, or allow access.
content-filter profile <i>filtering_profile</i> [commtouch-url] match {block   log   pass}	Firmware v4.55 or later Sets the action for attempted access to web pages that match the profile's selected managed categories.  Block access, allow and log access, display a warning message before allowing access, or allow access.  The <i>commtouch-url</i> option has no effect, and is only included for compatibility.

Table 202 content-filter Filtering Profile Commands Summary (continued)

COMMAND	DESCRIPTION
<pre>content-filter profile filtering_profile commtouch-url offline {block   log   warn   pass}</pre>	<p>Firmware v4.50 or earlier</p> <p>Sets the action for attempted access to web pages if the legacy external web filtering database is unavailable.</p> <p>Block access, allow and log access, display a warning message before allowing access, or allow access.</p>
<pre>content-filter profile filtering_profile [commtouch-url] offline {block   log   warn   pass}</pre>	<p>Firmware v4.55 or later</p> <p>Sets the action for attempted access to web pages if the external web filtering database is unavailable.</p> <p>Block access, allow and log access, display a warning message before allowing access, or allow access.</p> <p>The <i>commtouch-url</i> option has no effect, and is only included for compatibility.</p>
<pre>content-filter profile filtering_profile commtouch-url unrate {block   log   warn   pass}</pre>	<p>Firmware v4.50 or earlier</p> <p>Sets the action for attempted access to web pages that the legacy external web filtering service has not categorized.</p> <p>Block access, allow and log access, display a warning message before allowing access, or allow access.</p>
<pre>content-filter profile filtering_profile [commtouch-url] unrate {block   log   warn   pass}</pre>	<p>Firmware v4.55 or later</p> <p>Sets the action for attempted access to web pages that the external web filtering service has not categorized.</p> <p>Block access, allow and log access, display a warning message before allowing access, or allow access.</p> <p>The <i>commtouch-url</i> option has no effect, and is only included for compatibility.</p>
<pre>content-filter profile filtering_profile commtouch-url log- all</pre>	<p>Firmware v4.50 or earlier</p> <p>The Zyxel Device creates a log message each time an IPv4 address is scanned by the Web Content Filter service.</p>
<pre>content-filter profile filtering_profile [commtouch-url] log-all</pre>	<p>Firmware v4.55 or later</p> <p>The Zyxel Device creates a log message each time an IPv4 address is scanned by the Web Content Filter service.</p> <p>The <i>commtouch-url</i> option has no effect, and is only included for compatibility.</p>
<pre>no content-filter profile filtering_profile commtouch-url match-unsafe {log}</pre>	<p>Has the Zyxel Device not log attempted access to web pages that match the profile's selected legacy unsafe categories.</p>
<pre>no content-filter profile filtering_profile commtouch-url match {log}</pre>	<p>Firmware v4.50 or earlier</p> <p>Has the Zyxel Device not log attempted access to web pages that match the profile's selected legacy managed categories.</p>
<pre>no content-filter profile filtering_profile [commtouch-url] match {log}</pre>	<p>Firmware v4.55 or later</p> <p>Has the Zyxel Device not log attempted access to web pages that match the profile's selected managed categories.</p> <p>The <i>commtouch-url</i> option has no effect, and is only included for compatibility.</p>

Table 202 content-filter Filtering Profile Commands Summary (continued)

COMMAND	DESCRIPTION
no content-filter profile <i>filtering_profile</i> commtouch-url offline {log}	Firmware v4.50 or earlier  Has the Zyxel Device not log access to web pages if the legacy external Web Content Filter database is unavailable.
no content-filter profile <i>filtering_profile</i> [commtouch-url] offline {log}	Firmware v4.55 or later  Has the Zyxel Device not log access to web pages if the external Web Content Filter database is unavailable.  The <i>commtouch-url</i> option has no effect, and is only included for compatibility.
no content-filter profile <i>filtering_profile</i> commtouch-url unrate {log}	Firmware v4.50 or earlier  Has the Zyxel Device not log access to web pages that the legacy external Web Content Filter has not categorized.
no content-filter profile <i>filtering_profile</i> [commtouch-url] unrate {log}	Firmware v4.55 or later  Has the Zyxel Device not log access to web pages that the external Web Content Filter service has not categorized.  The <i>commtouch-url</i> option has no effect, and is only included for compatibility.
[no] content-filter sslv3 action block	Has the Zyxel Device block HTTPS web pages using SSL V3 or a previous version.  The no command allows HTTPS web pages using SSL V3 or a previous version.
[no] content-filter https-domain- filter block-page activate	Has the ZyWALL/USG display a warning page instead of a blank page when an HTTPS connection is redirected.  The no command has the ZyWALL/USG display a blank page when an HTTPS connection is blocked.
content-filter https-domain-filter block-page port <port>	Changes the port number of the HTTPS Domain Filter blocking page. The default port is 54088.
content-filter https-domain-filter block-cache-ttl <1~60>	Sets how many seconds (1-60) to keep blocked HTTPS pages in the cache. The default value is 5.
content-filter https-domain-filter forward-cache-ttl <1~1440>	Sets how many minutes (1-1440) to keep forwarded HTTPS pages in the cache. The default value is 60.
[no] content-filter profile < <i>filtering_profile</i> > safesearch	Enables SafeSearch in the specified Web Content Filter profile.  SafeSearch is a feature of a search engine that can automatically filter sexually explicit videos and images from the search result without overloading the Zyxel Device. It does this by adding a parameter in the search URL: <a href="https://www.google.com.tw/?gws_rd=ssl#q=porn&amp;safe=active">https://www.google.com.tw/?gws_rd=ssl#q=porn&amp;safe=active</a> .  Supported search engines at the time of writing are:  Yahoo, Google, MSN Live Bing, Yandex
[no] content-filter safesearch <name>	Creates a Web Content Filter safesearch rule and enters sub-command mode.  The no command removes the rule.
domain match <string>	Sets a string that the domain name should (partially) match in a safesearch rule. For example, domain-match: .google.
domain not-match <string>	Sets a string that the domain name should not match in a safesearch rule.

Table 202 content-filter Filtering Profile Commands Summary (continued)

COMMAND	DESCRIPTION
<code>url match &lt;string&gt;</code>	Sets a string that the URL should (partially) match in a safesearch rule. For example, <code>url-match: search</code>
<code>url not-match &lt;string&gt;</code>	Sets a string that the URL should not match in a safesearch rule.
<code>url parameter &lt;string&gt;</code>	Sets a parameter that updates the URL when there is a safesearch rule match. Values in URL Parameters are set dynamically in a page's URL. Example <code>url-parameter: safe=</code>
<code>url value &lt;string&gt;</code>	Sets a value that updates the URL when there is a safesearch rule match. Example <code>url-value: active</code>
<code>cookie match &lt;string&gt;</code>	Sets a string that the cookie should (partially) match in a safesearch rule. A cookie is a small piece of data sent from a website and stored in the user's web browser.
<code>cookie parameter &lt;string&gt;</code>	Sets a parameter that updates the cookie when there is a safesearch rule match. Parameters store information such as the cookie's expiration, domain, and flags.
<code>cookie value &lt;string&gt;</code>	Sets a value that updates the cookie when there is a safesearch rule match. The value of a cookie can be modified by the server in response to a page request.
<code>show content-filter safesearch</code>	Displays all safesearch rules created and their sub-command contents.
<code>show content-filter profile commtouch</code>	Firmware v4.50 or earlier Displays a list of all Web Content Filter profiles.
<code>show content-filter profile</code>	Firmware v4.55 or later Displays a list of all Web Content Filter profiles.
<code>show content-filter profile [filtering_profile] commtouch</code>	Firmware v4.50 or earlier Displays the settings of the specified Web Content Filter profile, including which categories it blocks.
<code>show content-filter profile [filtering_profile]</code>	Firmware v4.55 or later Displays the settings of the specified Web Content Filter profile, including which categories it blocks.

### 43.4.3 Web Content Filtering Statistics

The following table describes the commands for collecting and displaying web content filtering statistics. You must use the `configure terminal` command to enter the configuration mode before you can use these commands.

Table 203 Commands for Content Filtering Statistics

COMMAND	DESCRIPTION
<code>[no] content-filter statistics collect</code>	Turn the collection of Web Content Filter statistics on or off.
<code>content-filter statistics flush</code>	Clears the collected Web Content Filter statistics.
<code>show content-filter statistics summary</code>	Displays the collected Web Content Filter statistics.

Table 203 Commands for Content Filtering Statistics (continued)

COMMAND	DESCRIPTION
<code>show content-filter statistics collect</code>	Displays whether the collection of Web Content Filter statistics is turned on or off.
<code>show content-filter statistics summary</code>	Displays the current Web Content Filter statistics.

### 43.4.4 Web Content Filtering Statistics Example

This example shows how to collect and display Web Content Filter statistics.

```
Router(config)# content-filter statistics collect
Router(config)# show content-filter statistics summary
total web pages inspected           : 0
  web pages warned by category service : 0
  web pages blocked by category service: 0
  web pages blocked by custom service  : 0
    restricted web features           : 0
    forbidden web sites                : 0
    url keywords                       : 0
    web pages passed                   : 0

unsafe web pages                    : 0
other web pages                      : 0
```

## 43.5 DNS Content Filter

The following section describes the commands for the DNS content filter.

### 43.5.1 DNS Content Filter Commands

The following table lists the commands that you can use for general DNS content filter configuration. Use the `configure` terminal command to enter the configuration mode to be able to use these commands. See [Table 200 on page 358](#) for details about the values you can input with these commands.

Table 204 DNS Content Filter Commands

COMMAND	DESCRIPTION
<code>dns-content-filter black-list <i>FQDN</i> {activate   deactivate}</code>	Activates or deactivates the specified Fully Qualified Domain Name (FQDN) in the DNS Content Filter black list.  If the FQDN is not already in the black list, the Zyxel Device adds it.  FQDN example: <code>www.zyxel.com.tw</code>
<code>no dns-content-filter black-list <i>FQDN</i></code>	Removes the specified Fully Qualified Domain Name (FQDN) from the DNS Content Filter black list.
<code>[no] dns-content-filter black-list activate</code>	Enables or disables the DNS Content Filter black list.  The Zyxel Device treats all FQDNs in the blacklist as prohibited, and applies DNS Content filter rules when they are queried.

Table 204 DNS Content Filter Commands (continued)

COMMAND	DESCRIPTION
<code>dns-content-filter black-list replace &lt;1..256&gt; FQDN {activate   deactivate}</code>	Replaces the Fully Qualified Domain Name (FQDN) of the specified entry with a new one in the DNS Content Filter black list.
<code>dns-content-filter redirect-ip custom IPv4</code>	Sets the redirect IP address for prohibited DNS queries to the specified IPv4 address.  This setting is used when <code>dns-content-filter profile &gt; action</code> is set to <code>redirect</code> .
<code>dns-content-filter redirect-ip default</code>	Sets the redirect IPv4 address for prohibited DNS queries to the default, which is the IP address of the DNS Content Filter server ( <code>dnsft.cloud.zyxel.com</code> ).  This setting is used when <code>dns-content-filter profile &gt; action</code> is set to <code>redirect</code> .
<code>dns-content-filter white-list FQDN {activate   deactivate}</code>	Activates or deactivates the specified Fully Qualified Domain Name (FQDN) in the DNS Content Filter white list.  If the FQDN is not already in the white list, the Zyxel Device adds it.  FQDN example: <code>www.zyxel.com.tw</code>
<code>no dns-content-filter white-list FQDN</code>	Removes the specified Fully Qualified Domain Name (FQDN) from the DNS Content Filter white list.
<code>[no] dns-content-filter white-list activate</code>	Enables or disables the DNS Content Filter white list.  The Zyxel Device treats all FQDNs in the white list as non-prohibited, and does not apply DNS Content Filter rules when they are queried.
<code>dns-content-filter white-list replace &lt;1..256&gt; FQDN {activate   deactivate}</code>	Replaces the Fully Qualified Domain Name (FQDN) of the specified entry with a new one in the DNS Content Filter white list.
<code>show dns-content-filter {white-list   black-list}</code>	Displays the current DNS Content Filter white or black list.
<code>show dns-content-filter dashboard statistics summary</code>	Displays the total number of Fully Qualified Domain Names (FQDNs) that the Zyxel Device has scanned, and the number of prohibited FQDNs detected, as displayed on the Web Configurator dashboard.
<code>show dns-content-filter profile {all   profileName}</code>	Shows the name and settings of each DNS Content Filter profiles, or the specified DNS Content Filter profile.
<code>show dns-content-filter search FQDN</code>	Runs a DNS query for the specified Fully Qualified Domain Name (FQDN) and returns the result according to the current DNS Content Filter rules.
<code>show dns-content-filter status</code>	Displays the action and log settings for the <code>dns-content-filter</code> service.
<code>dns-content-filter fake-dns-response-ttl &lt;300...86400&gt;</code>	Sets the time period in seconds for redirecting clients to a default or custom-defined IP address when the clients try to access a blocked FQDN.  If you remove an FQDN from the block list before the response time-to-live (TTL) time is up, the clients will still be redirected to a default or custom-defined IP address when they try to access the FQDN.
<code>show dns-content-filter fake-dns-response-ttl</code>	Displays how long the clients will be redirected to a default or custom-defined IP address when the clients try to access a blocked FQDN.



## 43.5.2 DNS Content Filter Profile Commands

The following table lists the commands that you can use to configure a DNS content filter profile. Use the `configure terminal` command to enter the configuration mode to be able to use these commands. See [Table 200 on page 358](#) for details about the values you can input with these commands.

Table 205 dns-content-filter Profile Commands Summary

COMMAND	DESCRIPTION
<code>dns-content-filter profile <i>profilename</i></code>	Enter subcommand mode and edit the specified DNS Content Filter configuration profile. If the profile does not currently exist, the Zyxel Device creates it.
<code>action {pass   redirect}</code>	Choose what the Zyxel Device does when it detects a prohibited DNS query packet.  <i>pass</i> : Have the Zyxel Device allow the DNS query packet and not reply a DNS reply packet with a fake IP for it.  <i>redirect</i> : Have the Zyxel Device reply with a DNS reply packet containing a default or custom-defined IP address.  The default redirect IP is the IP address of the DNS Content Filter server ( <a href="https://dnsft.cloud.zyxel.com">dnsft.cloud.zyxel.com</a> ).
<code>[no] black-list activate</code>	Enables or disables the DNS Content Filter black list for this profile.
<code>[no] category <i>category_name</i></code>	The Zyxel Device considers DNS queries that match the specified category to be prohibited.  The <i>no</i> command means the Zyxel Device ignores DNS queries that match the specified category.
<code>description <i>description</i></code>	Sets a description for the profile. You can use up to 60 printable ASCII characters.
<code>[no] description</code>	Deletes the description for this profile.
<code>[no] log</code>	The Zyxel Device generates a log message when it detects a prohibited DNS query packet.  The <i>no</i> command means the Zyxel Device does not generate a log message or alert when it detects a DNS query packet.
<code>log-alert</code>	The Zyxel Device generates a log message and an alert when it detects a prohibited DNS query packet.
<code>[no] white-list activate</code>	Enables or disables the DNS Content Filter white list for this profile.

## 43.5.3 DNS Content Filtering Statistics

The following table describes the commands for collecting and displaying DNS Content Filter statistics. You must use the `configure terminal` command to enter the configuration mode before you can use these commands.

Table 206 Commands for DNS Content Filter Statistics

COMMAND	DESCRIPTION
<code>[no] dns-content-filter statistics collect</code>	Turn the collection of DNS Content Filter statistics on or off.
<code>dns-content-filter statistics flush</code>	Clears the collected DNS Content Filter statistics.

Table 206 Commands for DNS Content Filter Statistics (continued)

COMMAND	DESCRIPTION
<code>show dns-content-filter statistics collect</code>	Displays whether the collection of DNS Content Filter statistics is turned on or off.
<code>show dns-content-filter statistics list</code>	Displays the collected DNS Content Filter statistics.
<code>show dns-content-filter statistics summary</code>	Displays the total number of Fully Qualified Domain Names (FQDNs) that the Zyxel Device has scanned, and the number of prohibited FQDNs detected.

## 43.6 Web Content Filtering Example

The following example shows how to limit the web access for a sales group using the web content filter.

- 1 First, create a sales address object. This example uses a subnet that covers IP addresses 172.21.3.1 to 172.21.3.254.
- 2 Then create a schedule for all day.
- 3 Create a filtering profile for the group.
- 4 You can use the following commands to block sales from accessing job search websites.
- 5 Enable the external web filtering service.

Note: You must register for the external web filtering service before you can use it (see [Chapter 5 on page 52](#)).

- 6 You can also customize the filtering profile. The following commands block active-X, java and proxy access.
- 7 Append a Secure Policy with content filter profile.

```
Router# configure terminal
Router(config)# address-object sales 172.2.3.0/24
Router(config)# schedule-object all_day 00:00 23:59
Router(config)# content-filter profile sales_CF_PROFILE
Router(config)# content-filter profile sales_CF_PROFILE category job-search
Router(config)# content-filter profile sales_CF_PROFILE url-server
Router(config)# content-filter profile sales_CF_PROFILE custom java
Router(config)# content-filter profile sales_CF_PROFILE custom activex
Router(config)# content-filter profile sales_CF_PROFILE custom proxy
Router(config)# content-filter profile sales_CF_PROFILE custom
Router(config)# secure-policy insert 1
Router(config)# name UTM
Router(config)# from LAN1
Router(config)# schedule all_day
Router(config)# sourceip sales
Router(config)# no app-profile
Router(config)# cf-profile sales_CF_PROFILE log by-profile activate
Router(config)# exit
```

Use this command to display the settings of the profile.

```
Router(config)# show content-filter profile sales_CF_PROFILE
safesearch active : no
service active : yes
url match unsafe: action: warn, log: no
url match other : action: block, log: no
url unrate      : action: warn, log: no
service offline : action: warn, log: no
all log active  : no

category settings:
Art/Culture/Heritage      : no, Alcohol : no
Anonymizers               : yes, Adult Topics : no
Anonymizing Utilities     : no, Business : yes
Chat                      : no, Computing/Internet : no
Public Information        : no, Potential Criminal Activities : no
Drugs                     : no, Education/Reference : no
Entertainment             : no, Extreme : no
Finance/Banking           : no, Gambling : no
Games                     : no, Government/Military : no
Potential Hacking/Computer Crime: no, Health : no
Humor/Comics              : no, Discrimination : no
Instant Messaging         : no, Stock Trading : no
Internet Radio/TV         : no, Job Search : yes
Information Security      : no, Dating/Social Networking : no
Mobile Phone              : no, Media Downloads : no
Malicious Sites           : yes, Usenet News : no
Nudity                    : no, Non-Profit/Advocacy/NGO : no
...
```

## 43.7 Content Filter Category Definitions

Table 207 Legacy Category Descriptions (Firmware v4.50 or earlier)

CATEGORY	DESCRIPTION
Advertisements & Pop-Ups	Sites that provide advertising graphics or other ad content files such as banners and pop-ups.
Alcohol & Tobacco	Sites that promote or sell alcohol- or tobacco-related products or services.
Arts	Sites with artistic content or relating to artistic institutions such as theaters, museums, galleries, dance companies, photography, and digital graphic resources.
Business	Sites that provide business related information such as corporate Web sites. Information, services, or products that help businesses of all sizes to do their day-to-day commercial activities.
Transportation	Sites that provide information about motor vehicles such as cars, motorcycles, boats, trucks, RVs and the like. Includes manufacturer sites, dealerships, review sites, pricing,, online purchase sites, enthusiasts clubs, etc.
Chat	Sites that enable web-based exchange of real time messages through chat services or chat rooms.
Forums & Newsgroups	Sites for sharing information in the form of newsgroups, forums, bulletin boards.
Computers & Technology	Sites that contain information about computers, software, hardware, IT, peripheral and computer services, such as product reviews, discussions, and IT news.
Criminal Activity	Sites that offer advice on how to commit illegal or criminal activities, or to avoid detection. These can include how to commit murder, build bombs, pick locks, etc. Also includes sites with information about illegal manipulation of electronic devices, hacking, fraud and illegal distribution of software.
Dating & Personals	Sites that promote networking for interpersonal relationships such as dating and marriage. Includes sites for match-making, online dating, spousal introduction.
Download Sites	Sites that contain downloadable software, whether shareware, freeware, or for a charge. Includes peer-to-peer sites.
Education	Sites sponsored by educational institutions and schools of all types including distance education. Includes general educational and reference materials such as dictionaries, encyclopedias, online courses, teaching aids and discussion guides.
Entertainment	Sites related to television, movies, music and video (including video on demand), such as program guides, celebrity sites, and entertainment news.
Finance	Sites related to banking, finance, payment or investment, including banks, brokerages, online stock trading, stock quotes, fund management, insurance companies, credit unions, credit card companies, and so on.
Gambling	Sites that offer or are related to online gambling, lottery, casinos and betting agencies involving chance.
Games	Sites relating to computer or other games, information about game producers, or how to obtain cheat codes. Game-related publication sites.
Government	Sites run by governmental organizations, departments, or agencies, including police departments, fire departments, customs bureaus, emergency services, civil defense, counter-terrorism organizations, military and hospitals.
Hate & Intolerance	Sites that promote a supremacist political agenda, encouraging oppression of people or groups of people based on their race, religion, gender, age, disability, sexual orientation or nationality.

Table 207 Legacy Category Descriptions (Firmware v4.50 or earlier)

Health & Medicine	Sites containing information pertaining to health, healthcare services, fitness and well-being, including information about medical equipment, hospitals, drugstores, nursing, medicine, procedures, prescription medications, etc.
Illegal Drugs	Sites with information on the purchase, manufacture, and use of illegal or recreational drugs and their paraphernalia, and misuse of prescription drugs and other compounds.
Job Search	Sites containing job listings, career information, assistance with job searches (such as resume writing, interviewing tips, etc.), employment agencies or head hunters.
Streaming Media & Downloads	Sites that deliver streaming content, such as Internet radio, Internet TV or MP3 and live or archived media download sites. Includes fan sites, or official sites run by musicians, bands, or record labels.
News	Sites covering news and current events such as newspapers, newswire services, personalized news services, broadcasting sites, and magazines.
Non-profits & NGOs	Sites devoted to clubs, communities, unions, and non-profit organizations. Many of these groups exist for educational or charitable purposes.
Nudity	Sites that contain full or partial nudity that are not necessarily overtly sexual in intent. Includes sites that advertise or sell lingerie, intimate apparel, or swim wear.
Personal Sites	Sites about or hosted by personal individuals, including those hosted on commercial sites.
Politics	Sites that promote political parties or political advocacy, or provide information about political parties, interest groups, elections, legislation or lobbying. Also includes sites that offer legal information and advice.
Pornography/Sexually Explicit	Sites that contain explicit sexual content. Includes adult products such as sex toys, CD-ROMs, and videos, adult services such as videoconferencing, escort services, and strip clubs, erotic stories and textual descriptions of sexual acts.
Real Estate	Sites relating to commercial or residential real estate services, including renting, purchasing, selling or financing homes, offices, etc.
Religion	Sites that deal with faith, human spirituality or religious beliefs, including sites of churches, synagogues, mosques and other houses of worship.
Restaurants & Dining	Sites that list, review, promote or advertise food, dining or catering services. Includes sites for recipes, cooking instruction and tips, food products, and wine advisors.
Search Engines & Portals	Sites enabling the searching of the Web, newsgroups, images, directories, and other online content. Includes portal and directory sites such as white/yellow pages.
Shopping	Sites for online shopping, catalogs, online ordering, auctions, classified ads. Excludes shopping for products and services exclusively covered by another category such as health & medicine.
Social Networking	Sites that enable social networking for online communities of various topics, for friendship, dating, or professional reasons.
Sports	Sites relating to sports teams, fan clubs, scores and sports news. Relates to all sports, whether professional or recreational.
Translators	Sites that translate Web pages or phrases from one language to another. These sites may be used to attempt to bypass a filtering system.
Travel	Sites that provide travel and tourism information or online booking of travel services such as airlines, accommodations, car rentals. Includes regional or city information sites.
Violence	Sites that contain images or text depicting or advocating physical assault against humans, animals, or institutions. Sites of a particularly gruesome nature such as shocking depictions of blood or wounds, or cruel animal treatment.
Weapons	Sites that depict, sell, review or describe guns and weapons, including for sport.

Table 207 Legacy Category Descriptions (Firmware v4.50 or earlier)

Web-based Email	Sites that enable users to send and receive email through a web-accessible email account.
General	Sites that do not clearly fall into other categories, for example, blank Web pages.
Leisure & Recreation	Sites relating to recreational activities and hobbies including zoos, public recreation centers, pools, amusement parks, and hobbies such as gardening, literature, arts & crafts, home improvement, home decor, family, etc.
Cults	Sites relating to non-traditional religious practice typically known as "cults," that is, considered to be false, unorthodox, extremist, or coercive, with members often living under the direction of a charismatic leader.
Fashion & Beauty	Sites concerning fashion, jewelry, glamour, beauty, modeling, cosmetics or related products or services. Includes product reviews, comparisons, and general consumer information.
Greeting cards	Sites that allow people to send and receive greeting cards and postcards.
Hacking	Sites that promote or give advice about how to gain unauthorized access to proprietary computer systems, for the purpose of stealing information, perpetrating fraud, creating viruses, or committing other illegal activity related to theft of digital information.
Illegal Software	Sites that illegally distribute software or copyrighted materials such as movies or music, software cracks, illicit serial numbers, illegal license key generators.
Image Sharing	Sites that host digital photographs and images, online photo albums and digital photo exchanges.
Information Security	Sites that provide legitimate information about data protection, including newly discovered vulnerabilities and how to block them.
Instant Messaging	Sites that enable logging in to instant messaging services such as ICQ, AOL Instant Messenger, IRC, MSN, Jabber, Yahoo Messenger, and the like.
Peer-to-Peer	Sites that enable direct exchange of files between users without dependence on a central server.
Private IP Addresses	Sites that are private IP addresses as defined in RFC 1918, that is, hosts that do not require access to hosts in other enterprises (or require just limited access) and whose IP address may be ambiguous between enterprises but are well defined within a certain enterprise.
School Cheating	Sites that promote unethical practices such as cheating or plagiarism by providing test answers, written essays, research papers, or term papers.
Sex Education	Sites relating to sex education, including subjects such as respect for partner, abortion, gay and lesbian lifestyle, contraceptives, sexually transmitted diseases, and pregnancy.
Tasteless	Sites with offensive or tasteless content such as bathroom humor or profanity.
Child Abuse Images	Sites that portray or discuss children in sexual or other abusive acts.
Unknown	URLs unknown to the content filtering database.

Table 208 New Managed Category Descriptions (Firmware v4.55 or later)

CATEGORY	DESCRIPTION
Adult Topics	Web pages that contain content or themes that are generally considered unsuitable for children.
Alcohol	Web pages that mainly sell, promote, or advocate the use of alcohol, such as beer, wine, and liquor.  This category also includes cocktail recipes and home-brewing instructions.

Table 208 New Managed Category Descriptions (Firmware v4.55 or later) (continued)

Anonymizing Utilities	<p>Web pages that result in anonymous web browsing without the explicit intent to provide such a service.</p> <p>This category includes URL translators, web-page caching, and other utilities that might function as anonymizers, but without the express purpose of bypassing filtering software.</p> <p>This category does not include text translation.</p>
Art Culture Heritage	<p>Web pages that contain virtual art galleries, artist sites (including sculpture and photography), museums, ethnic customs, and country customs.</p> <p>This category does not include online photograph albums.</p>
Auctions Classifieds	<p>Web pages that provide online bidding and selling of items or services.</p> <p>This category includes web pages that focus on bidding and sales.</p> <p>This category does not include classified advertisements such as real estate postings, personal ads, or companies marketing their auctions.</p>
Blogs Wiki	<p>Web pages containing dynamic content, which often changes because users can post or edit content at any time.</p> <p>This category covers the risks with dynamic content that might range from harmless to offensive.</p>
Business	<p>Web pages that provide business-related information, such as corporate overviews or business planning and strategies.</p> <p>This category also includes information, services, or products that help other businesses plan, manage, and market their enterprises, and multi-level marketing.</p> <p>This category does not include personal pages and web-hosting web pages.</p>
Chat	<p>Web pages that provide web-based, real-time social messaging in public and private chat rooms. This category includes IRC.</p> <p>This category does not include instant messaging.</p>
Computing Internet	<p>Web pages containing reviews, information, buyer's guides of computers, computer parts and accessories, computer software and Internet companies, industry news and magazines, and pay-to-surf sites.</p>
Consumer Protection	<p>Websites that try to rob or cheat consumers.</p> <p>Some examples of their activities include selling counterfeit products, selling products that were originally provided for free, or improperly using the brand of another company. This category also includes sites where many consumers reported being cheated or not receiving services.</p> <p>This category does not include phishing, which tries to perpetrate fraud or theft by stealing account information.</p>
Content Server	<p>URLs for servers that host images, media files, or JavaScript for one or more sites and are intended to speed up content retrieval for existing web servers, such as Apache.</p> <p>This category includes domain-level and sub-domain-level URLs that function as content servers.</p> <p>This category does not include:</p> <ul style="list-style-type: none"> <li>• Web pages for businesses that provide the content servers</li> <li>• Web pages that allow users to browse photographs. See the Media Sharing category.</li> <li>• URLs for servers that serve only advertisements. See the Web Ads category.</li> </ul>

Table 208 New Managed Category Descriptions (Firmware v4.55 or later) (continued)

Controversial Opinions	<p>Web pages that contain opinions that are likely to offend political or social sensibilities and incite controversy. Much of this content is at the extremes of public opinion.</p> <p>This category does not include opinion or language clearly intended to promote hate or discrimination.</p>
Cult Occult	<p>Sites relating to non-traditional religious practices considered to be false, unorthodox, extremist, or coercive.</p>
Dating Personals	<p>Web pages that provide networking for online dating, matchmaking, escort services, or introductions to potential spouses.</p> <p>This category does not include sites that provide social networking that might include dating, but are not specific to dating.</p>
Dating Social Networking	<p>Web pages that focus on social interaction such as online dating, friendship, school reunions, pen-pals, escort services, or introductions to potential spouses.</p> <p>This category does not include wedding-related content, dating tips, or related marketing.</p>
Digital Postcards	<p>Web pages that allow people to send and receive digital postcards and greeting cards via the Internet.</p>
Discrimination	<p>Web pages, which provide information that explicitly encourages the oppression or discrimination of a specific group of individuals.</p> <p>This category does not include jokes and humor, unless the focus of the entire site is considered discriminatory.</p>
Drugs	<p>Websites that provide information on the purchase, manufacture, and use of illegal or recreational drugs.</p> <p>This category does not include sites with exclusive health or political themes.</p>
Education Reference	<p>Web pages devoted to academic-related content such as academic subjects (mathematics, history), school or university web pages, and education administration pages (school boards, teacher curriculum).</p>
Entertainment	<p>Web pages that provide information about cinema, theater, music, television, infotainment, entertainment industry gossip-news, and sites about celebrities such as actors and musicians.</p> <p>This category also includes sites where the content is devoted to providing entertainment on the web, such as horoscopes or fan clubs.</p>
Extreme	<p>Web pages that provide content considered gory, perverse, or horrific.</p>
Fashion Beauty	<p>Web pages that market clothing, cosmetics, jewelry, and other fashion-oriented products, accessories, or services.</p> <p>This category also includes product reviews, comparisons, and general consumer information, and services such as hair salons, tanning salons, tattoo studios, and body-piercing studios.</p> <p>This category does not include fashion-related content such as modeling or celebrity fashion unless the site focuses on marketing the product line.</p>
Finance Banking	<p>Web pages that provide financial information or access to online financial accounts.</p> <p>This category includes stock information (but not stock trading), home finance, and government-related financial information.</p>
For Kids	<p>Web pages that are family-safe, specifically for children of approximate ages ten and under.</p> <p>This category can also be used as an exception to allow web pages that do not pose a risk to children, or to access sites that have a primary educational or recreational focus for children, but are in other categories such as Games, Humor/Comics, Recreation/Hobbies, or Entertainment.</p>



Table 208 New Managed Category Descriptions (Firmware v4.55 or later) (continued)

Forum Bulletin Boards	<p>Web pages that provide access (<a href="http://">http://</a>) to Usenet newsgroups or hold discussions and post user-generated content, such as real-time message posting for an interest group. This category also includes archives of files uploaded to newsgroups.</p> <p>This category does not include message forums with a business or technical support focus.</p>
Gambling	<p>Web pages that allow users to wager or place bets online, or provide gambling software that allows online betting, such as casino games, betting pools, sports betting, and lotteries.</p> <p>This category does not include web pages related to gambling that do not allow betting online.</p>
Gambling Related	<p>Web pages that offer information about gambling, without providing the means to gamble.</p> <p>This category includes casino-related web pages that do not offer online gambling, gambling links, tips, sports picks, lottery results, and horse, car, or boat racing.</p>
Game Cartoon Violence	<p>Web pages that provide fantasy or fictitious representations of violence within the context of games, comics, cartoons, or graphic novels.</p> <p>This category includes images and textual descriptions of physical assaults or hand-to-hand combat, and grave injury and destruction caused by weapons or explosives.</p>
Games	<p>Web pages that offer online games and related information such as cheats, codes, demos, emulators, online contests or role-playing games, gaming clans, game manufacturer sites, fantasy or virtual sports leagues, and other gaming sites without chances of profit.</p> <p>This category includes gaming consoles.</p>
General News	<p>Web pages that provide online news media, such as international or regional news broadcasting and publication.</p> <p>This category includes portal sites that provide news content.</p>
Government Military	<p>Web pages that contain content maintained by governmental or military organizations, such as government branches or agencies, police departments, fire departments, civil defense, counter-terrorism organizations, or supranational organizations, such as the United Nations or the European Union.</p> <p>This category includes military and veterans' medical facilities.</p>
Gruesome Content	<p>Web pages with content that can be considered tasteless, gross, shocking, or gruesome.</p> <p>This category does not include web pages with content pertaining to physical assault.</p>
Health	<p>Web pages that cover all health-related information and health care services.</p> <p>This category does not include cosmetic surgery, marketing/selling pharmaceuticals, or animal-related medical services.</p>
Historical Revisionism	<p>Web pages that denounce, or offer different interpretations of, significant historical facts, such as holocaust denial.</p> <p>This category does not include all re-examination of historical facts, only historical events that are highly sensitive.</p>
History	<p>Web pages that provide content about historical facts.</p> <p>This category includes content suitable for higher education, but the Education category includes content for primary education. For example, a site with Holocaust photographs might be offensive, but have academic value.</p>

Table 208 New Managed Category Descriptions (Firmware v4.55 or later) (continued)

Humor Comics	<p>Web pages that provide comical or funny content.</p> <p>This category includes sites with jokes, sketches, comics, and satire pages. This category might also include graphic novel content, which is often associated with comics.</p>
Illegal UK	<p>Web pages that contain child sexual abuse content hosted anywhere in the world, and criminally obscene and incitement to racial hatred content hosted in the UK.</p>
Incidental Nudity	<p>Web pages that contain non-pornographic images of the bare human body like those in classic sculpture and paintings, or medical images.</p> <p>This category enables you to allow or block sites in order to address cultural or geographic differences in opinion about nudity. For example, you can use this category to block access to nudity, but allow access when nudity is not the primary focus of a site, such as news sites or major portals.</p>
Information Security	<p>Web pages that legitimately provide information about data protection. This category includes detailed information for safeguarding business or personal data, intellectual property, privacy, and infrastructure on the Internet, private networks, or in other bandwidth services such as telecommunications.</p> <p>This category does not include:</p> <ul style="list-style-type: none"> <li>• Legitimate information security companies and security software providers, such as virus protection companies.</li> <li>• Sites that intend to exploit security or teach how to bypass security.</li> </ul>
Information Security New	<p>Web pages that legitimately provide information about data protection. This category includes detailed information for safeguarding business or personal data, intellectual property, privacy, and infrastructure on the Internet, private networks, or in other bandwidth services such as telecommunications.</p> <p>This category does not include:</p> <ul style="list-style-type: none"> <li>• Legitimate information security companies and security software providers, such as virus protection companies.</li> <li>• Sites that intend to exploit security or teach how to bypass security.</li> </ul>
Instant Messaging	<p>Web pages that provide software for real-time communication over a network exclusively for users who joined a member's contact list or an instant-messaging session.</p> <p>Most instant-messaging software includes features such as file transfer, PC-to-PC phone calls, and can track when other people log on and off.</p>
Interactive Web Applications	<p>Web pages that provide access to live or interactive web applications, such as browser-based office suites and groupware. This category includes sites with business, academic, or individual focus.</p> <p>This category does not include sites providing access to interactive web applications that do not take critical user data or offer security risks, such as Google Maps.</p>
Internet Radio TV	<p>Web pages that provide software or access to continuous audio or video broadcasting, such as Internet radio, TV programming, or podcasting.</p> <p>Quick downloads and shorter streams that consume less bandwidth are in the Streaming Media or Media Downloads categories.</p>
Internet Services	<p>Web pages that provide services for publication and maintenance of Internet sites such as web design, domain registration, Internet Service Providers, and broadband and telecommunications companies that provide web services.</p> <p>This category includes web utilities such as statistics and access logs, and web graphics like clip art.</p>

Table 208 New Managed Category Descriptions (Firmware v4.55 or later) (continued)

Job Search	<p>Web pages related to a job search including sites concerned with resume writing, interviewing, changing careers, classified advertising, and large job databases. This category also includes corporate web pages that list job openings, salary comparison sites, temporary employment, and company job-posting sites.</p> <p>This category does not include make-money-at-home sites.</p>
Major Global Religions	<p>Web pages with content about religious topics and information related to major religions. This category includes sites that cover religious content such as discussion, beliefs, non-controversial commentary, articles, and information for local congregations such as a church or synagogue homepage.</p> <p>The religions in this category are Baha'i, Buddhism, Chinese Traditional, Christianity, Hinduism, Islam, Jainism, Judaism, Shinto, Sikhism, Tenrikyo, Zoroastrianism.</p>
Marketing Merchandising	<p>Web pages that promote individual or business products or services on the web, but do not sell their products or services online.</p> <p>This category includes websites that are generally a company overview, describing services or products that cannot be purchased directly from these sites. Examples include automobile manufacturer sites, wedding photography services, or graphic design services.</p> <p>This category does not include:</p> <ul style="list-style-type: none"> <li>• Other categories that imply marketing such as Alcohol, Auctions/Classifieds, Drugs, Finance/Banking, Mobile Phone, Online Shopping, Real Estate, School Cheating Information, Software/Hardware, Stock Trading, Tobacco, Travel, and Weapons.</li> <li>• Sites that market their services only to other businesses. See the Business category.</li> <li>• Sites that rob or cheat consumers. See the Consumer Protection category.</li> </ul>
Media Downloads	<p>Web pages that provide audio or video files for download such as MP3, WAV, AVI, and MPEG formats. The files are saved to, and played from, the user's computer.</p> <p>This category does not include audio or video files that are played directly through a browser window. See the Streaming Media category.</p>
Media Sharing	<p>Web pages that allow users to upload, search for, and share media files and photographs, such as online photograph albums.</p>
Messaging	<p>Examples include text messaging to mobile phones, PDAs, fax machines, and internal website user-to-user messaging or site-to-site messaging.</p> <p>This category does not include real-time chat or instant messaging, or message posts that can be viewed by anyone but the intended recipient.</p>
Mobile Phone	<p>Web pages that sell media, software, or utilities for mobile phones that can be downloaded and delivered to mobile phones.</p> <p>Examples include ringtones, logos/skins, games, screen-savers, text-based tunes, and software for SMS, MMS, WAP, and other mobile phone protocols.</p>
Moderated	<p>Bulletin boards, chat rooms, search engines, or web mail sites that are monitored by an individual or group who has the authority to block messages or content considered inappropriate.</p> <p>This category does not include sites with posted rules against offensive content. See the Forum/Bulletin Boards category.</p>

Table 208 New Managed Category Descriptions (Firmware v4.55 or later) (continued)

Motor Vehicles	<p>Websites for manufacturers and dealerships of consumer transportation vehicles, such as cars, vans, trucks, SUVs, motorcycles, and scooters. This category also includes sites that provide product marketing, reviews, comparisons, pricing information, auto fairs, auto expos, and general consumer information about motor vehicles.</p> <p>This category does not include automotive accessories, mechanics, auto-body shops, and recreational hobby pages. This category does not include sites that provide business-to-business-only content regarding motor vehicles.</p>
Non Profit Advocacy NGO	<p>Web pages from charitable or educational groups that fulfill a stated mission, benefiting the larger community, such as clubs, lobbies, communities, non-profit organizations, labor unions, and advocacy groups.</p> <p>Examples are Masons, Elks, Boy and Girl Scouts, or Big Brothers.</p>
Nudity	<p>Web pages that have non-pornographic images of the bare human body. This category includes classic sculpture and paintings, artistic nude photographs, some naturism pictures, and detailed medical illustrations.</p> <p>This category does not include high-profile sites where nudity is not a concern for visitors. See the Incidental Nudity category.</p>
Online Shopping	<p>Web pages that sell products or services online.</p> <p>Web pages selling a broad range of products might pose a risk to users by offering access to items that are normally in other categories such as Pornography, Weapons, Nudity, or Violence. Web pages selling such content exclusively are in their respective categories.</p>
P2P File Sharing	<p>Web pages that allow the exchange of files between computers and users for business or personal use, such as downloadable music.</p> <p>P2P clients allow users to search for and exchange files from a peer-user network. They often include spyware or real-time chat capabilities. This category includes BitTorrent web pages.</p>
Parked Domain	<p>Web pages that once served content, but their domains have been sold or abandoned and are no longer registered.</p> <p>Parked domains do not host their own content, but usually redirect users to a generic page that states the domain name is for sale, or redirect users to a generic search engine and portal page, some of which provide valid search engine results.</p>
Personal Network Storage	<p>Web pages that allow users to upload folders and files to an online network server in order to backup, share, edit, or retrieve files or folders from any web browser.</p>
Personal Pages	<p>Personal home pages that share a common domain such as those hosted by ISPs, university/education servers, or free web page hosts.</p> <p>This category also includes unique domains that contain personal information, such as a personal home page. This category does not include home pages of public figures.</p>
Pharmacy	<p>Web pages that provide reviews, descriptions, and market or sell prescription-based drugs, over-the-counter drugs, birth control, or dietary supplements.</p>
Politics Opinion	<p>Web pages covering political parties, individuals in political life, and opinion on various topics.</p> <p>This category might also cover laws and political opinion about drugs. This category includes URLs for political parties, political campaigning, and opinions on various topics, including political debates.</p>
Pornography	<p>Web pages, which provide materials intended to be sexually arousing or erotic.</p> <p>This category includes fetish pages, animation, cartoons, stories, and illegal pornography.</p>

Table 208 New Managed Category Descriptions (Firmware v4.55 or later) (continued)

Portal Sites	<p>Web pages that serve as major gateways or directories to content on the web.</p> <p>Many portal sites also provide a variety of internal site features or services such as search engines, email, news, and entertainment. Mailing list sites with a variety of content are in this category.</p> <p>This category does not include sites with topic-specific content.</p>
Potential Criminal Activities	<p>Web pages, which provide instructions to commit illegal or criminal activities.</p> <p>Instructions include committing murder or suicide, sabotage, bomb-making, lock-picking, service theft, evading law enforcement, or spoofing drug tests. This category might also include information on how to distribute illegal content, perpetrate fraud, or consumer scams.</p> <p>This category does not include computer-related fraud.</p>
Potential Hacking Computer Crime	<p>Web pages, which provide instructions, or otherwise enable, fraud, crime, or malicious activity that is computer-oriented.</p> <p>This category includes web pages related to computer crime include malicious hacking information or tools that help individuals gain unauthorized access to computers and networks (root kits, kiddy scripts). This category also includes other areas of electronic fraud such as dialer scams and illegal manipulation of electronic devices.</p> <p>This category does not include illegal software.</p>
Potential Illegal Software	<p>Web pages, which the filter believes offer information to potentially 'pirated' or illegally distribute software or electronic media, such as copyrighted music or film, distribution of illegal license key generators, software cracks, and serial numbers.</p> <p>This category does not include peer-to-peer web pages.</p>
Private IP Addresses	<p>Sites that are private IP addresses as defined in RFC 1918, that is, hosts that do not require access to hosts in other enterprises (or require just limited access) and whose IP address may be ambiguous between enterprises but are well defined within a certain enterprise.</p>
Profanity	<p>Web pages that contain crude, vulgar, or obscene language or gestures.</p>
Professional Networking	<p>Web pages that provide social networking exclusively for professional or business purposes.</p> <p>This category includes sites that provide personal or group profiles, and enable their members to interact through real-time communication, message posting, public bulletins, and media sharing. This category also contains alumni sites that have a networking function.</p> <p>This category does not include social networking sites where the focus might vary, but include friendship, dating, or professional focuses.</p>
Provocative Attire	<p>Web pages with pictures that include alluring or revealing attire, lingerie and swimsuits, or supermodel or celebrity photograph collections, but do not involve nudity.</p> <p>This category does not include sites with swimwear or similar attire that is not intended to be provocative. For example, Olympic swimming sites are not in this category.</p>
Public Information	<p>Web pages that provide general reference information such as public service providers, regional information, transportation schedules, maps, or weather reports.</p>
PUPs	<p>Web pages that contain Potentially Unwanted Programs (PUPs).</p> <p>PUPs are often made for a beneficial purpose but they alter the security of a computer or the computer user's privacy. Computer users who are concerned about security or privacy might want to be informed about this software, and in some cases, they might want to remove this software from their computers.</p>

Table 208 New Managed Category Descriptions (Firmware v4.55 or later) (continued)

Real Estate	<p>Web pages that provide commercial or residential real estate services and information.</p> <p>Service and information includes sales and rental of living space or retail space and guides for apartments, housing, and property, and information on appraisal and brokerage. This category includes sites that allow you to browse model homes.</p> <p>This category does not include content related to personal finance, such as credit applications.</p>
Recreation Hobbies	<p>Web pages for recreational organizations and facilities that include content devoted to recreational activities and hobbies.</p> <p>This category includes information about public swimming pools, zoos, fairs, festivals, amusement parks, recreation guides, hiking, fishing, bird watching, or stamp collecting.</p> <p>This category does not include activities that need no active participation, such as watching a movie or reading celebrity gossip.</p>
Religion Ideology	<p>Web pages with content related to religious topics and beliefs in human spirituality that are not within the major religions.</p> <p>This category includes religious discussion, beliefs, articles, and information for local congregations or groups such as a church homepage, unless the site is already in the Major Global Religions category. This category also includes comparative religion, or sites that include religions and ideologies.</p> <p>This category does not include astrology and horoscope sites</p>
Remote Access	<p>Web pages that provide remote access to a program, online service, or an entire computer system.</p> <p>Although remote access is often used legitimately to run a computer from a remote location, it creates a security risk, such as backdoor access. Backdoor access, written by the original programmer, allows the system to be controlled by another party without the user's knowledge.</p>
Reserved	This category is reserved for future use.
Residential IP Addresses	<p>IP addresses (and any domains associated with them) that access the Internet by DSL modems or cable modems.</p> <p>Because this content is not generally intended for Internet access via HTTP, access to the Internet through these IP addresses can indicate suspicious behavior. This behavior might be related to malware located on the home computer or homegrown gateways set up to allow anonymous Internet access.</p>
Resource Sharing	<p>Web pages that harness idle or unused computer resources to focus on a common task.</p> <p>The task can be on a company or an international basis. Well known examples are the SETI program and the Human Genome Project, which use the idle time of thousands of volunteered computers to analyze data.</p>
Restaurants	<p>Web pages that provide information about restaurants, bars, catering, take-out and delivery, including online ordering.</p> <p>This category includes sites that provide information about location, hours, prices, menus and related dietary information. This category also includes restaurant guides and reviews, and cafes and coffee shops.</p> <p>This category does not include groceries, wholesale food, non-profit and charitable food organizations, or bars that do not focus on serving food.</p>
School Cheating Information	<p>Web pages that promote plagiarism or cheating by providing free or fee-based term papers, written essays, or exam answers.</p> <p>This category does not include sites that offer student help, discuss literature, films, or books, or other content that is often the subject of research papers.</p>

Table 208 New Managed Category Descriptions (Firmware v4.55 or later) (continued)

Search Engines	<p>Web pages that provide search results that enable users to find information on the Internet based on key words.</p> <p>This category does not include site-specific search engines.</p>
Sexual Materials	<p>Web pages that describe or depict sexual acts, but are not intended to be arousing or erotic.</p> <p>Examples of sexual materials include sex education, sexual innuendo, humor, or sex related merchandise.</p> <p>This category does not include web pages with content intended to arouse.</p>
Shareware Freeware	<p>Web pages that are repositories of downloadable copies of shareware and freeware.</p> <p>This category does not include subscription-based software.</p>
Social Networking	<p>Web pages that enable social networking for a variety of purposes, such as friendship, dating, professional, or topics of interest.</p> <p>These sites provide personal or group profiles and enable interaction among their members through real-time communication, message posting, public bulletins, and media sharing.</p> <p>This category does not include sites that are exclusive to dating, matchmaking, or a specific professional networking focus.</p>
Software Hardware	<p>Web pages related to computing software and hardware, including vendors, product marketing and reviews, deployment and maintenance of software and hardware, and software updates and add-ons such as scripts, plug-ins, or drivers. Hardware includes computer parts, accessories, and electronic equipment used with computers and networks.</p> <p>This category includes the marketing of software and hardware, and magazines focused on software or hardware product reviews or industry trends.</p>
Sports	<p>Web pages related to professional or organized recreational sports.</p> <p>This category includes sporting news, events, and information such as playing tips, strategies, game scores, or player trades.</p> <p>This category does not include fantasy leagues, sports centers, athletic clubs, fitness or martial arts clubs, and non-league billiards, darts, or other such activities.</p>
Stock Trading	<p>Web pages that offer purchasing, selling, or trading of shares online.</p> <p>This category also includes ticker-tape information that enables viewing of real-time stock prices and financial spread betting in the stock market. Other betting is in the Gambling category.</p> <p>This category does not include sites that offer information about stocks, but do not offer purchasing, selling, or trading of shares.</p>
Streaming Media	<p>Web pages that provide streaming media, or contain software plug-ins for displaying audio and visual data before the entire file has been transmitted.</p> <p>This category does not include audio or video files that are downloaded to a user's computer before being played.</p>
Technical Business Forums	<p>Web pages with a technical or business focus that provide online message posting or real-time chatting, such as technical support or interactive business communication.</p> <p>Although users can post any type of content, these forums tend to present less risk of containing offensive content.</p> <p>Sites that offer a variety of forums with themes, including technical and business content, are only in the categories of Forum/Bulletin Boards or Chat.</p>

Table 208 New Managed Category Descriptions (Firmware v4.55 or later) (continued)

Technical Information	<p>Web pages that provide computing information with an educational focus in areas such as Information Technology, computer programming, and certification.</p> <p>Examples include Linux user groups, UNIX commands, software tutorials, or dictionaries of technical terms. Most sites in this category might be subdirectories of larger domains. For example, a software site with a tutorial page is in this category only at the tutorial page URL.</p> <p>This category does not include content about information security.</p>
Text Spoken Only	<p>Content that is text or audio only, and does not contain pictures.</p> <p>This category can be used as an exception to allow explicit text and recorded material to be accessed when you want pictures blocked using the Pornography, Violence, or Sexual Materials categories. Libraries or universities can use this category to prevent the display of offensive graphics in their public facilities.</p>
Text Translators	<p>Web pages that allow users to type phrases or a block of text to translate it from one language into another.</p> <p>This category also includes language identifier web pages. URL translation is in the Anonymizing Utilities category.</p>
Tobacco	<p>Web pages that sell, promote, or advocate the use of tobacco products, tobacco paraphernalia, including cigarettes, cigars, pipes, snuff and chewing tobacco.</p>
Travel	<p>Web pages that promote personal or business travel, such as hotels, resorts, airlines, ground transportation, car rentals, travel agencies, and general tourist and travel information.</p> <p>This category also includes sites for buying tickets or accommodation.</p> <p>This category does not include personal vacation photographs.</p>
Usenet News	<p>Web pages that provide access (<a href="http://">http://</a>) to Usenet newsgroups and archives of files uploaded to newsgroups.</p> <p>This category also includes online groups that offer similar community-oriented content posting.</p>
Violence	<p>Web pages that contain real or lifelike images or text that portray, describe, or advocate physical assaults against people, animals, or institutions, such as depictions of war, suicide, mutilation, or dismemberment.</p>
Visual Search Engine	<p>Web pages that provide image-specific search results such as thumbnail pictures.</p> <p>This category does not include sites that offer site-specific visual search engines.</p>
Weapons	<p>Web pages that provide information about buying, making, modifying, or using weapons, such as guns, knives, swords, paintball guns, and ammunition, explosives, and weapon accessories.</p> <p>This category also includes sites that contain content for: weapons for personal or military use, homemade weapons, non-lethal weapons such as mace, pepper spray, or Taser guns, weapons facilities, such as shooting ranges, and government or military oriented weapons.</p> <p>This category does not include political action groups, such as the NRA.</p>



Table 208 New Managed Category Descriptions (Firmware v4.55 or later) (continued)

Web Ads	<p>Web pages that provide advertisement-hosting or programs that create advertisements.</p> <p>Examples include links, source code or applets for banners, popups, and other kinds of static or dynamically generated advertisements that appear on web pages. This category is intended to block advertisements on web pages, not the companies that provide the advertisements or advertising services.</p> <p>This category does not include aggressive advertising adware. See the Spyware/Adware category.</p>
Web Mail	Web pages that enable users to send or receive email through the Internet.
Web Meetings	<p>Web pages that host live meetings, video conferences, and interactive presentations mainly for businesses.</p> <p>Web meetings generally include streaming audio and video, and allow data transfer or office-oriented application sharing, such as online presentations.</p>
Web Phone	<p>Web pages that enable users to make telephone calls via the Internet or obtain information or software for this purpose.</p> <p>Web Phone service is also called Internet Telephony, or VoIP. Web phone service includes PC-to-PC, PC-to-phone, and phone-to-phone services connecting via TCP/IP networks.</p>

## 43.8 Web Content Filter Example

This is an example of using the Zyxel Device to block access to a specific network service. A company wants to prevent its employees from using Facebook during their time in the office, but still allows access to other web pages, such as Office 365, Google, Wikipedia... The company wants to make sure any traffic going from the LAN to the Internet cannot access Facebook whether the traffic goes through the Zyxel Device or not.

Figure 32 Web Content Filter Example

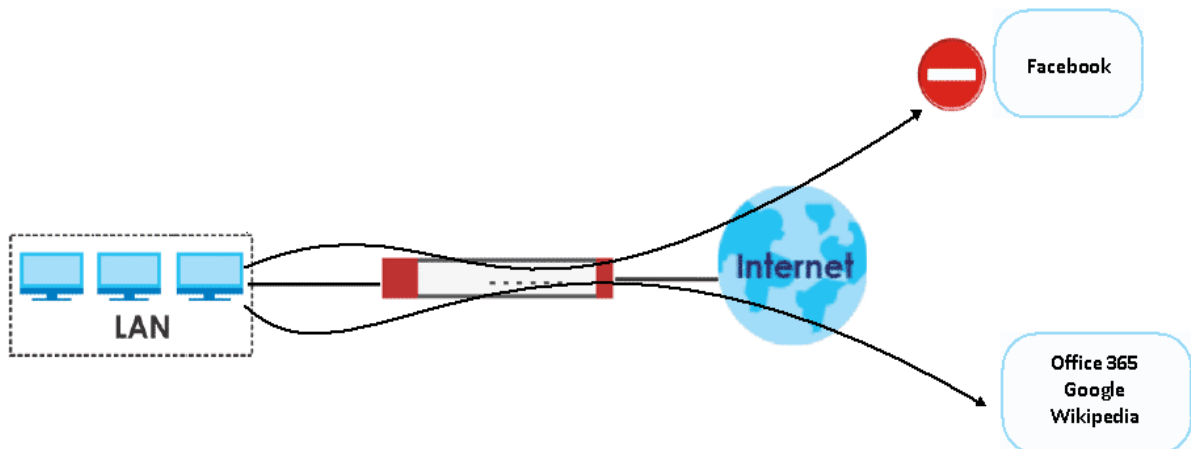

Follow the steps below to block the Zyxel Device LAN users from accessing Facebook.

- 1 Create a web content filter profile named **facebook\_block**.

```
Router# configure terminal
Router(config)# content-filter profile facebook_block
```

- 2 You then enter sub-command mode for the **facebook\_block** profile to configure the web content filter profile's list of forbidden keywords.

```
Router(config)# content-filter profile facebook_block custom-list keyword
Router(Host)#
;      <cr>  exit   no      url    |
```

- 3 Enter **\*.facebook\*.com** to block access to websites with URLs that contain **facebook**. Use asterisks (\*) as a wildcard to match any string in trusted and forbidden websites. Exit sub-command mode.

```
Router(Host)# url *.facebook*.com
Router(Host)# exit
```

- 4 To block traffic that goes through the Zyxel Device from the LAN to the Internet, you need to apply the web content filter profile **facebook\_block** to the security policies **LAN1\_Outgoing** and **LAN2\_Outgoing**. Enter sub-command mode for configuring the security policy **LAN1\_Outgoing**.

```
Router(config)# secure-policy 1
```

- 5 Apply the web content filter profile **facebook\_block** to the security policies' web content filter profile. Set the log to **log by-profile** to generate a log for all traffic that matches criteria in the profile. Exit sub-command mode.

```
Router(secure-policy)# cf-profile
<profile name>
Router(secure-policy)# cf-profile facebook_block
log no
Router(secure-policy)# cf-profile facebook_block log by-profile
activate deactivate
Router(secure-policy)# cf-profile facebook_block log by-profile activate
Router(secure-policy)# exit
```

- 6 Repeat step 7 and step 8 to apply the web content filter profile **facebook\_block** to the security policy **LAN2\_Outgoing**.

## 43.9 DNS Content Filter Example

This is an example of using the Zyxel Device to block access to a specific network service. A company wants to prevent its employees from using social networks during their time in the office, such as Facebook, Instagram, Twitter... The company wants to make sure any traffic going from the LAN to the Internet cannot access social networks whether the traffic goes through the Zyxel Device or not.

Figure 33 DNS Content Filter Example

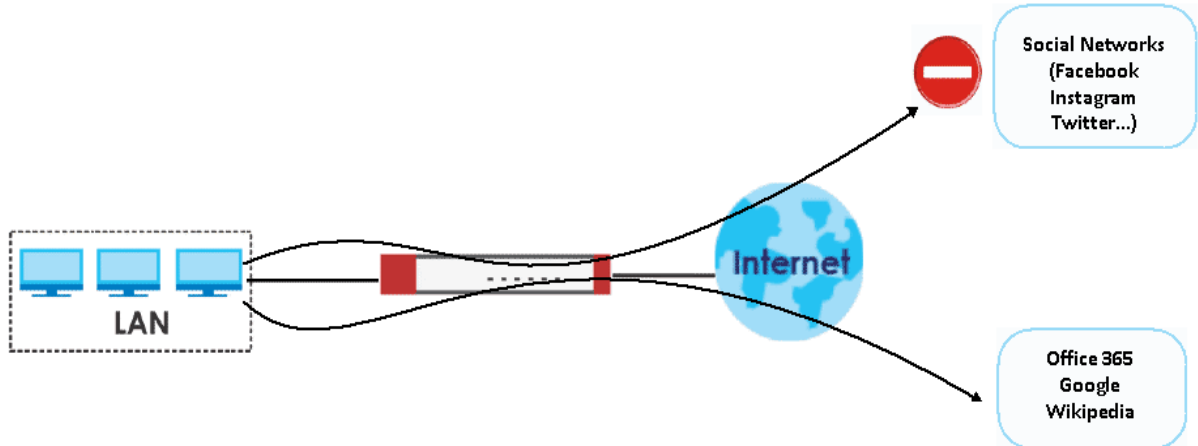

Follow the steps below to block the Zyxel Device LAN users from accessing social networks.

- 1 Create a DNS content filter profile named **SocialNetworks**.

```
Router# configure terminal
Router(config)# dns-content-filter profile SocialNetworks
```

- 2 You then enter sub-command mode for the **SocialNetworks** profile to configure the DNS content filter profile's forbidden categories. Sets the category to **social-networking** to block all social networks.

```

Router(config-dns-content-filter-profile-SocialNetworks)# category
adult-topics                cult-occult                forum-bulletin-
boards                      illegal-uk                media-sharing
pharmacy                    pups                      shareware-
freeware                    usenet-news
alcohol                     dating-personals         gambling
incidental-nudity          messaging                politics-
opinion                     real-estate              social-networking
violence
anonymizing-utilities      dating-social-networking  gambling-
related                    information-security      mobile-phone
pornography                recreation-hobbies        software-
hardware                   visual-search-engine
art-culture-heritage      digital-postcards        game-cartoon-
violence                   information-security-new  moderated
portal-sites               religion-ideology         sports
weapons
auctions-classifieds      discrimination            games
instant-messaging         motor-vehicles            potential-
criminal-activities       remote-access            stock-trading
web-ads
blogs-wiki                 drugs                    general-news
interactive-web-applications  non-profit-advocacy-ngo  potential-
hacking-computer-crime    reserved                 streaming-media
web-mail
business                   education-reference      government-
military                   internet-radio-tv        nudity
potential-illegal-software  residential-ip-addresses  technical-
business-forums            web-meetings
chat                       entertainment            gruesome-
content                     internet-services        online-shopping
private-ip-addresses      resource-sharing          technical-
information                web-phone
computing-internet        extreme                  health
job-search                 p2p-file-sharing         profanity
restaurants                text-spoken-only
consumer-protection        fashion-beauty           historical-
revisionism                 major-global-religions   parked-domain
professional-networking    school-cheating-information  text-
translators
content-server             finance-banking           history
marketing-merchandising   personal-network-storage  provocative-
attire                     search-engines            tobacco
controversial-opinions    for-kids                  humor-comics
media-downloads           personal-pages            public-
information                sexual-materials          travel
Router(config-dns-content-filter-profile-SocialNetworks)# category social-
networking

```

- 3 Sets the action to **redirect** to redirect users that try to access FQDNs that are categorized as social networks. Sets the **log** to log to generate a log for all traffic that matches criteria in the profile. Exit sub-command mode.

```
Router(config-dns-content-filter-profile-SocialNetworks)# action redirect
Router(config-dns-content-filter-profile-SocialNetworks)# log
Router(Host)# exit
```

- 4 To block traffic that goes through the Zyxel Device from the LAN to the Internet, you need to apply the DNS content filter profile **SocialNetworks** to security policies **LAN1\_Outgoing** and **LAN2\_Outgoing**. Enter sub-command mode for configuring the security policy **LAN1\_Outgoing**.

```
Router(config)# secure-policy 1
```

- 5 Apply the DNS content filter profile **SocialNetworks** to the security policies' DNS content filter profile. Set the log to **log by-profile** to generate a log for all traffic that matches criteria in the profile. Exit sub-command mode.

```
Router(secure-policy)# dns-cf-profile
<profile name>
Router(secure-policy)# dns-cf-profile SocialNetworks
log no
Router(secure-policy)# dns-cf-profile SocialNetworks log by-profile
activate deactivate
Router(secure-policy)# dns-cf-profile SocialNetworks log by-profile
activate
Router(secure-policy)# exit
```

- 6 Repeat step 7 and step 8 to apply the DNS content filter profile **SocialNetworks** to the security policy **LAN2\_Outgoing**.

# CHAPTER 44

## Anti-Spam

This chapter introduces and shows you how to configure the anti-spam scanner.

### 44.1 Anti-Spam Overview

The anti-spam feature marks or discards spam. Activate the anti-spam subscription service for sender IP reputation checking, mail content analysis, and virus outbreak detection. Use the white list to identify legitimate e-mail. Use the black list to identify spam e-mail. You can also check e-mail against a DNS black list (DNSBL) of IP addresses of servers suspected of being used by spammers.

Note: From firmware version 4.60 onwards, the anti-spam provider is McAfee. This means some anti-spam commands changed in firmware versions 4.60 and later.

### 44.2 Anti-Spam Commands

The following table identifies the values used in some of these commands. Other input values are discussed with the corresponding commands.

Table 209 Input Values for General Anti-Spam Commands

LABEL	DESCRIPTION
<i>xheader-name</i>	The name (part that comes before the colon) of a field to add to an e-mail header. Use up to 16 ASCII characters.
<i>xheader-value</i>	The value (part that comes after the colon) of a field to add to an e-mail header. Use up to 16 ASCII characters.

#### 44.2.1 Anti-Spam Profile Rules

The following table describes the commands for configuring the zone to zone rules. You must use the `configure terminal` command to enter the configuration mode before you can use these commands.

Table 210 Commands for Anti-Spam Profile Rules

COMMAND	DESCRIPTION
<code>anti-spam profile append</code>	Enters the anti-spam sub-command mode to append a profile.
<code>anti-spam profile insert rule_number</code>	Enters the anti-spam sub-command mode to insert a profile.
<code>anti-spam profile rule_number</code>	Enters the anti-spam sub-command mode to edit the specified direction specific rule.

Table 210 Commands for Anti-Spam Profile Rules (continued)

COMMAND	DESCRIPTION
[no] log [alert]	Sets the Zyxel Device to create a log (and optionally an alert) when packets match this rule and are found to be spam. The no command sets the Zyxel Device not to create a log or alert when packets match this rule.
[no] scan {smtp   pop3}	Sets the protocols of traffic to scan for spam.
[no] match-action pop3 {forward   forward-with-tag}	Sets the action to take when the Zyxel Device detects a spam POP3 e-mail. The file can be forwarded or forwarded with a spam tag.
[no] match-action smtp {drop   forward   forward-with-tag}	Sets the action to take when the Zyxel Device detects a spam SMTP e-mail. The file can be deleted, forwarded, or forwarded with a spam tag.
[no] bypass {white-list   black-list   dnsbl}	Bypassing has the Zyxel Device not check files against your configured white (allowed) list, black (spam) list, or DNSBL servers list.
[no] bypass {ip-reputation   mail-content   virus-outbreak}	Firmware 4.55 or earlier Has the Zyxel Device not check mail's IP reputation, content, or for viruses.
[no] bypass mail-phishing	Firmware 4.60 or later Has the Zyxel Device not check emails for suspicious links.
show	Displays the details of the anti-spam rule you are configuring.
anti-spam profile move <i>rule_number</i> to <i>rule_number</i>	Moves an anti-spam profile to the number that you specified.
anti-spam profile delete <i>rule_number</i>	Removes an anti-spam profile.
show anti-spam profile [ <i>rule_number</i> ]	Displays the details of all the configured anti-spam profiles.
[no] anti-spam ip-reputation activate	Firmware 4.55 or earlier Sets whether or not to use IP reputation to identify spam by the sender's IP address.
anti-spam ip-reputation query-timeout time [ <i>timeout</i> ]	Firmware 4.55 or earlier Sets how many seconds the Zyxel Device waits for a reply when checking the IP reputation of a sender's IP address.
anti-spam ip-reputation statistics flush	Firmware 4.55 or earlier Clears the anti-spam statistics showing how many emails were detected as spam using the IP Reputation filter.
[no] anti-spam ip-reputation private-check activate	Firmware 4.55 or earlier Sets whether or not to check the IP reputation of private sender IP addresses.
[no] anti-spam mail-content activate	Firmware 4.55 or earlier Sets whether or not to identify spam by content, such as malicious content.
[no] anti-spam mail-phishing activate	Sets whether or not to identify emails sent from suspicious websites known for phishing.

Table 210 Commands for Anti-Spam Profile Rules (continued)

COMMAND	DESCRIPTION
<code>anti-spam tag {mail-content   mail-phishing   virus-outbreak} [tag]</code>	Firmware 4.55 or earlier Specifies the labels to add to the beginning of the mail subject if content-analysis identified it as spam, the e-mail has suspicious websites links or it contains a virus.
<code>anti-spam tag mail-phishing [tag]</code>	Firmware 4.60 or later Specifies the label to add to the beginning of an email subject if the email contains suspicious websites links.
<code>[no] anti-spam virus-outbreak activate</code>	Firmware 4.55 or earlier Sets whether or not to scan emails for attached viruses.
<code>anti-spam xheader {mail-content   virus-outbreak} xheader-name xheader-value</code>	Firmware 4.55 or earlier Specifies the name and value for the X-Header to add to content-analysis identified spam or e-mails containing a virus.
<code>no anti-spam xheader {mail-content   virus-outbreak}</code>	Firmware 4.55 or earlier The Zyxel Device does not add an X-header to content-analysis identified spam or e-mails containing a virus.
<code>anti-spam xheader mail-phishing xheader-name xheader-value</code>	Firmware 4.60 or later Specifies the name and value for the X-Header to emails containing suspicious websites links.
<code>no anti-spam xheader mail-phishing</code>	Firmware 4.60 or later The Zyxel Device does not add an X-header to content-analysis identified spam or e-mails containing a virus.
<code>anti-spam mail-scan query-timeout pop3 {forward   forward-with-tag}</code>	Selects how to handle POP3 mail if querying the mail scan server times out. Use <code>forward</code> to send it or <code>forward-with-tag</code> to add a tag to the mail subject and send it.
<code>anti-spam mail-scan query-timeout smtp {drop   forward   forward-with-tag}</code>	Selects how to handle SMTP mail if querying the mail scan server times out. Use <code>drop</code> to discard the SMTP mail, <code>forward</code> to send it, or <code>forward-with-tag</code> to add a tag to the mail subject and send it.
<code>anti-spam mail-phishing query-timeout smtp {drop   forward   forward-with-tag}</code>	Firmware 4.60 or later Selects how to handle SMTP mail if querying the mail phishing scan server times out. Use <code>drop</code> to discard the SMTP mail, <code>forward</code> to send it, or <code>forward-with-tag</code> to add a tag to the mail subject and send it.
<code>anti-spam mail-phishing query-timeout pop3 {forward   forward-with-tag}</code>	Firmware 4.60 or later Selects how to handle POP3 mail if querying the mail phishing scan server times out. Use <code>drop</code> to discard the POP3 mail, <code>forward</code> to send it, or <code>forward-with-tag</code> to add a tag to the mail subject and send it.
<code>anti-spam mail-phishing query-timeout time [timeout]</code>	Firmware 4.60 or later Sets how many seconds the Zyxel Device waits for a reply from the phishing scan server before taking the relevant timeout action.
<code>anti-spam mail-scan query-timeout time [timeout]</code>	Sets how many seconds the Zyxel Device waits for a reply from the mail scan server before taking the relevant timeout action.
<code>anti-spam tag query-timeout [tag]</code>	Specifies the label to add to the mail subject of e-mails the Zyxel Device tags and forwards when queries to the mail scan servers time out.



Table 210 Commands for Anti-Spam Profile Rules (continued)

COMMAND	DESCRIPTION
[no] anti-spam xheader query-timeout <i>xheader-name xheader-value</i>	Specifies the name and value for the X-Header to add to e-mails the Zyxel Device forwards when queries to the mail scan servers time out.
show anti-spam ip-reputation query-timeout <i>time</i>	Firmware 4.55 or earlier Displays how many seconds the Zyxel Device waits for a reply when checking the IP reputation of a sender's IP address.
show anti-spam ip-reputation private-check	Firmware 4.55 or earlier Displays the setting for checking the IP reputation of private sender IP addresses.
show anti-spam ip-reputation high-sensitivity	Firmware 4.55 or earlier Displays whether IP reputation high sensitivity mode is enabled or not.
show anti-spam mail-scan query-timeout smtp	Displays the action the Zyxel Device takes on SMTP mail if querying the mail scan server times out.
show anti-spam mail-scan query-timeout pop3	Displays the action the Zyxel Device takes on POP3 mail if querying the mail scan server times out.
show anti-spam mail-scan query-timeout <i>time</i>	Displays how many seconds the Zyxel Device waits for a reply from the mail scan server before taking the relevant timeout action.
show anti-spam mail-phishing query-timeout smtp	Firmware 4.60 or later Displays the action the Zyxel Device takes on SMTP mail if querying the phishing scan server times out.
show anti-spam mail-phishing query-timeout pop3	Firmware 4.60 or later Displays the action the Zyxel Device takes on POP3 mail if querying the phishing scan server times out.
show anti-spam mail-phishing query-timeout <i>time</i>	Firmware 4.60 or later Displays how many seconds the Zyxel Device waits for a reply from the phishing scan server before taking the relevant timeout action.
show anti-spam mail-scan status	Firmware 4.55 or earlier Displays the Zyxel Device's settings for IP reputation, mail content, and virus outbreak checking.
show anti-spam mail-phishing status	Firmware 4.60 or later Displays whether the Zyxel Device scans emails for suspicious websites links.
show anti-spam tag {mail-content   mail-phishing   virus-outbreak}	Firmware 4.55 or earlier Displays the labels for content-analysis identified spam, e-mails that have suspicious websites links or emails containing a virus.
show anti-spam tag mail-phishing	Firmware 4.60 or later Displays the labels for content-analysis identified emails containing suspicious websites links.
show anti-spam tag query-timeout	Displays the label the Zyxel Device adds to the mail subject of e-mails that it tags and forwards when queries to the mail scan servers time out.

Table 210 Commands for Anti-Spam Profile Rules (continued)

COMMAND	DESCRIPTION
<code>show anti-spam xheader {mail-content   mail-phishing   virus-outbreak}</code>	Firmware 4.55 or earlier Displays the name and value for the X-Header to add to content-analysis identified spam, e-mails containing suspicious websites links or e-mails containing a virus.
<code>show anti-spam xheader mail-phishing</code>	Firmware 4.60 or later Displays the name and value for the X-Header to add to content-analysis identified e-mails containing suspicious websites links.
<code>show anti-spam xheader query-timeout</code>	Displays the name and value for the X-Header the Zyxel Device adds to e-mails that it tags and forwards when queries to the mail scan servers time out.
<code>[no] security-service anti-spam activate</code>	Turns on anti-spam/email security on the Zyxel Device. The <code>no</code> command disables anti-spam/email security.
<code>security-service anti-spam inspect {all-traffic   by-policy}</code>	Sets how the security service inspects traffic. <i>all-traffic</i> : The security service inspects all traffic passing through the Zyxel Device. <i>by-policy</i> : The security service inspects traffic only when its profile is bound to a security policy. For information on binding a security service profile to a security policy, see <a href="#">Section 29.2.1 on page 219</a> .
<code>show security-service status</code>	Displays whether the security services are enabled on the Zyxel Device.

#### 44.2.1.1 Anti-Spam Profile Example

This example shows how to configure (and display) a WAN to DMZ anti-spam profile to scan POP3 and SMTP traffic. SMTP spam is forwarded. POP3 spam is marked with a spam tag. The Zyxel Device logs the

event when an e-mail matches the DNSBL (see [Section 44.2.3 on page 397](#) for more on DNSBL). The white and black lists are ignored.

```
Router(config)# anti-spam 1
Router(config-as-rule-1)# activate
Router(config-as-rule-1)# scan smtp
Router(config-as-rule-1)# scan pop3
Router(config-as-rule-1)# match-action smtp forward
Router(config-as-rule-1)# match-action pop3 forward-with-tag
Router(config-as-rule-1)# log
Router(config-as-rule-1)# bypass white-list
Router(config-as-rule-1)# bypass black-list
Router(config-as-rule-1)# exit
Router(config)# show anti-spam 1
Anti-Spam Rule: 1
  profile name: AS_profile_default_SXI
  description:
  log: log
  scan protocols:
    smtp: yes
    pop3: yes
  match action:
    smtp: forward-with-tag
    pop3: forward-with-tag
  bypass white list: no
  bypass black list: no
  bypass ip reputation: no
  bypass mail content: no
  bypass virus outbreak: no
  bypass dnsbl: no
  ref: 0
```

## 44.2.2 White and Black Lists

The following table identifies values used in these commands. Other input values are discussed with the corresponding commands.

Table 211 Input Values for White and Black list Anti-Spam Commands

LABEL	DESCRIPTION
<i>mail_header</i>	The name part of an e-mail header (the part that comes before the colon). Use up to 63 ASCII characters.  For example, if you want the entry to check the "Received:" header for a specific mail server's domain, use "Received".
<i>mail_header_value</i>	The value part of an e-mail header (the part that comes after the colon). Use up to 63 ASCII characters.  For example, if you want the entry to check the "Received:" header for a specific mail server's domain, specify the mail server's domain.  See <a href="#">Section 44.2.2.2 on page 397</a> for more details.
<i>rule_number</i>	The index number of an anti-spam white or black list entry. 1 - <i>X</i> where <i>X</i> is the highest number of entries the Zyxel Device model supports. See the Zyxel Device's User's Guide for details.
<i>subject</i>	A keyword in the content of the e-mail Subject headers. Use up to 63 ASCII characters. Spaces are not allowed, although you could substitute a question mark (?). See <a href="#">Section 44.2.2.2 on page 397</a> for more details.

Use the white list to identify legitimate e-mail and the black list to identify spam e-mail. The following table describes the commands for configuring the white list and black list. You must use the `configure terminal` command to enter the configuration mode before you can use these commands.

Table 212 Commands for Anti-Spam White and Black Lists

COMMAND	DESCRIPTION
[no] anti-spam white-list activate	Turns the white list checking on or off. Turn on the white list to forward e-mail that matches (an active) white list entry without doing any more anti-spam checking on that individual e-mail.
[no] anti-spam white-list [rule_number] ip-address ip subnet_mask {activate deactivate}	Adds, edits, or removes a white list entry to check e-mail for a specific source or relay IPv4 address. Also turns the entry on or off.
[no] anti-spam white-list [rule_number] ip6-address ipv6_subnet {activate deactivate}	Adds, edits, or removes a white list entry to check e-mail for a specific source or relay IPv6 address. Also turns the entry on or off.
[no] anti-spam white-list [rule_number] e-mail email {activate deactivate}	Adds, edits, or removes a white list entry to check e-mail for a specific source e-mail address or domain name. Also turns the entry on or off.
[no] anti-spam white-list [rule_number] mail-header mail-header mail-header-value {activate deactivate}	Adds, edits, or removes a white list entry to check e-mail for specific header fields and values. Also turns the entry on or off.
[no] anti-spam white-list [rule_number] subject subject {activate deactivate}	Adds, edits, or removes a white list entry to check e-mail for specific content in the subject line. Also turns the entry on or off.
[no] anti-spam black-list activate	Turns the black list checking on or off. Turn on the black list to treat e-mail that matches (an active) black list entry as spam.
[no] anti-spam black-list [rule_number] ip-address ip subnet_mask {activate deactivate}	Adds, edits, or removes a black list entry to check e-mail for a specific source or relay IPv4 address. Also turns the entry on or off.
[no] anti-spam black-list [rule_number] ip6-address ipv6_subnet {activate deactivate}	Adds, edits, or removes a black list entry to check e-mail for a specific source or relay IPv6 address. Also turns the entry on or off.
[no] anti-spam black-list [rule_number] e-mail email {activate deactivate}	Adds, edits, or removes a black list entry to check e-mail for a specific source e-mail address or domain name. Also turns the entry on or off.
[no] anti-spam black-list [rule_number] mail-header mail-header mail-header-value {activate deactivate}	Adds, edits, or removes a black list entry to check e-mail for specific header fields and values. Also turns the entry on or off.
[no] anti-spam black-list [rule_number] subject subject {activate deactivate}	Adds, edits, or removes a black list entry to check e-mail for specific content in the subject line. Also turns the entry on or off.
anti-spam tag black-list [tag]	Configures a message or label (up to 15 ASCII characters) to add to the mail subject of e-mails that match an anti-spam black list entry.
show anti-spam white-list [status]	Displays the current anti-spam white list. Use <code>status</code> to show the activation status only.
show anti-spam black-list [status]	Displays the current anti-spam black list. Use <code>status</code> to show the activation status only.
show anti-spam tag black-list	Shows the configured anti-spam black list tag.

Table 212 Commands for Anti-Spam White and Black Lists (continued)

COMMAND	DESCRIPTION
[no] anti-spam xheader {white-list   black-list} mail-header mail-header-value	Specifies the name and value for the X-Header to add to e-mails that match the Zyxel Device's spam white list or black list.
show anti-spam xheader {white-list   black-list}	Displays the name and value for the X-Header to add to e-mails that match the Zyxel Device's spam white list or black list.

### 44.2.2.1 White and Black Lists Example

This example shows how to configure and enable a white list entries for e-mails with "testwhite" in the subject, e-mails from whitelist@ourcompany.com, e-mails with the Date header set to 2007, and e-mails from (or forwarded by) IP address 192.168.1.0 with subnet 255.255.255.0.

```
Router(config)# anti-spam white-list subject testwhite activate
Router(config)# anti-spam white-list e-mail whitelist@ourcompany.com
activate
Router(config)# anti-spam white-list mail-header Date 2007 activate
Router(config)# anti-spam white-list ip-address 192.168.1.0 255.255.255.0
activate
Router(config)# show anti-spam white-list
No.   Type           Status
Content
=====
1     subject        yes
testwhite
2     e-mail         yes
whitelist@ourcompany.com
3     mail-header    yes
Date : 2007
4     ip-address     yes
192.168.1.0 / 255.255.255.0
```

### 44.2.2.2 Regular Expressions in Black or White List Entries

The following applies for a black or white list entry based on an e-mail subject, e-mail address, or e-mail header value.

- Use a question mark (?) to let a single character vary. For example, use "a?c" (without the quotation marks) to specify abc, acc and so on.
- You can also use a wildcard (\*). For example, if you configure \*def.com, any e-mail address that ends in def.com matches. So "mail.def.com" matches.
- The wildcard can be anywhere in the text string and you can use more than one wildcard. You cannot use two wildcards side by side, there must be other characters between them.
- The Zyxel Device checks the first header with the name you specified in the entry. So if the e-mail has more than one "Received" header, the Zyxel Device checks the first one.

### 44.2.3 DNSBL Anti-Spam Commands

This section describes the commands for checking the sender and relay IP addresses in e-mail headers against DNS (Domain Name Service)-based spam Black Lists (DNSBLs). You must use the `configure terminal` command to enter the configuration mode before you can use these commands.

The following table identifies the values required for many of these commands. Other input values are discussed with the corresponding commands.

Table 213 Input Values for DNSBL Commands

LABEL	DESCRIPTION
<i>dnsbl_domain</i>	A domain that is maintaining a DNSBL. You may use 0-254 alphanumeric characters, or dashes (-).

This table describes the DNSBL commands.

Table 214 DNSBL Commands

COMMAND	DESCRIPTION
[no] anti-spam dnsbl activate	Turns DNSBL checking on or off.
anti-spam dnsbl [1..5] domain <i>dnsbl_domain</i> {activate deactivate}	Adds or edits a DNSBL domain for checking e-mail header IP addresses.
no anti-spam dnsbl domain <i>dnsbl_domain</i>	Removes the specified DNSBL domain.
anti-spam dnsbl query-timeout smtp {drop   forward   forward-with-tag}	Sets how the Zyxel Device handles SMTP mail (mail going to an e-mail server) if the queries to the DNSBL domains time out.
anti-spam dnsbl query-timeout pop3 {forward   forward-with-tag}	Sets how the Zyxel Device handles POP3 mail (mail coming to an e-mail client) if the queries to the DNSBL domains time out.
anti-spam dnsbl max-query-ip [1..5]	Sets up to how many sender and relay server IP addresses in the mail header to check against the DNSBL.
anti-spam dnsbl ip-check-order {forward   backward}	Configures the order in which anti-spam checks e-mail header IP addresses against the DNSBLs. <ul style="list-style-type: none"> <li><i>forward</i> checks the first N IP addresses. Checking starts from the first IP address in the mail header. This is the IP of the sender or the first server that forwarded the mail.</li> <li><i>backward</i> checks the last N IP addresses. Checking starts from the last IP address in the mail header. This is the IP of the last server that forwarded the mail.</li> </ul>
anti-spam tag {dnsbl   dnsbl-timeout} [ <i>tag</i> ]	<i>dnsbl</i> configures the message or label to add to the beginning of the mail subject of e-mails that have a sender or relay IP address in the header that matches a black list maintained by a DNSBL domain listed in the Zyxel Device.  <i>dnsbl-timeout</i> configures the message or label to add to the mail subject of e-mails that the Zyxel Device forwards if queries to the DNSBL domains time out.  Use up to 15 alphanumeric characters, underscores (_), colons (:), or dashes (-).
show anti-spam dnsbl status	Displays the activation status of the anti-spam DNSBL checking.
show anti-spam dnsbl domain	Displays the Zyxel Device's configured anti-spam DNSBL domain entries.
show anti-spam dnsbl max-query-ip	Displays how many sender and relay server IP addresses in the mail header anti-spam checks against the DNSBL.
show anti-spam dnsbl ip-check-order	Displays the order in which anti-spam checks e-mail header IP addresses against the DNSBLs.
show anti-spam dnsbl query-timeout {smtp   pop3}	Displays how the Zyxel Device handles SMTP or POP3 mail if the queries to the DNSBL domains time out.

Table 214 DNSBL Commands

COMMAND	DESCRIPTION
<code>show anti-spam tag {dnsbl   dnsbl-timeout}</code>	<code>dnsbl</code> displays the anti-spam tag for e-mails that have a sender or relay IP address in the header that matches a black list maintained by a DNSBL domain.  <code>dnsbl-timeout</code> displays the message or label to add to the mail subject of e-mails that the Zyxel Device forwards if queries to the DNSBL domains time out.
<code>show anti-spam dnsbl statistics</code>	Displays anti-spam DNSBL statistics for each configured DNSBL domain.
<code>anti-spam dnsbl statistics flush</code>	Clears the anti-spam DNSBL statistics for each configured DNSBL domain.
<code>anti-spam dnsbl query-timeout time [1..10]</code>	Sets how long the Zyxel Device waits for a reply from the DNSBL domains.
<code>show anti-spam dnsbl query-timeout time</code>	Displays how long the Zyxel Device waits for a reply from the DNSBL domains.
<code>[no] anti-spam xheader dnsbl mail-header mail-header-value</code>	Specify the name and value for the X-Header to add to e-mails with a sender or relay IP address in the header that matches a black list maintained by a DNSBL domain in the Zyxel Device's list
<code>show anti-spam xheader dnsbl</code>	Display the name and value for the X-Header to add to e-mails with a sender or relay IP address in the header that matches a black list maintained by a DNSBL domain in the Zyxel Device's list

### 44.2.3.1 DNSBL Example

This example:

- Sets the Zyxel Device to use "DNSBL-example.com" as a DNSBL.
- Turns DNSBL checking on.
- Sets the Zyxel Device to forward POP3 mail with a tag if the queries to the DNSBL domains time out.
- Sets the Zyxel Device to check up to 4 sender and relay server IP addresses in e-mail headers against the DNSBL.
- Sets the Zyxel Device to start DNSBL checking from the first IP address in the mail header.
- Sets the DNSBL tag to "DNSBL".
- Sets the DNSBL timeout tag to "DNSBL-timeout".

- Displays the DNSBL statistics.

```

Router(config)# anti-spam dnsbl domain DNSBL-example.com activate
Router(config)# show anti-spam dnsbl domain
No.    Status
Domain
=====
1      yes
DNSBL-example.com
Router(config)# anti-spam dnsbl activate
Router(config)# show anti-spam dnsbl status
anti-spam dnsbl status: yes
Router(config)# anti-spam dnsbl query-timeout pop3 forward-with-tag
Router(config)# show anti-spam dnsbl query-timeout pop3
dnsbl query timeout action: forward-with-tag
Router(config)# anti-spam dnsbl max-query-ip 4
Router(config)# show anti-spam dnsbl max-query-ip
dnsbl max query ip: 4
Router(config)# anti-spam dnsbl ip-check-order forward
Router(config)# show anti-spam dnsbl ip-check-order
anti-spam dnsbl IP check order: forward
Router(config)# anti-spam tag dnsbl DNSBL
Router(config)# show anti-spam tag dnsbl
dnsbl tag: DNSBL
Router(config)# anti-spam tag dnsbl-timeout DNSBL-timeout
Router(config)# show anti-spam tag dnsbl-timeout
dnsbl-timeout tag: DNSBL-timeout
Router(config)# show anti-spam dnsbl statistics
DNSBL domain: 1
  domain: DNSBL-example.com
  average time: 0.00
  total query: 0
    spam: 0
    clear: 0
    no timeout: 0
    timeout: 0
    no response: 0

```

## 44.3 Anti-Spam Statistics

The following table describes the commands for collecting and displaying anti-spam statistics. You must use the `configure terminal` command to enter the configuration mode before you can use these commands.

Table 215 Commands for Anti-Spam Statistics

COMMAND	DESCRIPTION
[no] anti-spam statistics collect	Turn the collection of anti-spam statistics on or off.
anti-spam statistics flush	Clears the collected statistics.
show anti-spam statistics summary	Displays an overview of the collected statistics.
show anti-spam statistics collect	Displays whether the collection of anti-spam statistics is turned on or off.



Table 215 Commands for Anti-Spam Statistics (continued)

COMMAND	DESCRIPTION
<code>show anti-spam statistics ranking {source   mail-address}</code>	Query and sort the anti-spam statistics entries by source IP address or mail address.  source: lists the source IP addresses of the most spam. mail-address: lists the most common source mail address for spam.
<code>show anti-spam ip-reputation statistics</code>	Firmware 4.55 or earlier Displays the mail sender IP reputation checking statistics.
<code>show anti-spam mail-scan statistics</code>	Displays the mail scan statistics.

### 44.3.1 Anti-Spam Statistics Example

This example shows how to collect anti-spam statistics and display a summary.

```
Router(config)# anti-spam statistics collect
Router(config)# show anti-spam statistics collect
collect statistics: yes
collect statistics time: since 2008-03-11 07:16:01 to 2008-03-11 07:16:13
Router(config)# show anti-spam statistics summary
total mails scanned: 0
total clear mails: 0
clear mail by whitelist: 0
total spam mails: 0
spam detected by blacklist: 0
spam detected by ip reputation: 0
spam detected by mail content: 0
spam detected by dnsbl: 0
spam detected with virus: 0
total virus mails: 0
dnsbl timeout: 0
mail session forwarded: 0
mail session dropped: 0
```

# CHAPTER 45

# Collaborative Detection & Response

## 45.1 Overview

Collaborative Detection & Response (CDR) allows you to detect wired and WiFi clients that are sending malicious traffic in your network and then block or quarantine traffic coming from them. In this way, malicious traffic is not spread throughout the network. Secure policies can block malicious traffic for specific traffic flows, but CDR can block malicious traffic from the sender. Malicious traffic is identified using a combination of Web Filtering, Anti-Malware and IPS (IDP) signatures.

### 45.1.1 CDR Example Scenario

In the following example scenario, clients C1 to C6 are connected to the network. Intrusion Prevention (IPS) or Anti-Malware signatures have identified malicious traffic coming from clients C1, C2, C4 and C5.

You have configured CDR to take the following actions:

- Traffic from WiFi client C1 is blocked at the AP.
- Traffic from WiFi client C2 is blocked at the Zyxel Device.
- Traffic from wired client C5 is blocked at the Zyxel Device. This traffic can still be broadcast to other clients in the same subnet, such as C6.
- Traffic from WiFi client C4 is isolated from the network through a quarantine VLAN. Quarantined traffic in a VLAN isolates traffic from other clients in the same subnet, and only broadcasts to other clients in that same VLAN.

Figure 34 CDR Example Scenario

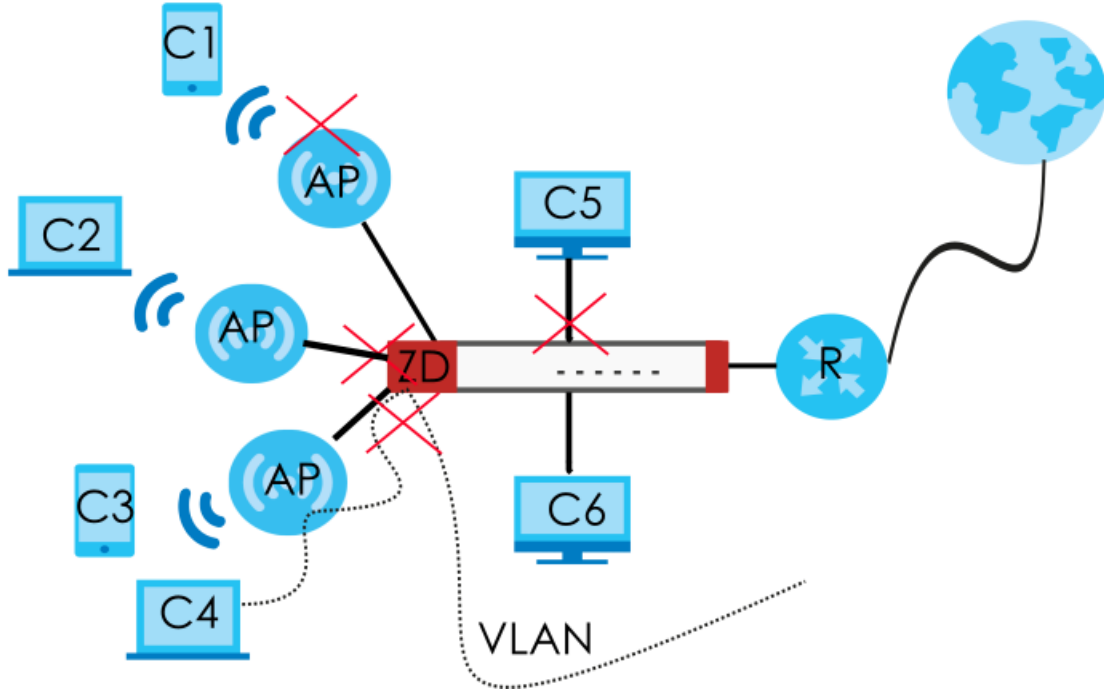

This the graphic key.

Table 216 CDR Example Scenario Graphic Key

LABEL	DEFINITION
C1 to C4	WiFi clients
C5 to C6	Wired clients
AP	Access Point
S	VLAN-aware Switch
ZD	Zyxel Device
R	Router giving access to the Internet
VLAN	VLAN configured to isolate traffic from a quarantined client

## 45.2 Before You Begin

- You must have active and up-to-date Web Filtering, Anti-Malware, IPS (Intrusion Prevention System), and CDR (Collaborative Detection & Response) licenses.
- Malicious traffic is detected in two phases.
  - Web Filtering (URL Threat Filtering), Anti-Malware (Anti-Virus) and IPS (IDP) signatures first identify malicious traffic and inform the CDR daemon. If these licenses have expired or are not active, then no checking for malicious traffic is done.

- CDR signatures are a subset of the above license signatures. If a specific number of signature matches are detected within a defined time period, then the CDR containment policy is triggered. These are the signatures that apply to CDR at the time of writing:

Table 217 Security Signatures Applied to CDR

SECURITY SIGNATURES	SIGNATURES APPLIED TO CDR
Web Filtering	URL Threat Filter Categories: Browser Exploits, Malicious Downloads, Malicious Sites, Phishing
IPS	IDP Signatures: <ul style="list-style-type: none"> <li>• CVE-2019-0708 (117760, 130797, 130801)</li> <li>• CVE-2020-0796(130822,130823,130824,130825)</li> <li>• 117723, 117724, 117726</li> </ul>
Anti-Malware	All signatures

- Blocking traffic from an infected client causes the Zyxel Device to drop all traffic received from the client. This traffic can still be broadcast to other clients in the same subnet as the infected client.
- Blocking traffic from an infected WiFi client causes the AP it is connected with to drop all traffic received from the client if you run command `cdr block block-wireless-client`.
- The Zyxel Device can only block traffic from Nebula-managed APs in your network using CDR.
- Quarantining traffic from an infected WiFi client blocks traffic at the Zyxel Device or AP and also isolates traffic from other clients in the same subnet. Traffic from the infected WiFi is only broadcast to other clients in the quarantine VLAN. You must configure the quarantine VLAN on the Zyxel Device and any switches or routers in your network through which you want to route the VLAN traffic.
- There are 2 requirements to block or quarantine WiFi clients:
  - The AP must be managed by the Zyxel Device.
  - The AP must be in the Zyxel Device's supported list. At the time of writing, there are 5 supported AP models:

Table 218 Zyxel Device Managed APs

MANAGED AP MODELS
• WAX650S
• WAX610D
• WAX510D
• WAC500
• WAC500H

Note: Please see your AP product page at the Zyxel web site to see if it can be managed by the Zyxel Device.

- You must decide how long to contain (block or quarantine) a suspect client, before allowing traffic to be sent from it again. This will depend on how quickly you can contact the owner of the suspect client and how long they need to remove the malicious software from their device.
- You must also decide if there are trusted clients in your network that are exempt from CDR and never have their traffic blocked or quarantined.
- You can use the `cdr unblock` commands to prematurely release a blocked or quarantined client, and the `cdr white-list` commands to add a client to a list exempt from CDR checking.
- If you disable CDR or your CDR license expires, then all blocked and quarantined clients are released.
- If you restart the Zyxel Device or restart an AP connected to the Zyxel Device, blocked and quarantined clients are still blocked until the block or quarantine period expires.

## 45.3 CDR Commands

The following describes the commands for CDR.

### 45.3.1 CDR General Commands

This table shows the commands for activating and configuring CDR..

Table 219 CDR General Commands

COMMAND	DESCRIPTION
[no] cdr activate	Enable CDR on the Zyxel Device. The <code>no</code> command disables CDR.
[no] cdr block block-wireless-client	Has traffic from the suspect client blocked at the AP. Use the <code>no</code> command to have traffic from the suspect client blocked at the Zyxel Device.
cdr block http-service-port <1..65535>	Changes the port number of the CDR HTTP blocking page.
cdr block https-service-port <1..65535>	Changes the port number of the CDR HTTPS blocking page.
cdr block message <i>denied_message</i>	Sets the message that is displayed on the default Zyxel Device notification page. The client is redirected here when a <b>Block</b> or <b>Quarantine</b> action is triggered. The message must be less than 127 characters.
cdr block period <0..1440>	Sets how long the client is blocked after a block action is triggered. 0 means the client is blocked forever. This should be at least twice the DHCP server lease time, in order to prevent false positives.
cdr block redirect <url>	Sets a URL in "http://domain" or "https://domain" format to an external notification page. The client is redirected here when a <b>Block</b> or <b>Quarantine</b> action is triggered. Make sure the external notification page is accessible from the Zyxel Device.
cdr block url { <i>message/redirect</i> }	Sets the notification web page that is displayed when a <b>Block</b> or <b>Quarantine</b> action is triggered. <ul style="list-style-type: none"> <li><b>message:</b> The Zyxel Device displays the default Zyxel Device notification page, with a message set by command <code>cdr block message</code>.</li> <li><b>redirect:</b> The Zyxel Device displays a custom external notification page, set by command <code>cdr block redirect</code>.</li> </ul>
cdr blocked-by { <i>ip/mac</i> }	Sets how CDR blocks suspected clients after a block or quarantine action is triggered. <ul style="list-style-type: none"> <li><b>IP:</b> The suspect client's IP address is blocked. However, the suspected client can access network resources again if it changes IP addresses, for example by picking up a new DHCP lease.</li> <li><b>MAC:</b> The suspect client's MAC address is blocked. However, the suspected client can access network resources again if it changes MAC address, for example by using a different source Ethernet port.</li> </ul> <p>Note: If you have a switch between the client and the Zyxel Device, then blocking by MAC address could block all traffic from the switch if the client MAC address is not forwarded through the switch.</p>

Table 219 CDR General Commands

COMMAND	DESCRIPTION
<code>cdr quarantine period</code> <code>&lt;0..1440&gt;</code>	Sets how long the client is quarantined after a quarantine action is triggered. 0 means the client is quarantined forever.
<code>cdr quarantine vlan-id</code> <code>&lt;1..4094&gt;</code>	Sets a previously configured VLAN as the quarantine VLAN. When a client is quarantined, the client's traffic is isolated and is broadcast only to members in the VLAN.
<code>cdr rule rule_id threshold</code> <code>occurrence duration duration</code> <code>action</code> <code>{alert block quarantine}</code>	Edits a CDR policy with the following values: <ul style="list-style-type: none"> <li>• <b>rule_id:</b> The category of the policy. At the time of writing, 1 = Malware, 2 = IDP, 3 = Web Threat.</li> <li>• <b>Occurrence:</b> The number of security events that need to occur within the defined <b>Duration</b> to trigger a CDR containment action. The valid range is 1 to 100.</li> <li>• <b>Duration:</b> The length of time, in minutes, that events needs to occur within the <b>Occurrence</b> number of times in order to trigger a CDR containment action. The valid range is 1 to 1440.</li> <li>• <b>Action:</b> The action to be taken when the number of security events exceed the threshold within the defined duration. <ul style="list-style-type: none"> <li>- <b>Alert:</b> Send an email to the suspect client owner or Zyxel Device admin.</li> <li>- <b>Block:</b> Block traffic from a suspect client at the Zyxel Device, or from a suspect WiFi client at the AP connected to the Zyxel Device. Traffic is still broadcast to other clients in the same subnet. A 'notification' web page is displayed when this action is triggered.</li> <li>- <b>Quarantine:</b> Select this if you want to isolate traffic from a suspect client at the Zyxel Device in a quarantine VLAN. Traffic is not broadcast to other clients in the same subnet. A 'notification' web page is displayed to the client when this action is triggered.</li> </ul> </li> </ul>
<code>cdr send-alerts-to</code> <code>email_address</code>	Sets an email address in the user@domain.com format of the owner of the suspect client or another person who should be informed that a CDR action was triggered.
<code>cdr unblock ipv4 ip_address</code>	Unblocks an IP address that is currently being blocked or quarantined. This removes the address from the CDR containment list.
<code>cdr unblock mac mac_address</code>	Unblocks an MAC address that is currently being blocked or quarantined. This removes the address from the CDR containment list.
<code>[no] cdr white-list ipv4</code> <code>ip_address</code>	Adds the IPv4 address to the exempt list. CDR will check traffic sent from the IP address and always flag it as PASS.  The <code>no</code> command removes the IP address from the whitelist.
<code>[no] cdr white-list mac</code> <code>mac_address</code>	Adds the MAC address to the exempt list. CDR will check traffic sent from the MAC address and always flag it as PASS.  The <code>no</code> command removes the MAC address from the whitelist.
<code>cdr white-list replace</code> <code>&lt;1..512&gt; ipv4 ip_address</code>	Replaces the numbered entry in the whitelist with the specified IPv4 address.
<code>cdr white-list replace</code> <code>&lt;1..512&gt; mac mac_address</code>	Replaces the numbered entry in the whitelist with the specified MAC address.

## 45.3.2 CDR Show Commands

This table shows the commands for showing CDR settings..

Table 220 CDR Show Activation

COMMAND	DESCRIPTION
<code>show cdr block-list</code>	Displays the CDR containment list. This list contains all devices currently being blocked or quarantined.
<code>show cdr event-list</code>	Displays the CDR event (history) list. This list contains up to 1024 devices that were previously blocked, quarantined, or triggered an alert.
<code>show cdr rules</code>	Displays all current CDR policies.
<code>show cdr signature</code>	Displays the version number and release date of the current CDR signatures.
<code>show cdr status</code>	Displays all CDR settings, such as block period, block message, and quarantine VLAN ID.
<code>show cdr update</code>	Displays the signature update schedule.
<code>show cdr white-list</code>	Displays all entries in the CDR exempt list. This consists of IPv4 and MAC addresses.

## 45.3.3 Update CDR Signatures

This table shows the commands for updating the CDR signatures..

Table 221 CDR Update Commands

COMMAND	DESCRIPTION
<code>cdr signature reload</code>	Recovers CDR signatures. You only need to do this if instructed by a support technician.
<code>cdr signature update</code>	Immediately downloads the latest CDR signatures.
<code>[no] cdr update auto</code>	Enables automatic CDR signature downloads, at the time and date set by the <code>daily/hourly/weekly</code> command.  Use the <code>no</code> command to disable auto updates.
<code>cdr update daily &lt;0..23&gt;</code>	Enables automatic CDR signature downloads every day at the time specified.
<code>cdr update hourly</code>	Enables automatic CDR signature download every hour.
<code>cdr update weekly {sun   mon   tue   wed   thu   fri   sat} &lt;0..23&gt;</code>	Enables automatic CDR signature downloads once a week at the time and day specified.

### 45.3.3.1 Update Signature Examples

This examples shows how to enable automatic CDR signature updates daily at midnight, and then check that it is configured corrected.

```
Router(config)# configure terminal
Router(config)# cdr update auto
Router(config)# cdr update daily 0
Router(config)# show cdr update
auto: yes
schedule: daily at 0 o'clock
```

# CHAPTER 46

## SSL Inspection

This chapter describes how to set up SSL Inspection for the Zyxel Device.

### 46.1 SSL Inspection Overview

Secure Socket Layer (SSL) traffic, such as HTTPS, FTPS, POP3+SSL, and SMTPS, is encrypted and therefore cannot be inspected using Unified Threat Management (UTM) profiles such as App Patrol, Content Filter, Intrusion, Detection and Prevention (IDP), or Anti-Virus. The Zyxel Device uses SSL Inspection to decrypt SSL traffic, sends it to the UTM engines for inspection, then encrypts traffic that passes inspection and forwards it to the destination server, such as Google.

The Zyxel Device supports the following SSL/TLS versions and cipher suites:

- SSLv3 AES-CBC
- TLS1.0 AES-CBC
- TLS1.2 AES-CBC/AES-GCM
- TLS1.3 AES-GCM

SSL Inspection does not support the following:

- Compression
- Client Authentication
- TLS1.3 Key updates - )
- TLS1.3 Zero Round Trip Time Resumption (0-RTT)

### 46.2 SSL Inspection Commands Summary

The following table describes the values required for many SSL inspection commands. Other values are discussed with the corresponding commands.

Table 222 Input Values for SSL Inspection Commands

LABEL	DESCRIPTION
<i>ssi_profile_name</i>	This is the name of the profile. You may use 1-31 alphanumeric characters, underscores(_), or dashes (-), but the first character cannot be a number. This value is case-sensitive.
<i>description</i>	This is additional information about this SSL Inspection profile. You can enter up to 60 characters ("0-9", "a-z", "A-Z", "-" and "_").
<i>cert_name</i>	This is a name of a certificate.

The following sections list the commands.



## 46.2.1 SSL Inspection General Settings

Table 223 SSL Inspection General Settings

COMMAND	DESCRIPTION
<code>ssl-inspection server-sign-cert mode {default   rsa-1024   rsa-2048}</code>	<p>Select how to validate a client accessing a HTTPS website using RSA encryption through the Zyxel Device. The Zyxel Device must check that the client's certificate and public key are valid and were issued by a Certificate Authority (CA) listed in the Zyxel Device's list of trusted CAs. The default value is 1024.</p> <p>Note: You should flush the SSL inspection certificate cache after changing the server signing mode.</p>
<code>ssl-inspection server-sign-cert mode {ecdsa-rsa-1024 ecdsa-rsa-2048}</code>	<p>Select how to validate a client accessing a HTTPS website using ECDSA encryption through the Zyxel Device. ECDSA is required by certain clients such as iOS 13.</p> <ul style="list-style-type: none"> <li><code>ecdsa-rsa-1024</code> means the Zyxel Device uses ECDSA-256 if the client supports ECDSA-256, or RSA-1024 if the client does not support ECDSA-256.</li> <li><code>ecdsa-rsa-2048</code> means the Zyxel Device uses ECDSA-256 if the client supports ECDSA-256, or RSA-2048 if the client does not support ECDSA-256.</li> </ul>
<code>ssl-inspection pkt-enc-mss &lt;536..1460&gt;</code>	<p>Sets the maximum TCP packet size that the Zyxel Device will encrypt, in bytes. If a packet's size is greater than this value, then the Zyxel Device splits the packet into two or more packets.</p> <p>The default value is 1460.</p>
<code>show ssl-inspection status</code>	Displays the current configuration of SSL inspection.

## 46.2.2 SSL Inspection Exclusion Commands

There may be privacy and legality issues regarding inspecting a user's encrypted session. The legal issues may vary by locale, so it's important to check with your legal department to make sure that it's OK to intercept SSL traffic from your Zyxel Device users.

To ensure individual privacy and meet legal requirements, you can configure an exclusion list to exclude matching sessions to destination servers. This traffic is not intercepted and passes through the Zyxel Device uninspected.

This table lists the SSL Inspection exclusion-related commands.

Table 224 SSL Inspection Exclusion Commands

COMMAND	DESCRIPTION
<code>ssl-inspection exclude-list</code>	Enter SSL Inspection exclude list sub-command mode.  In this mode you can add and remove the servers that are excluded from SSL Inspection.
<code>[no] entry {IPv4   IPv4_CIDR   IPv4_RANGE   IPv6   IPv6_PREFIX   IPv6_RANGE   SSL_INSPECTION_WILDCARD_CNAME}</code>	Identify the certificate in one of the following ways: <ul style="list-style-type: none"> <li>Type an IPv4 or IPv6 address. For example, type 192.168.1.35, or 2001:7300:3500::1</li> <li>Type an IPv4/IPv6 block in CIDR notation. For example, type 192.168.1.1/24, or 2001:7300:3500::1/64</li> <li>Type an IPv4/IPv6 address range by entering the start and end addresses separated by a hyphen (-). For example, type 192.168.1.1-192.168.1.35, or 2001:7300:3500::1-2001:7300:3500::35</li> <li>Type a DNS name. For example, type www.zyxel.com.tw.</li> <li>Type a common name (wildcard char: '*', escape char: '\'). Use up to 127 case-insensitive characters (0-9a-zA-Z`-!@#\$\$%^&amp;*()-_+=[]\   ;',.&lt;&gt;/?). '*' can be used as a wildcard to match any string. Use '\*' to indicate a single wildcard character.</li> <li>Type an email address. For example, type abc@zyxel.com.tw</li> </ul> The <code>no</code> command removes the SSL entry.
<code>exit</code>	Exit the sub-command mode.
<code>show ssl-inspection exclude-list</code>	Displays all entries in the SSL exclusion list.
<code>ssl-inspection exclude-list-settings</code>	Enter SSL Inspection exclude list settings sub-command mode.  In this mode you can configure settings for the SSL Inspection exclude list.
<code>[no] log</code>	Create a log for traffic that bypasses SSL Inspection.  The <code>no</code> command disables SSL exclusion list logging.
<code>exit</code>	Exit the sub-command mode.
<code>show ssl-inspection exclude-list settings</code>	Displays all SSL exclusion list settings, such as whether logging is enabled.

### 46.2.3 SSL Inspection Profile Settings

This table lists the SSL Inspection profile setting commands.

Table 225 SSL Inspection Profile Commands

COMMAND	DESCRIPTION
<code>ssl-inspection profile ssi_profile_name</code>	Creates an SSL Inspection profile, and then enters the SSL Inspection profile sub-command mode.  The profile name may consist of 1-31 alphanumeric characters, underscores(_), or dashes (-), but the first character cannot be a number. This value is case-sensitive.
<code>bind-ipv4-addr ipv4</code>	Request a certificate using the specified IPv4 source address. This command is for debugging purposes.
<code>bind-ipv6-addr ipv6</code>	Request a certificate using the specified IPv6 source address. This command is for debugging purposes.
<code>[no] certificate cert_name</code>	Enter the default certificate or one already created for this profile.  The <code>no</code> command removes the certificate from this profile.

Table 225 SSL Inspection Profile Commands

COMMAND	DESCRIPTION
[no] description description	Enter additional information about this SSL Inspection entry. You can enter up to 60 characters ("0-9", "a-z", "A-Z", "-" and "_").  The no command removes the description.
exit	Exit sub-command mode.
follow-real-client-routing {yes   no}	When an SSL session is detected by SSL inspection, the Zyxel Device creates another independent session in order to get information such as the certificate chain. However, because traffic for this new session is sent from the Zyxel Device, it may not match the same routing policy of the original SSL session and may not reach the destination server.  Enable this command to allow the session sent from the Zyxel Device to follow the routing policy of the original session. The no command does not allow the session sent from the Zyxel Device to follow the routing policy of the original session.
sslv2 action {pass   block} {no log   log [alert]}	SSL Inspection supports SSLv3 and TLS1.0. This command sets the action and log event for when the Zyxel Device encounters SSLv2 traffic.  <ul style="list-style-type: none"> <li>Pass: SSLv2 traffic is allowed to pass through the Zyxel Device uninspected.</li> <li>Block: SSLv2 traffic is blocked.</li> </ul> You can also set the logging events.  <ul style="list-style-type: none"> <li>no log: Do not log SSLv2 traffic events.</li> <li>log: Create a log message when SSLv2 traffic is passed through or blocked.</li> <li>log: Create a log message and issue an alert email when SSLv2 traffic is passed through or blocked.</li> </ul>
support-version-max {ssl3   tls1_0   tls1_1   tls1_2   tls1_3}	The Zyxel Device only inspects SSL traffic if the SSL version is equal to this value or lower.
support-version-min {ssl3   tls1_0   tls1_1   tls1_2   tls1_3}	The Zyxel Device only inspects SSL traffic if the SSL version is equal to this value or higher.
unsupported-suite action {pass   block} {no log   log [alert]}	Select to <b>pass</b> or <b>block</b> unsupported traffic, such as traffic using unsupported cipher suites, compression, or client authentication.
untrusted-cert-chain action {block   inspect   pass} {no log   log [alert]}	A certificate chain is a certification process that involves the following certificates between the SSL/TLS server and a client. A certificate chain will fail if one of the following certificates is not correct.  <ul style="list-style-type: none"> <li>A certificate owned by a user</li> <li>The certificate signed by a certification authority</li> <li>A root certificate</li> </ul> Select to <b>pass</b> , <b>inspect</b> , or <b>block</b> an untrusted certification chain.
ssl-inspection profile rename ssi_profile_name1 ssi_profile_name2	Renames an SSL Inspection profile.
no ssl-inspection profile ssi_profile_name	Deletes an SSL Inspection profile.

Table 225 SSL Inspection Profile Commands

COMMAND	DESCRIPTION
<code>show ssl-inspection profile [ssi_profile_name]</code>	Displays SSL Inspection profile settings.
<code>ssl-inspection tls1-3 {activate   deactivate}</code>	Enables or disables support for TLS 1.3 on the Zyxel Device.
<code>ssl-inspection tls1-2 aescm {activate   deactivate}</code>	Enables or disables support for cipher TLS 1.2 AES-GCM on the Zyxel Device.

## 46.2.4 SSL Inspection Certificate Cache

This table lists the SSL Inspection certificate cache commands.

Table 226 SSL Inspection Certificate Cache Commands

COMMAND	DESCRIPTION
<code>ssl-inspection cache flush</code>	Clears SSL Inspection cached entries.
<code>show ssl-inspection cert-list</code>	Displays certificates used in SSL Inspection.

## 46.2.5 SSL Inspection Certificate Update

Use these commands to update the latest certificates of servers using SSL connections to the Zyxel Device network. You must have Internet access and have activated SSL Inspection on the Zyxel Device at myZyxel.com.

This table lists the SSL Inspection certificate cache commands.

Table 227 SSL Inspection Certificate Update Commands

COMMAND	DESCRIPTION
<code>[no] ssl-inspection cert-update auto</code>	The Zyxel Device automatically updates the certificate set when a new one becomes available on myZyxel.com.
<code>ssl-inspection cert-update now</code>	Download the latest certificate set from the myZyxel.com and update it on the Zyxel Device.
<code>show ssl-inspection default-cert version</code>	Displays the default certificate update status.
<code>show ssl-inspection default-cert update</code>	Shows the current certificate update status.
<code>show ssl-inspection cert-update status</code>	Shows if automatically updating the certificate set is configured on the Zyxel Device.

These are some example SSL Inspection certificate update usage commands.

```
Router(config)# show ssl-inspection cert-update status
update auto      : no
Router(config)# ssl-inspection cert-update auto
Router(config)# show ssl-inspection cert-update status
update auto      : yes
Router(config)# show ssl-inspection default-cert update
/tmp/sslinsp_certs/default_trusted /
current status: Connecting to update server to get SSL certificate. at Fri Apr 10
03:47:37 2015

Router(config)# show ssl-inspection default-cert update
current status: SSL Certificate update has succeeded. (success) at Fri Apr 10
03:47:49 2015
Router(config)#
```

## 46.2.6 SSL Inspection Statistics

This table lists the SSL Inspection statistics commands.

Table 228 SSL Inspection Statistics Commands

COMMAND	DESCRIPTION
[no] ssl-inspection statistics collect	Enables SSL inspection statistics collection. The no command disables SSL exclusion statistics collection.
ssl-inspection statistics flush	Clears SSL inspection statistics.
show ssl-inspection statistics collect	Shows if SSL inspection statistics collection is enabled.
show ssl-inspection statistics summary	Shows SSL inspection statistics such as concurrent sessions, total ssl sessions, sessions inspected, decrypted Kbytes, encrypted Kbytes, sessions blocked, and sessions passed.

## 46.2.7 SSL Inspection Command Examples

These are some other example SSL Inspection usage commands.

```
Router(config)#Router(config)# ssl-inspection exclude-list-settings
Router(ssl-inspection-exclude-list-settings)# no log
Router(ssl-inspection-exclude-list-settings)# exit
Router(config)# ssl-inspection exclude-list
Router(ssl-inspection-exclude-list)# entry 1.1.1.1
Router(ssl-inspection-exclude-list)# entry abc@zyxel.com.tw
Router(ssl-inspection-exclude-list)# exit
Router(config)# show ssl-inspection exclude-list settings
SSL Inspection Exclude List Global Information
  Log: no
Router(config)# show ssl-inspection exclude-list
No.  Exclude list of Certificate Identity
=====
0    1.1.1.1
1    abc@zyxel.com.tw
Router(config)# ssl-inspection profile dummy
Router(config-ssl-inspection-profile-dummy)# description this is a dummy profile
Router(config-ssl-inspection-profile-dummy)# certificate default
Router(config-ssl-inspection-profile-dummy)# sslv2 action block log
Router(config-ssl-inspection-profile-dummy)# unsupported-suite action block log
Router(config-ssl-inspection-profile-dummy)# untrusted-cert-chain action block log
Router(config-ssl-inspection-profile-dummy)# exit
Router(config)# show ssl-inspection profile dummy
SSL-Inspection: 3
  profile name: dummy
  description: this is a dummy profile
  Certificate: default
  Follow_real_client_routing: yes
  SSLv2_action: block
  SSLv2_log: log
  Unsupported_suite_action: block
  Unsupported_suite_log: log
  Untrusted_cert_chain_action: block
  Untrusted_cert_chain_action_log: log
  Reference: 0
Router(config)# ssl-inspection statistics collect
Router(config)# show ssl-inspection statistics collect
collect statistics: yes
collect statistics time: since 2014-06-20 05:47:37 to 2014-06-20 05:47:55
Router(config)# show ssl-inspection statistics summary
maximum concurrent sessions   : 1000
concurrent sessions           : 0

total ssl sessions             : 0
  sessions inspected           : 0
    decrypted Kbytes           : 0
    encrypted Kbytes           : 0
  sessions blocked             : 0
  sessions passed              : 0

Router(config)#
```

# CHAPTER 47

## IP Exception

### 47.1 IP Exception Overview

IP Exception allows incoming IP packets to bypass specific security services based on the packet's source or destination address. Bypassing a security service means the security service does not intercept or inspect the packet. IP Exception supports bypassing the following security services:

- Antivirus (including sandboxing)
- Intrusion Detection and Prevention (IDP)
- IP Reputation
- URL Threat Filter

### 47.2 IP Exception Commands

The Zyxel Device excludes incoming packets that match any IP Exception rule. Each IP Exception rule contains a source address, destination address, and a list of bypassed services. The following table identifies the values required for many IP Exception commands..

Table 229 General Input Values for IP Exception List Commands

LABEL	DESCRIPTION
<i>&lt;profile-name&gt;</i>	The name of an IP Exception rule. You may use 1-31 alphanumeric characters, underscores(_), or dashes (-), but the first character cannot be a number. This value is case-sensitive.
<i>address_name</i>	The source or destination address of an IP packet. The address name can be any of the following: <ul style="list-style-type: none"><li>• Address object name</li><li>• Address group object name</li><li>• FQDN object name</li><li>• Geo IP object name</li></ul> For details on addresses, see <a href="#">Chapter 52 on page 444</a> .

Table 230 Commands for IP Exception

COMMAND	DESCRIPTION
<code>security-service ip-exception {profile_name}</code>	Configure an IPv4 rule. If the rule does not currently exist, then the Zyxel Device creates it.
<code>source {address_name   any} destination {address_name   any} {log   no-log}</code>	<i>address_name</i> : Apply this rule to IPv4 packets with the specified source or destination address. <i>any</i> : Apply this rule to IPv4 packets with any source or destination address. <i>log</i> : Create a log message each time an incoming IPv4 packet matches this rule. <i>no-log</i> : Do not create any log messages.
<code>[no] {anti-virus   ip-reputation   ips   threat-website} bypass</code>	Sets the service that IPv4 packets will bypass. To bypass multiple services, run the command multiple times. <i>ips</i> is IDP. Use the <i>no</i> command to stop bypassing a service.
<code>[no] description {DESCRIPTION}</code>	{ <i>DESCRIPTION</i> }: Sets a description for the IP Exception rule. You can use up to 60 printable ASCII characters. Use the <i>no</i> command to delete the description for this profile.
<code>security-service ip6-exception {profile_name}</code>	Configure an IPv6 rule. If the rule does not currently exist, then the Zyxel Device creates it.
<code>source {address_name   any} destination {address_name   any} {log   no-log}</code>	<i>address_name</i> : Apply this rule to IPv6 packets with the specified source or destination address. <i>any</i> : Apply this rule to IPv6 packets with any source or destination address. <i>log</i> : Create a log a log message each time an incoming IPv6 packet matches this rule. <i>no-log</i> : Do not create any log messages.
<code>[no] {anti-virus   ip-reputation   ips   threat-website} bypass</code>	Sets a service that IPv6 packets will bypass. You can run this command multiple times to bypass multiple services. <i>ips</i> is IDP. Use the <i>no</i> command to stop bypassing a service.
<code>[no] description {DESCRIPTION}</code>	{ <i>DESCRIPTION</i> }: Sets a description for the IP Exception rule. You can use up to 60 printable ASCII characters. Use the <i>no</i> command to delete the description for this profile.
<code>no security-service ip-exception profile_name</code>	Removes the specified IPv4 rule.
<code>no security-service ip6-exception profile_name</code>	Removes the specified IPv6 rule.
<code>show security-service ip-exception</code>	Displays all IPv4 rules.
<code>show security-service ip6-exception</code>	Displays all IPv6 rules.



# CHAPTER 48

## Device HA

Use device HA to increase network reliability. Device HA lets a backup Zyxel Device (B) automatically take over if a master Zyxel Device (A) fails.

**Figure 35** Device HA Backup Taking Over for the Master

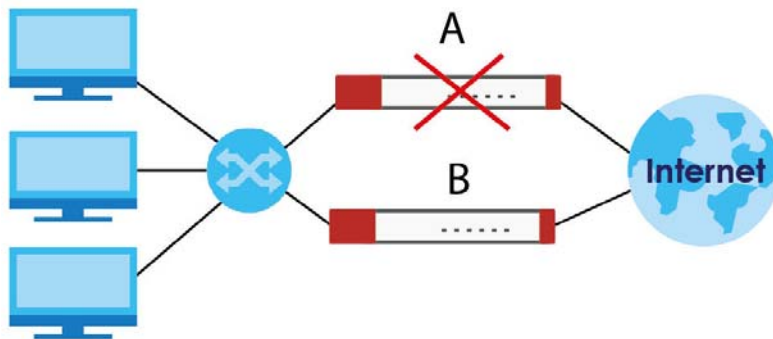

## 48.1 Device HA Overview

### Active-Passive Mode

- Active-passive mode lets a backup Zyxel Device take over if the master Zyxel Device fails.
- The Zyxel Devices must all support and be set to use the same device HA mode (either active-passive or legacy).

### Management Access

You can configure a separate management IP address for each interface. You can use it to access the Zyxel Device for management whether the Zyxel Device is the master or a backup. The management IP address should be in the same subnet as the interface IP address.

### Synchronization

Use synchronization to have a backup Zyxel Device copy the master Zyxel Device's configuration, signatures (anti-virus, IDP/application patrol, and system protect), and certificates.

Note: Only Zyxel Devices of the same model and firmware version can synchronize.

Otherwise you must manually configure the master Zyxel Device's settings on the backup (by editing copies of the configuration files in a text editor for example).

## 48.1.1 Before You Begin

- Configure a static IP address for each interface that you will have device HA monitor.

Note: Subscribe to services on the backup Zyxel Device before synchronizing it with the master Zyxel Device.

- Synchronization includes updates for services to which the master and backup Zyxel Devices are both subscribed. For example, a backup subscribed to IDP/AppPatrol, but not anti-virus, gets IDP/AppPatrol updates from the master, but not anti-virus updates. It is highly recommended to subscribe the master and backup Zyxel Devices to the same services.

## 48.1.2 Device HA and Device HA Pro

Refer to the Introduction chapter of the ZyWALL USG Series User's Guide for a list of device models that support Device HA Pro.

The following table shows some differences between Device HA and Device HA Pro.

Table 231 Device HA Vs Device HA Pro

FEATURE	DEVICE HA	DEVICE HA PRO
Role	Role of Master and Backup is configurable. Master takes over from Backup if the Master goes down and then becomes the Master again if it comes back online again (failback).	Role of active and passive is not configurable. The active model is the one whose heartbeat interface comes online first. passive becomes active if active goes down and stays active even if the previous active comes online again.
Firmware Upgrade	Master remains Master by default when new firmware is uploaded.	New firmware is first uploaded to the passive device and then uploaded to the active device. By default, the passive device reboots after firmware upload making it become the active device. Clear the Reboot prompt in the Web Configurator after uploading firmware to the passive device if you want the passive device to remain passive when new firmware is uploaded.
What is synchronized	Configuration file	Configuration file, device time, IPv4/v6 TCP sessions, IPSec VPN tunnels, user login/logout information, AV/IDP signatures, DHCP table, IP/MAC binding table.
Maximum Failover Count	0	5 (default) to 50. Can be reset by command.
Best case Failover delay	10-30 seconds to rebuild connections.	0-1 seconds.
Monitored Interfaces	Ethernet	Ethernet, VLAN, Bridge, LAG
Dedicated monitor port	No	Heartbeat interface.  Note: Remove Ethernet, VLAN, Bridge, LAG configurations from this port first.

## 48.2 General Device HA Commands

This table lists the general commands for device HA.

Table 232 device-ha General Commands

COMMAND	DESCRIPTION
<code>show device-ha status</code>	Displays whether or not device HA is activated, the configured device HA mode, and the status of the monitored interfaces.
<code>[no] device-ha activate</code>	Turns device HA on or off.
<code>device-ha mode active-passive</code>	Sets the Zyxel Device to use active-passive device HA.

## 48.3 Active-Passive Mode Device HA

### Virtual Router

The master and backup Zyxel Device form a single 'virtual router'.

### Cluster ID

You can have multiple Zyxel Device virtual routers on your network. Use a different cluster ID to identify each virtual router.

### Monitored Interfaces in Active-Passive Mode Device HA

You can select which interfaces device HA monitors. If a monitored interface on the Zyxel Device loses its connection, device HA has the backup Zyxel Device take over.

Enable monitoring for the same interfaces on the master and backup Zyxel Devices. Each monitored interface must have a static IP address and be connected to the same subnet as the corresponding interface on the backup or master Zyxel Device.

### Virtual Router and Management IP Addresses

- If a backup takes over for the master, it uses the master's IP addresses. These IP addresses are known as the virtual router IP addresses.
- Each interface can also have a management IP address. You can connect to this IP address to manage the Zyxel Device regardless of whether it is the master or the backup.

## 48.4 Active-Passive Mode Device HA Commands

The following table identifies the values required for many of these commands. Other input values are discussed with the corresponding commands.

Table 233 Input Values for device-ha Commands

LABEL	DESCRIPTION
<i>interface_name</i>	<p>The name of the interface. This depends on the Zyxel Device model.</p> <p>For some Zyxel Device models, use <i>gex</i>, <math>x = 1 \sim N</math>, where <math>N</math> equals the highest numbered Ethernet interface for your Zyxel Device model.</p> <p>For other Zyxel Device models, use a name such as <i>wan1</i>, <i>wan2</i>, <i>opt</i>, <i>lan1</i>, or <i>dmz</i>.</p> <p>Besides, in HA AP mode, the interface can also be a bridge interface.</p> <p>In HA Legacy mode, the interface can also be a VLAN interface.</p>

The following sections list the *device-ha* commands.

### 48.4.1 Active-Passive Mode Device HA Commands

This table lists the commands for configuring active-passive mode device HA.

Table 234 device-ha ap-mode Commands

COMMAND	DESCRIPTION
[no] <i>device-ha ap-mode preempt</i>	Turn on preempt if this Zyxel Device should become the master Zyxel Device if a lower-priority Zyxel Device is the master when this Zyxel Device is enabled.
<i>device-ha ap-mode role</i> { <i>master backup</i> }	Sets the Zyxel Device to be the master or a backup in the virtual router.
<i>device-ha ap-mode cluster-id</i> <1..32>	Sets the cluster ID number. A virtual router consists of a master Zyxel Device and all of its backup Zyxel Devices. If you have multiple Zyxel Device virtual routers on your network, use a different cluster ID for each virtual router.
<i>device-ha ap-mode priority</i> <1..254>	Sets backup Zyxel Device's priority. The backup Zyxel Device with the highest value takes over the role of the master Zyxel Device if the master Zyxel Device becomes unavailable. The priority must be between 1 and 254. (The master interface has priority 255.)
[no] <i>device-ha ap-mode authentication</i> { <i>string key</i>   <i>ah-md5 key</i> }	<p>Sets the authentication method the virtual router uses. Every interface in a virtual router must use the same authentication method and password. The no command disables authentication.</p> <p><i>string</i>: Use a plain text password for authentication. <i>key</i> - Use up to eight characters including alphanumeric characters, the underscore, and some punctuation marks (+-/*= ; : ! @\$&amp;%#~ ' \ ( ) ).</p> <p><i>ah-md5</i>: Use an encrypted MD5 password for authentication. <i>key</i> - Use up to eight characters including alphanumeric characters, the underscore, and some punctuation marks (+-/*= ; : ! @\$&amp;%#~ ' \ ( ) ).</p>
[no] <i>device-ha ap-mode interface_name manage-ip ip subnet_mask</i>	Sets the management IP address for an interface.
[no] <i>device-ha ap-mode interface_name activate</i>	Has device HA monitor the status of an interface's connection.

Table 234 device-ha ap-mode Commands (continued)

COMMAND	DESCRIPTION
[no] device-ha ap-mode master sync authentication password <i>password</i>	This is for a master Zyxel Device. It specifies the password to require from synchronizing backup Zyxel Devices. Every router in the virtual router must use the same password. The <b>no</b> command sets the password setting to blank (which means no backups can synchronize with this master).  <i>password</i> : Use 4-63 alphanumeric characters, underscores (_), dashes (-), and #%^*={ } : , . ~ characters.
[no] device-ha ap-mode backup sync authentication password <i>password</i>	Sets the password the backup Zyxel Device uses when synchronizing with the master. The <b>no</b> command sets the password setting to blank (which means this backup Zyxel Device cannot synchronize with the master).  <i>password</i> : Use 4-63 alphanumeric characters, underscores (_), dashes (-), and #%^*={ } : , . ~ characters.
[no] device-ha ap-mode backup sync auto	Turns on automatic synchronization according to the interval you specify in device-ha ap-mode backup sync interval. The first synchronization begins after the specified interval (not immediately).
[no] device-ha ap-mode backup sync interval <5..1440>	When you use automatic synchronization, this sets how often (in minutes) the Zyxel Device synchronizes with the master.
[no] device-ha ap-mode backup sync from <i>master_address</i> port <i>port</i>	Sets the address of the master Zyxel Device with which this backup Zyxel Device is to synchronize.  <i>master_address</i> : The master Zyxel Device's IP address or fully-qualified domain name (FQDN).  <i>port</i> : The master Zyxel Device's FTP port number.
device-ha ap-mode backup sync now	Synchronize now.
show device-ha ap-mode interfaces	Displays the device HA AP mode interface settings and status.
show device-ha ap-mode next-sync-time	Displays the next time and date (in hh:mm yyyy-mm-dd format) the Zyxel Device will synchronize with the master.
show device-ha ap-mode status	Displays the Zyxel Device's key device HA settings.
show device-ha ap-mode master sync	Displays the master Zyxel Device's synchronization settings.
show device-ha ap-mode backup sync	Displays the backup Zyxel Device's synchronization settings.
show device-ha ap-mode backup sync status	Displays the backup Zyxel Device's current synchronization status.
show device-ha ap-mode backup sync summary	Displays the backup Zyxel Device's synchronization settings.
show device-ha ap-mode forwarding-port <i>interface_name</i>	If you apply Device HA on a bridge interface on a backup Zyxel Device, you can use this command to see which port in the bridge interface is chosen to receive VRRP packets used to monitor if the master Zyxel Device goes down.  <i>interface_name</i> : This is a bridge interface, For example, brx.
show device-ha mode	Displays whether this Zyxel Device is in active-passive mode.

## 48.4.2 Active-Passive Mode Device HA Command Example

This example configures a Zyxel Device to be a master Zyxel Device for active-passive mode device HA. There is a management IP address of 192.168.1.3 on lan1. wan1 and lan1 are monitored. The synchronization password is set to "mySyncPassword".

```
Router(config)# device-ha ap-mode lan1 manage-ip 192.168.1.3 255.255.255.0
Router(config)# device-ha ap-mode role master
Router(config)# device-ha ap-mode master sync authentication password
mySyncPassword
Router(config)# device-ha ap-mode wan1 activate
Router(config)# device-ha ap-mode lan1 activate
Router(config)# device-ha activate
```

## 48.5 Device HA Pro

You need a license to use Device HA Pro. Device HA Pro is easier to deploy than Device HA, is more reliable (no risk of overloading), and faster (Device HA causes a connection break of 10-30 seconds while Device HA Pro just has 1-2 seconds). In addition to configuration file backup in Device HA, device time, TCP sessions (IPv4/IPv6), IPsec VPN sessions, login/logout information and license status can also be backed up using Device HA Pro.

### Active and Passive Devices

Device HA Pro uses a dedicated heartbeat link between an active device and a passive device for dynamic syncing and backup to the passive device. On the passive device, all ports are disabled except for the port with the heartbeat link.

Note: The dedicated heartbeat link port must be the highest-numbered port on each Zyxel Device for Device HA Pro to work.

Failover from the active Zyxel Device to the passive Zyxel Device is activated when:

- A monitored interface is down
- A monitored service (daemon) is down
- The heartbeat link exceeds the failure tolerance.

After failover, the initial active Zyxel Device becomes the passive Zyxel Device after it recovers.

See [Section 48.1.2 on page 418](#) for differences between Device HA and Device HA Pro.

### 48.5.1 Deploying Device HA Pro

- 1 Register either the active or passive Zyxel Device with a Device HA Pro license at MyZyxel.com. Check that it's properly licensed in **Licensing > Registration > Service** in the active Zyxel Device.
- 2 Make sure the passive Zyxel Device is offline, then enable Device HA in **Device HA > General** in the passive Zyxel Device.

- 3 Must make sure the FTP port in **System > FTP** (default 21) is the same on both Zyxel Devices. FTP is used for transferring files in the event of failover from active to passive Zyxel Device.
- 4 Connect the passive Zyxel Device to the active Zyxel Device using the highest-numbered ports on both Zyxel Devices.

Note: If both Zyxel Devices are turned on at the same time with Device HA enabled, then they may send the heartbeat at the same time. In this case, the Zyxel Device with the bigger MAC address becomes the passive Zyxel Device.

- 5 When using Device HA Pro to synchronize firmware, the location of the running firmware must be the same in both active and passive Zyxel Devices. For example, if the running firmware is in partition 1 in the active Zyxel Device (standby firmware in partition 2), then the running firmware must also be in partition 1 in the passive Zyxel Device (standby firmware in partition 2).
- 6 When using Device HA Pro to update new firmware, the new firmware is downloaded to the active device. The active device sends a ping to the passive device to see if it is alive. If the active device receives a reply from the passive device, it uploads the new firmware to the passive device. The passive device uploads the new firmware and then reboots. The active device then repeatedly pings the passive device again as it reboots. The active device waits from 1-3,600 seconds `check-timeout` (with 1,800 as the default) for a reply from the passive device indicating it has fully rebooted. If the active device does not receive a reply within the check-timeout, it will not update its own firmware. If it receives a reply, the active device again waits from 1-300 seconds `delay` (with 10 as the default) before updating its own firmware. The passive device becomes the active device after a successful reboot with the new firmware.

## 48.5.2 Device HA Pro Commands

This table lists the commands for Device HA Pro (`device-ha2`).

Table 235 `device-ha2` (Device HA Pro) Commands

COMMAND	DESCRIPTION
<code>[no] device-ha2 activate</code>	Turns Device HA Pro on or off ( <code>no</code> ).
<code>[no] device-ha2 interface_name activate</code>	Turns Device HA Pro monitoring on or off ( <code>no</code> ) on the specified interface.
<code>[no] device-ha2 manage-ip ip1 ip2 subnet_mask</code>	Sets or removes ( <code>no</code> ) the IPv4 address and subnet mask of the heartbeat dedicated link port (the highest-numbered port) on the active and passive Zyxel Device.  <i>ip1</i> : IPv4 address of the active Zyxel Device. <i>ip2</i> : IPv4 address of the passive Zyxel Device.
<code>device-ha2 sync password password</code>	Sets a synchronization password of between 1 and 32 single-byte printable characters.
<code>[no] device-ha2 sync password</code>	Enables or disables ( <code>no</code> ) being prompted for the password before synchronization takes place.
<code>device-ha2 sync_to_passive</code>	Manually synchronizes the passive and active devices. Use this command on the active device. This command is available in User or Privilege mode.
<code>device-ha2 sync_from_active</code>	Manually synchronizes the passive and active devices. Use this command on the passive device. This command is available in User or Privilege mode.
<code>[no] device-ha2 disable-session-sync</code>	Disables or enables ( <code>no</code> ) connection tracking session synchronization.

Table 235 device-ha2 (Device HA Pro) Commands (continued)

COMMAND	DESCRIPTION
[no] device-ha2 srv-monitor	Enables or disables (no) service monitoring. When enabled, the passive Zyxel Device takes over when a monitored service daemon on the active Zyxel Device fails.
[no] device-ha2 connchk-monitor	Enables or disables (no) connection check monitoring. When enabled, the passive Zyxel Device takes over when a monitored interface on the active Zyxel Device fails.
device-ha2 failover connchk-hold-time <60..86400>	Sets a minimum time period between failovers to mitigate failover flapping. Failover flapping occurs when the active and passive devices keep switching due for example to a faulty up-link connection.
device-ha2 heartbeat period <1..10> fail-tolerance <1..10>	Sets when failover is activated on the passive Zyxel Device. Zyxel Device will change to active mode if it doesn't receive a heartbeat after heartbeat period x fail-tolerance seconds.  heartbeat period: the number of seconds (1-10) allowed for absence of a heartbeat signal.  fail-tolerance: the number of heartbeat failures allowed.
device-ha2 license-sync serial_number	Sets the serial number of the Zyxel Device (active or passive) with the Device HA Pro subscribed license.
device-ha2 virtual-mac zynos_style_mac_address	Specifies the Virtual MAC address of a port on the active Zyxel Device. Virtual MAC is a shared MAC address which is owned by the active Zyxel Device. All traffic can communicate with this shared MAC address, allowing the backup Zyxel Device to pick up traffic seamlessly.  zynos_style_mac_address: The first (wan0) MAC address of the Zyxel Device. A Zyxel-style MAC address must use the Zyxel OUI (Organizationally Unique Identifier) such as <b>00-13-49-XX-XX-XX</b> .
device-ha2 failover-count <5 ..50>	Sets the maximum number of times a Zyxel Device can change from active to passive mode. The Zyxel Device won't change to passive mode if it's already changed to passive mode failover-count times. This is to prevent too many changes between active and passive mode.
device-ha2 failover reset-interval <1..30>	Sets the time period after which the failover counter can be reset (1-30 days). The default is 5 days. For example, if the failover-count is 5 and the failover reset-interval is 30, then Zyxel Device can change from active to passive mode at most 5 times within 30 days.
device-ha2 ap-firmware-sync	Sets the active device to upload the latest AP firmware to the passive device after the active device discovers and downloads the latest AP firmware from the cloud server.
device-ha2 firmware-update check-timeout	Sets how long the active device will wait for a reply ping from the passive device indicating it has fully rebooted.  check-timeout: 1 - 3,600 seconds with 1,800 as the current default
device-ha2 firmware-update delay	Sets how long the active device will wait before updating its firmware after receiving a reply ping from the passive device.  delay time: 1 - 300 seconds with 10 as the current default
show device-ha2 activation	Displays whether or not Device HA Pro is activated.
show device-ha2 mode	Displays whether this Zyxel Device is the active or passive device.  HA mode: Active   Passive.
show device-ha2 device-status	Displays if this Zyxel Device is active or passive, heartbeat link status, this Zyxel Device serial number, Virtual MAC address and synchronization progress.
show device-ha2 passive device-status	Displays the passive Zyxel Device heartbeat link status, the passive Zyxel Device serial number, Virtual MAC address and synchronization progress.



Table 235 device-ha2 (Device HA Pro) Commands (continued)

COMMAND	DESCRIPTION
show device-ha2 passive log	Displays High Availability logs for the passive Zyxel Device.
show device-ha2 interfaces	Displays Device HA Pro monitored interfaces.
show device-ha2 log	Displays Device HA Pro logs.
show device-ha2 trace-log	Displays the active device's Device HA Pro trace logs.
show device-ha2 passive trace-log	Displays the passive device's Device HA Pro trace logs.
show device-ha2 mgnt-iface	Displays the Device HA Pro management interface.
show device-ha2 sync status	Displays Device HA Pro synchronization status.
show device-ha2 sync summary	Displays Device HA Pro synchronization result.
show device-ha2 virtual-mac	Displays Device HA Pro virtual router MAC address. The active and passive Zyxel Devices form a single 'virtual router' with the MAC address of the active device being the virtual MAC address.
show device-ha2 status	Displays whether or not device HA is activated, the IP addresses of the active and passive devices, heartbeat parameters, failover parameters and monitored interfaces.
show device-ha2 firmware-update check-timeout	Displays how long the active device will wait for a reply ping from the passive device indicating it has fully rebooted.  check-timeout: 1 - 3,600 seconds with 1,800 as the current default
show device-ha2 firmware-update delay	Displays how long the active device will wait before updating its firmware after receiving a reply ping from the passive device.  delay time: 1 - 300 seconds with 10 as the current default
show device-ha2 firmware-update status	Displays the firmware update status.

### 48.5.3 Device HA2 Command Example

This command shows whether Device HA2 is activated and related parameters. Srv-monitor shows if a monitored service daemon on the active Zyxel Device fails. Conn-chk monitor shows if there is

connection check monitoring. When enabled, the passive Zyxel Device takes over when a monitored interface on the active Zyxel Device fails.

```
Router# show device-ha2 activation
active: yes
Router# show device-ha2 status
Active: yes
Srv-monitor: no
Conn-chk monitor: no
Password: 1234
Active Device Management IP: 192.168.177.100
Passive Device Management IP: 192.168.177.101
Subnet Mask: 255.255.255.0
Heartbeat Interval: 2
Heartbeat Fail Tolerance: 2
License-Sync: S122L23030003
Max Failover Count: 5
Current Failover Count: 0
Failover Reset Interval (days): 5
Failover Conn-chk Hold Time: 300
Virtual mac: B0B2DC69A5FE
AP-Image-Sync: no
Disable Session Sync: yes
Router(config)#
```

# CHAPTER 49

## Device Insight

This chapter describes how to:

- View the status and information of the clients connected to the Zyxel Device.
- Create profiles to block specified clients.

### 49.1 Device Insight Overview

**Device Insight** displays the status of the clients connected to the Zyxel Device, such as if a client is sending traffic to the Zyxel Device or if a client's MAC address is in the CDR block list.

It also displays the basic information of the clients. The clients shown may include clients connected to the Zyxel Device:

- **A** - Using wired connections.
- **B** - Through access points (APs) using wired connections.
- **C** - Through access points (APs) using WiFi connections.
- **D** - Through built-in access points using WiFi connections.
- **E** - Using SecuExtender (IPSec VPN clients).

Use **Device Insight** to identify and monitor clients connected to the internal LAN/VLAN DMZ networks of the Zyxel Device in the same IP subnet. This feature collects client information, including:

- Hostname
- IP address and MAC address
- Operating system
- Category, such as mobile phones or computers
- Connected interface

You can create a profile based on clients' categories and operating systems, and then apply the created profile to the Zyxel Device security policies. For example, company A on the Zyxel Device LAN1 wants to block its subsidiary employees on LAN2 from accessing the company A local networks with their mobile phones. Company A can create a profile that includes all operating systems mobile phones, and then apply it to the **LAN2\_To\_LAN1** policy. Clients using mobile phones on the Zyxel Device LAN2 will be blocked from accessing the Zyxel Device LAN1.

Note: To collect clients' information using **Device Insight**, the clients must be in the same IP subnet in the LAN/VLAN/DMZ networks behind the Zyxel Device. Information from clients that are in different IP subnets in the LAN/VLAN/DMZ networks might not be collected correctly as traffic must pass through another router or a layer-3 switch to the Zyxel Device.

Here's the process to use a Device Insight profile in a Zyxel Device security policy. The example below uses the parameters in this table.

Table 236 Device Insight Profile Configuration Example

PROFILE NAME	DESCRIPTION	CATEGORY	OPERATING SYSTEM	APPLIED POLICY
MobilePhone	profile for mobile clients	mobile-phone-tablet	<ul style="list-style-type: none"> <li>• Windows</li> <li>• macOS</li> <li>• Linux</li> <li>• OS</li> <li>• Android</li> <li>• Others</li> </ul>	LAN2_To_LAN1

The security policy **LAN2\_To\_LAN1** uses the parameters in this table.

Table 237 Security Policy Configuration Example

TO	FROM	ACTION	DEVICE INSIGHT PROFILE
LAN1	LAN2	deny	MobilePhone

- 1 Create a Device Insight profile, for example, clients connected to the Zyxel Device LAN using mobile phones.

```
Router# configure terminal
Router(config)# device profile MobilePhone
Router(config)# device profile MobilePhone description profile for mobile clients
Router(config)# device profile MobilePhone category
computer          gaming-consoles      ip-camera          media-player
network-storage   printer                router             switch
firewall          iot                    ip-phone          mobile-phone-
tablet  others                projector          smart-tv          wireless-ap
Router(config)# device profile MobilePhone category mobile-phone-tablet
Router(config)# device profile MobilePhone os
android  ios      linux  macos  others  windows
Router(config)# device profile MobilePhone os android
Router(config)# device profile MobilePhone os ios
Router(config)# device profile MobilePhone os linux
Router(config)# device profile MobilePhone os macos
Router(config)# device profile MobilePhone os others
Router(config)# device profile MobilePhone os windows
```

- 2 Create a new security policy. Name it as **LAN2\_To\_LAN1**.

```
Router(config)# secure-policy 14
Router(config)# name LAN2_To_LAN1
```

- 3 Configure the traffic direction for the security policy **LAN2\_To\_LAN1**. Add the created Device Insight profile to the security policy.

```
Router(config)# from LAN2
Router(config)# to LAN1
Router(config)# device MobilePhone
```

- 4 The Zyxel Device will block clients if they match the settings you configure in the Device Insight profile and the security policy action is set to block.

```
Router(secure-policy)# action deny
Router(secure-policy)# exit
```

## 49.1.1 Device Insight Commands

This table lists the commands for **Device Insight**.

Table 238 Command Summary: Device Insight

COMMAND	DESCRIPTION
show device info all	Displays all connected clients status and information.
show device info mac <mac address>	Displays information of a client with the specified MAC address.
show device info ip <ip address>	Displays information of a client with the specified IP address.
[no] device identify activate	Enables <b>Device Insight</b> to identify connected clients. Use the <b>no</b> command to disable this feature.
show device identify status	Displays whether <b>Device Insight</b> is on or off.
[no] device block mac <mac address>	Blocks a client with the specified MAC address. Use the <b>no</b> command to unblock an MAC address.
[no] device mac <mac address> description <description>	Enters a client MAC address to set a description for the client. Use the <b>no</b> command to delete the description for this client.
show device profile all	Displays all device insight profiles settings.
show device profile <profile name>	Enters a profile name to show the specified profile settings.

The following table describes the commands available for Device Insight. You must use the **configure terminal** commands to enter the configuration mode before you can use the configuration commands. Commands that do not have IPv6 specified in the description are for IPv4.

Table 239 Command Summary: Device Insight Profiles

COMMAND	DESCRIPTION
[no] device profile <profile name>	Creates a Device Insight profile. You may use 1-31 alphanumeric character, underscores (_), or dashes (-), but the first character cannot be a number. Spaces and duplicate names are not allowed. This value is case-sensitive.  Use the <b>no</b> command to delete the specified profile.
device profile rename <profile name> <profile name>	Renames the specified Device Insight profile (first <i>profile name</i> ) to the specified Device Insight profile name (second <i>profile name</i> ).
show reference object device <profile name>	Displays which configuration settings reference the specified Device Insight profile.
[no] device profile <profile name> description <description>	Sets a description for the specified Device Insight profile. You can use up to 60 printable ASCII characters.  Use the <b>no</b> command to delete the description for this profile.

Table 239 Command Summary: Device Insight Profiles (continued)

COMMAND	DESCRIPTION
<pre>[no] device profile &lt;profile name&gt; category &lt;category&gt;</pre>	<p>Configures the type of device used by the connected client for the specified profile. The category includes:</p> <ul style="list-style-type: none"> <li>• Computer</li> <li>• Firewall</li> <li>• Game Consoles</li> <li>• IP Camera</li> <li>• IP Phone</li> <li>• IoT: A device with sensors and software that collects and analyzes data. It exchanges the data it collects with other devices over the Internet.  </li> </ul> <p>For example, a smart watch that your grandparents wear is an IoT. It can detect the heart rate and blood pressure of the person wearing it. It sends out warning to other devices, such as your parents phones, if it detects something wrong.</p> <ul style="list-style-type: none"> <li>• Media Player</li> <li>• Mobile Phone/Tablet</li> <li>• Network Storage</li> <li>• Printer</li> <li>• Projector</li> <li>• Router</li> <li>• Smart TV</li> <li>• Switch</li> <li>• Wireless AP</li> <li>• Others</li> </ul>
<pre>[no] device profile &lt;profile name&gt; os &lt;os&gt;</pre>	<p>Configures the device operating system used by the connected client for the specified profile.</p>
<pre>secure policy &lt;1...500&gt; device &lt;profile name&gt;</pre>	<p>Applies the specified profile to the specified secure policy.</p>

# CHAPTER 50

## User/Group

This chapter describes how to set up user accounts, user groups, and user settings for the Zyxel Device. You can also set up rules that control when users have to log in to the Zyxel Device before the Zyxel Device routes traffic for them.

### 50.1 User Account Overview

A user account defines the privileges of a user logged into the Zyxel Device. User accounts are used in firewall rules and application patrol, in addition to controlling access to configuration and services in the Zyxel Device.

#### 50.1.1 User Types

There are the types of user accounts the Zyxel Device uses.

Table 240 Types of User Accounts

TYPE	ABILITIES	LOGIN METHOD(S)
<b>Admin Users</b>		
Admin	Change Zyxel Device configuration (web, CLI)	WWW, TELNET, SSH, FTP
Limited-Admin	Look at Zyxel Device configuration (web, CLI) Perform basic diagnostics (CLI)	WWW, TELNET, SSH
<b>Access Users</b>		
User	Access network services Browse user-mode commands (CLI)	WWW, TELNET, SSH
Guest	Access network services	WWW
Ext-User	External user account	WWW
ext-group-user	External group user account	WWW

Note: The default **admin** account is always authenticated locally, regardless of the authentication method setting. (See [Chapter 56 on page 465](#) for more information about authentication methods.)

## 50.2 User/Group Commands Summary

The following table identifies the values required for many `username/groupname` commands. Other input values are discussed with the corresponding commands.

Table 241 `username/groupname` Command Input Values

LABEL	DESCRIPTION
<code>username</code>	The name of the user (account). You may use 1-31 alphanumeric characters, underscores( <code>_</code> ), or dashes ( <code>-</code> ), but the first character cannot be a number. This value is case-sensitive.
<code>groupname</code>	The name of the user group. You may use 1-31 alphanumeric characters, underscores( <code>_</code> ), or dashes ( <code>-</code> ), but the first character cannot be a number. This value is case-sensitive. It cannot be the same as the user name.

The following sections list the `username/groupname` commands.

### 50.2.1 User Commands

The first table lists the commands for users.

Table 242 `username/groupname` Commands Summary: Users

COMMAND	DESCRIPTION
<code>show username [username]</code>	Displays information about the specified user or about all users set up in the Zyxel Device.
<code>username username nopassword user-type {admin   guest   limited-admin   user}</code>	Creates the specified user (if necessary), disables the password, and sets the user type for the specified user.
<code>username username password password user-type {admin   guest   limited-admin   user}</code>	Creates the specified user (if necessary); enables and sets the password; and sets the user type for the specified user.  <i>password:</i> You can use 1-63 printable ASCII characters, except double quotation marks ( <code>"</code> ) and question marks ( <code>?</code> ).
<code>username username user-type ext-user</code>	Creates the specified user (if necessary) and sets the user type to <b>Ext-User</b> .
<code>username username user-type mac-address</code>	Creates the specified user (if necessary) and sets the user type to <b>mac-address</b> .
<code>username username user-type ext-group-user associated-aaa-server server_profile group-id id</code>	Specifies the value of the AD or LDAP server's Group Membership Attribute that identifies the group to which the specified ext-group-user type user account belongs.
<code>username username encrypted-password &lt;password&gt;</code>	Sets the password for the specified user.
<code>no username username</code>	Deletes the specified user.
<code>username rename username username</code>	Renames the specified user (first <code>username</code> ) to the specified username (second <code>username</code> ).
<code>username username [no] description description</code>	Sets the description for the specified user. The <code>no</code> command clears the description.  <i>description:</i> You can use alphanumeric and <code>() +/ :=? !*#@\$_% -</code> characters, and it can be up to 60 characters long.



Table 242 username/groupname Commands Summary: Users (continued)

COMMAND	DESCRIPTION
<code>username username logon-time-setting &lt;default   manual&gt;</code>	Sets the account to use the factory default lease and reauthentication times or custom ones.
<code>username username [no] logon-lease-time &lt;0..1440&gt;</code>	Sets the lease time for the specified user. Set it to zero to set unlimited lease time. The <code>no</code> command sets the lease time to five minutes (regardless of the current default setting for new users).
<code>username username [no] logon-re-auth-time &lt;0..1440&gt;</code>	Sets the reauthorization time for the specified user. Set it to zero to set unlimited reauthorization time. The <code>no</code> command sets the reauthorization time to thirty minutes (regardless of the current default setting for new users).
<code>username username [no] email &lt;1..2&gt; email-address</code>	Specifies up to two email addresses for a user account. The <code>no</code> command removes the specified email address for this account.  <i>email-address</i> : Should be in the <code>&lt;user@domainname&gt;</code> format.
<code>username username [no] phone phone_number</code>	Sets the mobile phone number for the account. The <code>no</code> command removes the specified mobile phone number for this account.  <i>phone_number</i> : 20 character length, including numbers 1-9 and characters +*#()-
<code>username username vlan activate</code>	Enables dynamic VLAN assignment for the user account. Dynamic VLAN assignment allows you to assign a user to a specific VLAN based on the user credentials.
<code>username username vlan id &lt;1..4094&gt;</code>	Sets the ID number of the VLAN to which this user account is assigned after authentication is successful.
<code>username username [no] {email1-verify email2-verify}</code>	Sends an authorization email with a code of six digits. The authorization email will be sent to the email address set for the account.
<code>_two-factor-auth-send email email user username verification-code verification_code</code>	Enters the authorization code to verify your email address for the account.
<code>username username [no] phone-verify</code>	Sends an SMS message with a code of six digits. The SMS message will be sent to the mobile phone number set for the account.
<code>sms-service _two-factor-auth-admin-send phone phone user username verification-code verification_code</code>	Enters the authorization code to verify your mobile telephone number for the account.
<code>[no] pwd-expiry force-to-change-pwd activate</code>	Enforces a periodic password change. The <code>no</code> command removes the requirement.
<code>[no] pwd-expiry expiration days &lt;1..365&gt;</code>	Sets how often users must change their password when they log into the Zyxel Device. You can choose from once a day to once a year. The <code>no</code> command removes the requirement.
<code>pwd-expiry link-to-device custom {myrouter   &lt;FQDN&gt;   &lt;IPv6 Address&gt;   &lt;W.X.Y.X&gt;}</code>	Set the host part of the hyperlink in the password expiration notice email. Please note that myrouter is accessible only if the user is in the LAN of this Zyxel Device, and there are no other Zyxel gateways in between.
<code>pwd-expiry expiration send-now</code>	Sends a password expiration e-mail immediately.

Table 242 username/groupname Commands Summary: Users (continued)

COMMAND	DESCRIPTION
[no] password complexity-verify	Enforces a complex user password consisting of at least 8 characters and at most 64. At least 1 character must be a number, at least 1 a lower case letter, at least 1 an upper case letter and at least one special character from the keyboard, such as `~!@#\$\$%^&*()_+={} ;:'<,.>.\^-`  The <i>no</i> command removes the requirement.
show pwd-expiry {all   expiration   force-to-change-pwd   link-to-device}	Displays if a password must be changed ( <i>force-to-change-pwd</i> ), when a password will expire ( <i>expiration</i> ) and the host part of the hyperlink in the password expiration notice email ( <i>link-to-device</i> ).
show password complexity-verify status	Displays if a complex user password as defined above is required.

## 50.2.2 User Group Commands

This table lists the commands for groups.

Table 243 username/groupname Commands Summary: Groups

COMMAND	DESCRIPTION
show groupname [groupname]	Displays information about the specified user group or about all user groups set up in the Zyxel Device.
[no] groupname groupname	Creates the specified user group if necessary and enters sub-command mode. The <i>no</i> command deletes the specified user group.
[no] description description	Sets the description for the specified user group. The <i>no</i> command clears the description for the specified user group.
[no] groupname groupname	Adds the specified user group (second <i>groupname</i> ) to the specified user group (first <i>groupname</i> ).
[no] user username	Adds the specified user to the specified user group.
groupname rename groupname groupname	Renames the specified user group (first <i>groupname</i> ) to the specified group-name (second <i>groupname</i> ).

## 50.2.3 User Setting Commands

This table lists the commands for user settings, except for forcing user authentication.

Table 244 username/groupname Commands Summary: Settings

COMMAND	DESCRIPTION
show users default-setting {all   user-type {admin user guest limited-admin ext-user  ext-group-user}}	Displays the default lease and reauthentication times for the specified type of user accounts.
users default-setting [no] logon-lease-time <0..1440>	Sets the default lease time (in minutes) for each new user. Set it to zero to set unlimited lease time. The <i>no</i> command sets the default lease time to five.

Table 244 username/groupname Commands Summary: Settings (continued)

COMMAND	DESCRIPTION
<code>users default-setting [no] logon-re-auth-time &lt;0..1440&gt;</code>	Sets the default reauthorization time (in minutes) for each new user. Set it to zero to set unlimited reauthorization time. The <code>no</code> command sets the default reauthorization time to thirty.
<code>users default-setting [no] user-type &lt;admin  ext-user guest limited-admin user ext-group-user&gt;</code>	Sets the default user type for each new user. The <code>no</code> command sets the default user type to user.
<code>users default-setting [no] user-type &lt;admin  ext-user guest limited-admin user ext-group-user&gt; logon-lease-time &lt;0..1440&gt;</code>	Sets the default lease time (in minutes) for each type of new user. Set it to zero for unlimited lease time. The <code>no</code> command sets the default lease time to five.
<code>users default-setting [no] user-type &lt;admin  ext-user guest limited-admin user ext-group-user&gt; logon-re-auth-time &lt;0..1440&gt;</code>	Sets the default reauthorization time (in minutes) for each type of new user. Set it to zero for unlimited reauthorization time. The <code>no</code> command sets the default reauthorization time to thirty.
<code>show users retry-settings</code>	Displays the current retry limit settings for users.
<code>[no] users retry-limit</code>	Enables the retry limit for users. The <code>no</code> command disables the retry limit.
<code>[no] users retry-count &lt;1..99&gt;</code>	Sets the number of failed login attempts a user can have before the account or IP address is locked out for lockout-period minutes. The <code>no</code> command sets the retry-count to five.
<code>[no] users lockout-period &lt;1..65535&gt;</code>	Sets the amount of time, in minutes, a user or IP address is locked out after retry-count number of failed login attempts. The <code>no</code> command sets the lockout period to thirty minutes.
<code>show users simultaneous-logon-settings</code>	Displays the current settings for simultaneous logins by users.
<code>[no] users simultaneous-logon {administration   access} enforce</code>	Enables the limit on the number of simultaneous logins by users of the specified account-type. The <code>no</code> command disables the limit, or allows an unlimited number of simultaneous logins.
<code>[no] users simultaneous-logon {administration   access} limit &lt;1..1024&gt;</code>	Sets the limit for the number of simultaneous logins by users of the specified account-type. The <code>no</code> command sets the limit to one.
<code>show users update-lease-settings</code>	Displays whether or not access users can automatically renew their lease time.
<code>[no] users update-lease automation</code>	Lets users automatically renew their lease time. The <code>no</code> command prevents them from automatically renewing it.
<code>show users idle-detection-settings</code>	Displays whether or not users are automatically logged out, and, if so, how many minutes of idle time must pass before they are logged out.
<code>[no] users idle-detection</code>	Enables logging users out after a specified number of minutes of idle time. The <code>no</code> command disables logging them out.
<code>[no] users idle-detection timeout &lt;1..60&gt;</code>	Sets the number of minutes of idle time before users are automatically logged out. The <code>no</code> command sets the idle-detection timeout to three minutes.

### 50.2.3.1 User Setting Command Examples

The following commands show the current settings for the number of simultaneous logins.

```
Router# configure terminal
Router(config)# show users simultaneous-logon-settings
enable simultaneous logon limitation for administration account: yes
maximum simultaneous logon per administration account          : 1
enable simultaneous logon limitation for access account        : yes
maximum simultaneous logon per access account                  : 3
```

### 50.2.4 MAC Auth Commands

This table lists the commands for mappings MAC addresses to MAC address user accounts.

Table 245 mac-auth Commands Summary

COMMAND	DESCRIPTION
[no] mac-auth database mac <i>mac_address</i> type <i>ext-mac-address</i> mac-role <i>username</i> description <i>description</i>	Maps the specified MAC address authenticated by an external server to the specified MAC role (MAC address user account).  The <b>no</b> command deletes the mapping between the MAC address and the MAC role.
[no] mac-auth database mac <i>mac_address</i> type <i>int-mac-address</i> mac-role <i>username</i> description <i>description</i>	Maps the specified MAC address authenticated by the Zyxel Device's local user database to the specified MAC role (MAC address user account).  The <b>no</b> command deletes the mapping between the MAC address and the MAC role.
[no] mac-auth database mac <i>oui</i> type <i>ext-oui</i> mac-role <i>username</i> description <i>description</i>	Maps the specified OUI (Organizationally Unique Identifier) authenticated by an external server to the specified MAC role (MAC address user account). The OUI is the first three octets in a MAC address and uniquely identifies the manufacturer of a network device.  The <b>no</b> command deletes the mapping between the OUI and the MAC role.
[no] mac-auth database mac <i>oui</i> type <i>int-oui</i> mac-role <i>username</i> description <i>description</i>	Maps the specified OUI (Organizationally Unique Identifier) authenticated by the Zyxel Device's local user database to the specified MAC role (MAC address user account). The OUI is the first three octets in a MAC address and uniquely identifies the manufacturer of a network device.  The <b>no</b> command deletes the mapping between the OUI and the MAC role.

#### 50.2.4.1 MAC Auth Example

This example uses an external server to authenticate wireless clients by MAC address. After authentication the Zyxel Device maps the wireless client to a mac-address user account (MAC role). Configure user-aware features to control MAC address user access to network services.

The following commands:

- Create a MAC role (mac-address user type user account) named Zyxel-mac

- Map a wireless client's MAC address of 00:13:49:11:a0:c4 to the Zyxel-mac MAC role (MAC address user account)
- Modify the WLAN security profile named secureWLAN1 as follows:
  - Turn on MAC authentication
  - Use the authentication method named Auth1
  - Use colons to separate the two-character pairs within account MAC addresses
  - Use upper case letters in the account MAC addresses

```
Router(config)# username Zyxel-mac user-type mac-address
Router(config)# mac-auth database mac 00:13:49:11:a0:c4 type ext-mac-address
mac-role Zyxel-mac description zyxel mac

3. Modify wlan-security-profile
Router(config)# wlan-security-profile secureWLAN1
Router(config-wlan-security default)# mac-auth activate
Router(config-wlan-security default)# mac-auth auth-method Auth1
Router(config-wlan-security default)# mac-auth delimiter account colon
Router(config-wlan-security default)# mac-auth case account upper
Router(config-wlan-security default)# exit
```

## 50.2.5 Additional User Commands

This table lists additional commands for users.

Table 246 username/groupname Commands Summary: Additional

COMMAND	DESCRIPTION
show users {username   all   current}	Displays information about the users logged onto the system.
show lockout-users	Displays users who are currently locked out.
unlock lockout-users {ip   console   ipv6_addr}	Unlocks the specified IP address.
users force-logout {username   ip   ipv6_addr}	Logs out the specified login.

### 50.2.5.1 Additional User Command Examples

The following commands display the users that are currently logged in to the Zyxel Device and forces

the logout of all logins from a specific IP address.

```
Router# configure terminal
Router(config)# show users all
No: 1
  Name: admin
  Type: admin
  From: 172.21.40.9
  Country_Code: RIP
  Country_Name: Private IP
  MAC: DC:4A:3E:40:EC:67
  Associated AP: -
  Service: http/https
  Login_Time: 03:59:48
  Idle_Time: unlimited
  Lease_Timeout: 21:59:49
  Re_Auth_Timeout: 20:00:12
  Remaining_Time: n/a
  Total_Quota: -
  Upload_quota: -
  Download_quota: -
  Upload_Bandwidth: unlimited
  Upload_Bandwidth_Priority: 7
  Download_Bandwidth: unlimited
  Download_Bandwidth_Priority: 7
  Session_Timeout: unlimited
  Acct. Status: -
  Profile Name: N/A
  User_Info: admin(admin)
  Mobile: N/A
  Email: N/A
No: 2
  Name: admin
  Type: admin
  From: console
  Country_Code: -
  Country_Name: -
  MAC: -
  Associated AP: -
  Service: console
  Login_Time: 02:07:23
  Idle_Time: unlimited
  Lease_Timeout: 24:00:00
  Re_Auth_Timeout: 21:52:37
  Remaining_Time: n/a
  Total_Quota: -
  Upload_quota: -
  Download_quota: -
  Upload_Bandwidth: unlimited
  Upload_Bandwidth_Priority: 7
  Download_Bandwidth: unlimited
  Download_Bandwidth_Priority: 7
  Session_Timeout: unlimited
  Acct. Status: -
  Profile Name: N/A
  User_Info: admin(admin)
  Mobile: N/A
  Email: N/A
```

The following commands display the users that are currently locked out and then unlocks the user who is displayed.

```
Router# configure terminal
Router(config)# show lockout-users
No.  Username Tried          From          Lockout Time Remaining
=====
No.  From          Failed Login Attempt  Record Expired Timer
=====
1    172.16.1.5      2                46

Router(config)# unlock lockout-users 172.16.1.5
User from 172.16.1.5 is unlocked
Router(config)# show lockout-users
No.  Username Tried          From          Lockout Time Remaining
=====
No.  From          Failed Login Attempt  Record Expired Timer
=====
```



# CHAPTER 51

## Application Object

Check that you have the latest IDP and App Patrol signatures.

### 51.1 Application Object Commands Summary

The following table describes the values required for many application object commands. Other values are discussed with the corresponding commands.

Table 247 Input Values for Application Object Commands

LABEL	DESCRIPTION
<code>&lt;object&gt;</code>	Type the name of the object.
<code>&lt;description&gt;</code> >	This is a description of the object
<code>&lt;sid&gt;</code>	This is the associated IDP and App Patrol signature ID number.

#### 51.1.1 Application Object Commands

This table lists the application object commands.

Table 248 application-object Commands

COMMAND	DESCRIPTION
<code>show application-object &lt;object&gt;</code>	Displays information on the named application object.
<code>application-object &lt;object&gt;</code>	Creates an object with the specified name. You may use 1-31 alphanumeric characters, underscores( <code>_</code> ), or dashes( <code>-</code> ), but the first character cannot be a number. This value is case-sensitive. The <code>no</code> command disables it.
<code>[no] description &lt;description&gt;</code>	Write a description of the object.
<code>[no] application &lt;sid&gt;</code>	Write a valid signature ID for the object. The <code>no</code> command disables it.
<code>no application-object &lt;object&gt;</code>	Deletes the object with the specified name.
<code>application-object rename &lt;object&gt;</code> <code>&lt;object&gt;</code>	Renames the specified object with a new name.

### 51.1.1.1 application-object Examples

These are some example usage commands.

```
Router(config)# show application-object
Name
Description                                     Ref
Content
=====
=====
tests
New Create                                     1
Facebook Game (access)
Router(config)# show application-object tests
Name: tests
Description: New Create
Category                                     Application
Application ID
=====
=====
Social Network                               Facebook Game (access)
402685702
Router(config)#
```

### 51.1.2 Application Object Group Commands

This table lists the application object group commands.

Table 249 object-group application Commands

COMMAND	DESCRIPTION
show object-group application <object>	Displays information on the named application object group.
object-group application <object>	Creates an object group. with the specified name. You may use 1-31 alphanumeric characters, underscores(_), or dashes (-), but the first character cannot be a number. This value is case-sensitive. The no command disables it.
[no] description <description>	Write a description of the object group.
[no] application-object <object>	Adds the named application object to the object group. The no command removes it.
[no] object-group <object>	Creates an object group. The no command removes it.
no object-group application <object>	Deletes the object group with the specified name.
object-group application rename <object> <object>	Renames the specified object group with a new name.

### 51.1.2.1 object-group application Examples

These are some example usage commands.

```

Router(config)# show object-group application
Name
Description                               Ref
Member
=====
=====
Router(config)# object-group application may
Router(group-application)# description rinse after use
Router(group-application)# exit
Router(config)# show object-group application
Name
Description                               Ref
Member
=====
=====
may
rinse after use                           0
tests
Router(config)#

```

# CHAPTER 52

## Addresses

This chapter describes how to set up addresses and address groups for the Zyxel Device.

### 52.1 Address Overview

Address objects can represent a single IP address or a range of IP addresses. Address groups are composed of address objects and other address groups.

You can create IP address objects based on an interface's IP address, subnet, or gateway. The Zyxel Device automatically updates these objects whenever the interface's IP address settings change. This way every rule or setting that uses the object uses the updated IP address settings. For example, if you change the LAN1 interface's IP address, the Zyxel Device automatically updates the corresponding interface-based, LAN1 subnet address object. So any configuration that uses the LAN1 subnet address object is also updated.

Address objects and address groups are used in dynamic routes, firewall rules, application patrol, content filtering, and VPN connection policies. For example, addresses are used to specify where content restrictions apply in content filtering. Please see the respective sections for more information about how address objects and address groups are used in each one.

Address groups are composed of address objects and address groups. The sequence of members in the address group is not important.

### 52.2 Address Commands Summary

The following table describes the values required for many address object and address group commands. Other values are discussed with the corresponding commands.

Table 250 Input Values for Address Commands

LABEL	DESCRIPTION
<i>object_name</i>	The name of the address. You may use 1-31 alphanumeric characters, underscores( <code>_</code> ), or dashes ( <code>-</code> ), but the first character cannot be a number. This value is case-sensitive.

Table 250 Input Values for Address Commands (continued)

LABEL	DESCRIPTION
<i>group_name</i>	The name of the address group. You may use 1-31 alphanumeric characters, underscores(_), or dashes (-), but the first character cannot be a number. This value is case-sensitive.
<i>interface_name</i>	<p>The name of the interface. This depends on the Zyxel Device model.</p> <p>For some models, use <i>gex</i>, <i>x</i> = 1 - N, where N equals the highest numbered Ethernet interface for your Zyxel Device model.</p> <p>For other models, use a name such as <i>wan1</i>, <i>wan2</i>, <i>opt</i>, <i>lan1</i>, or <i>dmz</i>.</p>

The following sections list the address object and address group commands.

## 52.2.1 Address Object Commands

There are the types of address objects:

- **HOST** - the object uses an **IP Address to define** a host address
- **RANGE** - the object uses a range address defined by a **Starting IP Address** and an **Ending IP Address**
- **SUBNET** - the object uses a network address defined by a **Network** IP address and **Netmask** subnet mask
- **INTERFACE IP** - the object uses the IP address of one of the Zyxel Device's interfaces
- **INTERFACE SUBNET** - the object uses the subnet mask of one of the Zyxel Device's interfaces
- **INTERFACE GATEWAY** - the object uses the gateway IP address of one of the Zyxel Device's interfaces
- **GEOGRAPHY** - the object uses the IP addresses of a country to represent a country
- **FQDN** - the object uses a FQDN (Fully Qualified Domain Name). An FQDN consists of a host and domain name. For example, *www.zyxel.com* is a fully qualified domain name. FQDN in address objects can be used in Security Policy, Policy Route, BWM and Web Authentication profiles as source and destination criteria. FQDN with a wildcard (for example, *\*.zyxel.com*) can be used in these profiles as destination criteria only. An FQDN is resolved to its IP address using the DNS server configured on the Zyxel Device. If the Zyxel Device receives a DNS query for an FQDN and the Zyxel Device has an FQDN cache entry, the Zyxel Device can map the IP address in a DNS response without having to query a DNS name server.

This table lists the commands for address objects.

Table 251 address-object and address6-object Commands

COMMAND	DESCRIPTION
<code>show {address-object   address6-object   service-object   schedule-object} [object_name]</code>	Displays information about the specified object or all the objects of the specified type.
<code>address-object object_name {ip   ip_range   ip_subnet   fqdn fqdn   geography country code   interface-ip   interface-subnet   interface-gateway} {interface_name   virtual interface name}</code>	Creates the specified IPv4 address object using the specified parameters.  <i>ip</i> <W.X.Y.Z> Enter an IPv4 address.  <i>ip_range</i> <W.X.Y.Z>-<W.X.Y.Z> Enter an IPv4 address range.  <i>ip_subnet</i> <W.X.Y.Z>/<1..32> Enter an IPv4 subnet in CIDR format. For example, 192.168.1.0/32.  <i>fqdn</i> Enter a fully-qualified domain name.  <i>country code</i> Enter a country or continent code (represents an IP address for that country/continent).  <i>interface-gateway / interface-ip / interface-subnet</i> Enter an <i>interface_name</i> or a <i>virtual_interface_name</i>
<code>address-object object_name geography &lt;country code&gt; all</code>	Creates a GEOGRAPHY object representing all IPv4 address of the specified country.  Use the command, <code>geo-ip [no] geography &lt;country_code&gt; all address {ipv4   ip6}</code> , to configure the custom country-to-IP/continent-to-IP address mappings for a GEOGRAPHY object.
<code>no address-object object_name</code>	Deletes the specified address object.
<code>address-object rename object_name object_name</code>	Renames the specified address (first <i>object_name</i> ) to the second <i>object_name</i> .
<code>address6-object object_name {ip   ip_range   ip_subnet   fqdn fqdn   geography country code   interface-ip   interface-subnet   interface-gateway} {interface_name   virtual interface name}</code>	Creates the specified IPv6 address object using the specified parameters.  <i>ip</i> <W.X.Y.Z> Enter an IPv6 address.  <i>ip_range</i> <W.X.Y.Z>-<W.X.Y.Z> Enter an IPv6 address range.  <i>ip_subnet</i> <W.X.Y.Z>/<1..32> Enter an IPv6 subnet. For example, 192.168.1.0/32.  <i>fqdn</i> Enter a fully-qualified domain name.  <i>country code</i> Enter a country or continent code (represents an IP address for that country/continent).  <i>interface-gateway / interface-ip / interface-subnet</i> Enter an <i>interface_name</i> or a <i>virtual_interface_name</i>
<code>address6-object object_name geography &lt;country code&gt; all</code>	Creates a GEOGRAPHY object representing all IPv6 address of the specified country.  Use the command, <code>geo-ip [no] geography &lt;country_code&gt; all address {ipv4   ip6}</code> , to configure the custom country-to-IP/continent-to-IP address mappings for a GEOGRAPHY object.

Table 251 address-object and address6-object Commands (continued)

COMMAND	DESCRIPTION
[no] address6-object <i>object_name</i> { <i>ipv6_address</i>   <i>ipv6_range</i>   <i>ipv6_subnet</i> }	Creates the specified IPv6 address object using the specified parameters. The no command removes the specified address object.  <i>ipv6_address</i> : IPv6 address  <i>ipv6_range</i> : IPv6 address range. For example: fe80:1234::1-fe80:1234::ffff  <i>ipv6_subnet</i> : IPv6 prefix format. For example: fe80::211:85ff:fe0e:dec/128
[no] address6-object OBJECT_NAME interface-ip interface {dhcpv6   link- local   slaac   static} {addr_index}	Creates the specified IPv6 address object based on the specified interface object. Specify whether it is a DHCPv6 server, link-local IP address, Stateless Address Auto Configuration IP address (slaac), or static IPv6 address. The no command removes the specified address object.
[no] address6-object <i>object_name</i> interface-subnet <i>interface</i> {dhcpv6   slaac   static} {addr_index}	Creates the specified IPv6 address object based on the specified interface subnet object. Specify whether it is a DHCPv6 server, SLAAC, or static IPv6 address. The no command removes the specified address object.
[no] address6-object <i>object_name</i> interface-gateway <i>interface</i> {slaac   static} {addr_index}	Creates the specified IPv6 address object based on the specified interface gateway object. Specify whether it is a SLAAC or static IPv6 address. The no command removes the specified address object.
fqdn-object query-period <1..1440>	Configures how long (1-1440 seconds) the Zyxel Device should wait for a reply from the DNS server configured on the Zyxel Device in order to update FQDN - IP cache entries.
fqdn-object sync-period <1..5>	Configures how often (1-5 seconds) the Zyxel Device should query the DNS server configured on the Zyxel Device to update FQDN - IP cache entries.
fqdn-object test <i>fqdn</i>	<i>fqdn</i> Tests an FQDN object by entering a fully-qualified domain name.
show fqdn-object all	Displays all FQDN objects with IPv4 addresses configured on the Zyxel Device.
show fqdn-object6 all	Displays all FQDN objects with IPv6 addresses configured on the Zyxel Device.
show fqdn	Displays the FQDN host name and domain name configured on the Zyxel Device.
show fqdn-object query-period	Displays how often (1-5 seconds) the Zyxel Device should query the DNS server configured on the Zyxel Device to update FQDN - IP cache entries.
show fqdn-object sync-period	Displays how often (1-5 seconds) the Zyxel Device should query the DNS server configured on the Zyxel Device to update FQDN - IP cache entries.

### 52.2.1.1 Address Object Command Examples

The following example creates three IPv4 address objects and then deletes one.

```
Router# configure terminal
Router(config)# address-object A0 192.168.1.1
Router(config)# address-object A1 192.168.1.1-192.168.1.20
Router(config)# address-object A2 192.168.1.0/24
Router(config)# show address-object
Object name          Type      Address                               Ref.
=====
A0                   HOST      192.168.1.1                          0
A1                   RANGE     192.168.1.1-192.168.1.20            0
A2                   SUBNET    192.168.1.0/24                       0
Router(config)# no address-object A2
Router(config)# show address-object
Object name          Type      Address                               Ref.
=====
A0                   HOST      192.168.1.1                          0
A1                   RANGE     192.168.1.1-192.168.1.20            0
```

The following example shows FQDN command usage.

```
Router# show fqdn
host name   : usg110
domain name: none
FQDN       : usg110
Router# show fqdn-object query-period
FQDN Object Query Period: 2
Router# show fqdn-object sync-period
FQDN Object Sync Period: 1
Router(config)# fqdn-object test usg110
FQDN: usg110
Address
=====
127.0.0.1
Router(config)#
```



The following example creates host, range, subnet, and link local IPv6 address objects and then deletes the subnet IPv6 address object.

```
> enable
Router# configure terminal
Router(config)# address6-object B0 fe80::211:85ff:fe0e:cdec
Router(config)# address6-object B1 fe80::211:85ff:fe0e:1-fe80::211:85ff:fe0e:ff
Router(config)# address6-object B2 fe80::211:85ff:fe0e:cdec/128
Router(config)# address6-object B3 interface-ip ge1 link-local
Router(config)# show address6-object
Object name                Type                Address Type                Index
Address
Note                        Ref.
=====
B0                          HOST
fe80::211:85ff:fe0e:cdec
                        0
B1                          RANGE
fe80::211:85ff:fe0e:1-fe80::211:85ff:fe0e:ff
                        0
B2                          SUBNET
fe80::211:85ff:fe0e:cdec/128
                        0
B3                          INTERFACE IP        LINK LOCAL                    1
fe80::213:49ff:feaa:cb88
ge1                        0

Router(config)# no address6-object B2
Router(config)# show address6-object
Object name                Type                Address Type                Index
Address
Note                        Ref.
=====
B0                          HOST
fe80::211:85ff:fe0e:cdec
                        0
B1                          RANGE
fe80::211:85ff:fe0e:1-fe80::211:85ff:fe0e:ff
                        0
B3                          INTERFACE IP        LINK LOCAL                    1
fe80::213:49ff:feaa:cb88
ge1                        0
```

## 52.2.2 Address Group Commands

This table lists the commands for address groups.

Table 252 object-group Commands: Address Groups

COMMAND	DESCRIPTION
show object-group {address   address6} [group_name]	Displays information about the specified address group or about all address groups.
[no] object-group address group_name	Creates the specified address group if necessary and enters sub-command mode. The no command deletes the specified address group.

Table 252 object-group Commands: Address Groups (continued)

COMMAND	DESCRIPTION
[no] address-object <i>object_name</i>	Adds the specified address to the specified address group. The no command removes the specified address from the specified group.
[no] object-group <i>group_name</i>	Adds the specified address group (second <i>group_name</i> ) to the specified address group (first <i>group_name</i> ). The no command removes the specified address group from the specified address group.
[no] description <i>description</i>	Sets the description to the specified value. The no command clears the description.  <i>description</i> : You can use alphanumeric and ( ) + / : = ? ! * # @ \$ _ % - characters, and it can be up to 60 characters long.
object-group address rename <i>group_name group_name</i>	Renames the specified address group from the first <i>group_name</i> to the second <i>group_name</i> .

### 52.2.2.1 Address Group Command Examples

The following commands create three address objects A0, A1, and A2 and add A1 and A2 to address group RD.

```

Router# configure terminal
Router(config)# address-object A0 192.168.1.1
Router(config)# address-object A1 192.168.1.2-192.168.2.20
Router(config)# address-object A2 192.168.3.0/24
Router(config)# object-group address RD
Router(group-address)# address-object A1
Router(group-address)# address-object A2
Router(group-address)# exit
Router(config)# show object-group address
Group name          Reference
Description
=====
TW_TEAM             5
RD                  0

Router(config)# show object-group address RD
Object/Group name   Type   Reference
=====
A1                  Object 1
A2                  Object 1
    
```

### 52.2.3 FQDN Object

If the Zyxel Device receives a DNS query for an FQDN and the Zyxel Device has an FQDN cache entry, the Zyxel Device can map the IP address in a DNS response without having to query a DNS name server.

FQDN can be used in Security Policy, Policy Route, BWM and Web Authentication profiles as source and destination criteria. FQDN with a wildcard (for example, \*.zyxel.com) can be used in these profiles as destination criteria only.

## 52.2.4 Geo IP

Use these commands to update the database of country-to-IP address mappings and manually configure custom country-to-IP address mappings in geographic address objects. You can then use geographic address objects in security policies to forward or deny traffic to whole countries or regions.

Note: You need to have a registered Content Filter 2.0 Service license to use the country-to-IP and continent-to-IP address database.

## 52.2.5 FQDN / Geo IP Commands

You must be in configuration mode (`configure terminal`) to use the indented commands shown below.

Table 253 FQDN / Geo IP Commands

COMMAND	DESCRIPTION
<code>[no] geo-ip database update auto</code>	Enables the Zyxel Device to automatically check for the latest country-to-IP-address database version on myZyxel.com and allows it to be automatically updated when there is newer version available.  The <code>no</code> command disallows the Zyxel Device automatically checking for the latest country-to-IP-address database version on myZyxel.com.
<code>geo-ip database update country</code>	Updates the country-to-IP-address database for all countries.
<code>geo-ip database update weekly {fri   mon   sat   sun   thu   tue   wed} &lt;0..23&gt;</code>	Specifies the weekly day and time the Zyxel Device should check for the latest country-to-IP-address database version on myZyxel.com if automatic checking is enabled.
<code>geo-ip [no] geography &lt;country_code&gt; all address {ipv4   ipv6}</code>	Creates a new geography-to-IP-address mapping for the specified country. Use <code>show geo-ip country-code</code> to see the 2-letter abbreviation for each country.  The <code>no</code> command removes the new geography-to-IP-address mapping for the specified country.
<code>show geo-ip database update</code>	Shows if the country-to-IP address database is automatically updated and the schedule.
<code>show geo-ip database version</code>	Shows the latest and current country-to-IP-address database version.
<code>show geo-ip database version country</code>	Shows the latest and current country-to-IP-address database version.
<code>show geo-ip country-code</code>	Shows the 2-letter abbreviation for each country.
<code>show geo-ip country-list region code</code>	Shows the countries that belong to the continent.
<code>show geo-ip region-code</code>	Shows the 2-letter abbreviation for each continent.
<code>show geo-ip geography</code>	Shows customized country-to-IPv4-address mappings.
<code>show geo-ip geography6</code>	Shows customized country-to-IPv6-address mappings.

## 52.2.6 Geo IP Command Examples

The following shows Geo IP command examples.

```
Router(config)# geo-ip database update auto
Router(config)# geo-ip database update weekly thu 17
Router(config)# exit
Router# show geo-ip database update
auto: yes
schedule: weekly at Thursday 17 o'clock
Router# show geo-ip database version
country latest version : 20150921
country current version : 20150921
Router# show geo-ip database version country
country latest version : 20150921
country current version : 20150921
Router# show geo-ip geography
Customize IPv4 to Geolocation:
Geolocation      Type      Address
Note
=====
Router# show geo-ip geography6
Customize IPv6 to Geolocation:
Geolocation      Type      Address
Note
=====
Router#
```

# CHAPTER 53

## Services

Use service objects to define TCP applications, UDP applications, and ICMP messages. You can also create service groups to refer to multiple service objects in other features.

### 53.1 Services Overview

See the appendices in the web configurator's User Guide for a list of commonly-used services.

### 53.2 Services Commands Summary

The following table describes the values required for many service object and service group commands. Other values are discussed with the corresponding commands.

Table 254 Input Values for Service Commands

LABEL	DESCRIPTION
<i>group_name</i>	The name of the service group. You may use 1-31 alphanumeric characters, underscores(_), or dashes (-), but the first character cannot be a number. This value is case-sensitive.
<i>object_name</i>	The name of the service. You may use 1-31 alphanumeric characters, underscores(_), or dashes (-), but the first character cannot be a number. This value is case-sensitive.

The following sections list the service object and service group commands.

#### 53.2.1 Service Object Commands

The first table lists the commands for service objects.

Table 255 service-object Commands: Service Objects

COMMAND	DESCRIPTION
<code>show service-object [<i>object_name</i>]</code>	Displays information about the specified service or about all the services.
<code>no service-object <i>object_name</i></code>	Deletes the specified service.
<code>service-object <i>object_name</i> {tcp   udp} {eq &lt;1..65535&gt;   range &lt;1..65535&gt; &lt;1..65535&gt;}</code>	Creates the specified TCP service or UDP service using the specified parameters.

Table 255 service-object Commands: Service Objects (continued)

COMMAND	DESCRIPTION
<code>service-object <i>object_name</i> icmp <i>icmp_value</i></code>	Creates the specified ICMP message using the specified parameters.  <i>icmp_value</i> : <0..255>   alternate-address   conversion-error   echo   echo-reply   information-reply   information-request   mask-reply   mask-request   mobile-redirect   parameter-problem   redirect   router-advertisement   router-solicitation   source-quench   time-exceeded   timestamp-reply   timestamp-request   unreachable
<code>service-object <i>object_name</i> protocol &lt;1..255&gt;</code>	Creates the specified user-defined service using the specified parameters.
<code>service-object rename <i>object_name</i> <i>object_name</i></code>	Renames the specified service from the first <i>object_name</i> to the second <i>object_name</i> .
<code>service-object <i>object_name</i> icmpv6 {&lt;0..255&gt;   neighbor-solicitation   router-advertisement   echo   packet-toobig   router-solicitation   echo-reply   parameter-problem   time-exceeded   neighbor-advertisement   redirect   unreachable}</code>	Creates the specified ICMPv6 message using the specified parameters.

### 53.2.1.1 Service Object Command Examples

The following commands create four services, displays them, and then removes one of them.

```
Router# configure terminal
Router(config)# service-object TELNET tcp eq 23
Router(config)# service-object FTP tcp range 20 21
Router(config)# service-object ICMP_ECHO icmp echo
Router(config)# service-object MULTICAST protocol 2
Router(config)# show service-object
Object name          Protocol          Minmum port      Maxmum port      Ref.
=====TELNET
TCP                  23               23               0
FTP                  TCP              20               21               0
ICMP_ECHO           ICMP              0                0                0
MULTICAST           2                0                0                0
Router(config)# no service-object ICMP_ECHO
Router(config)# show service-object
Object name          Protocol          Minmum port      Maxmum port      Ref.
=====TELNET
TCP                  23               23               0
FTP                  TCP              20               21               0
MULTICAST           2                0                0                0
```

## 53.2.2 Service Group Commands

The first table lists the commands for service groups.

Table 256 object-group Commands: Service Groups

COMMAND	DESCRIPTION
<code>show object-group service <i>group_name</i></code>	Displays information about the specified service group.
<code>[no] object-group service <i>group_name</i></code>	Creates the specified service group if necessary and enters sub-command mode. The <code>no</code> command removes the specified service group.
<code>[no] service-object <i>object_name</i></code>	Adds the specified service to the specified service group. The <code>no</code> command removes the specified service from the specified group.
<code>[no] object-group <i>group_name</i></code>	Adds the specified service group (second <i>group_name</i> ) to the specified service group (first <i>group_name</i> ). The <code>no</code> command removes the specified service group from the specified service group.
<code>[no] description <i>description</i></code>	Sets the description to the specified value. The <code>no</code> command removes the description.  <i>description</i> : You can use alphanumeric and () +/ : = ? ! * # @ \$ _ % - characters, and it can be up to 60 characters long.
<code>object-group service rename <i>group_name group_name</i></code>	Renames the specified service group from the first <i>group_name</i> to the second <i>group_name</i> .

### 53.2.2.1 Service Group Command Examples

The following commands create service ICMP\_ECHO, create service group SG1, and add ICMP\_ECHO to SG1.

```

Router# configure terminal
Router(config)# service-object ICMP_ECHO icmp echo
Router(config)# object-group service SG1
Router(group-service)# service-object ICMP_ECHO
Router(group-service)# exit
Router(config)# show service-object ICMP_ECHO
Object name          Protocol          Minmum port      Maxmum port      Ref.
=====
ICMP_ECHO            ICMP              8                 8                 1
Router(config)# show object-group service SG1
Object/Group name    Type              Reference
=====
ICMP_ECHO            Object 1

```

# CHAPTER 54

## Schedules

Use schedules to set up one-time and recurring schedules for policy routes, firewall rules, application patrol, and content filtering.

### 54.1 Schedule Overview

The Zyxel Device supports two types of schedules: one-time and recurring. One-time schedules are effective only once, while recurring schedules usually repeat.

Note: Schedules are based on the current date and time in the Zyxel Device.

One-time schedules begin on a specific start date and time and end on a specific stop date and time. One-time schedules are useful for long holidays and vacation periods.

Recurring schedules begin at a specific start time and end at a specific stop time on selected days of the week (Sunday, Monday, Tuesday, Wednesday, Thursday, Friday, and Saturday). Recurring schedules always begin and end in the same day. Recurring schedules are useful for defining the workday and off-work hours.

### 54.2 Schedule Commands Summary

The following table describes the values required for many schedule commands. Other values are discussed with the corresponding commands.

Table 257 Input Values for Schedule Commands

LABEL	DESCRIPTION
<i>object_name</i>	The name of the schedule. You may use 1-31 alphanumeric characters, underscores( <code>_</code> ), or dashes ( <code>-</code> ), but the first character cannot be a number. This value is case-sensitive.
<i>time</i>	24-hour time, hours and minutes; <0..23>:<0..59>.

The following table lists the schedule commands.

Table 258 schedule Commands

COMMAND	DESCRIPTION
<code>show schedule-object</code>	Displays information about the schedules in the Zyxel Device.
<code>no schedule-object <i>object_name</i></code>	Deletes the schedule object.



Table 258 schedule Commands (continued)

COMMAND	DESCRIPTION
<code>schedule-object <i>object_name</i> <i>date</i> <i>time</i> <i>date</i> <i>time</i></code>	Creates or updates a one-time schedule. <i>date</i> : yyyy-mm-dd date format; yyyy-<01..12>-<01..31>
<code>schedule-object <i>object_name</i> <i>time</i> <i>time</i> [<i>day</i>] [<i>day</i>] [<i>day</i>] [<i>day</i>] [<i>day</i>] [<i>day</i>] [<i>day</i>]</code>	Creates or updates a recurring schedule. <i>day</i> : 3-character day of the week; sun   mon   tue   wed   thu   fri   sat

## 54.2.1 Schedule Command Examples

The following commands create recurring schedule SCHEDULE1 and one-time schedule SCHEDULE2 and then delete SCHEDULE1.

```
Router# configure terminal
Router(config)# schedule-object SCHEDULE1 11:00 12:00 mon tue wed thu fri
Router(config)# schedule-object SCHEDULE2 2006-07-29 11:00 2006-07-31 12:00
Router(config)# show schedule-object
Object name          Type      Start/End          Ref.
=====
SCHEDULE1            Recurring 11:00/12:00 ===MonTueWedThuFri=== 0
SCHEDULE2            Once      2006-07-29 11:00/2006-07-31 12:00 0

Router(config)# no schedule-object SCHEDULE1
Router(config)# show schedule-object
Object name          Type      Start/End          Ref.
=====
SCHEDULE2            Once      2006-07-29 11:00/2006-07-31 12:00 0
```

# CHAPTER 55

## AAA Server

This chapter introduces and shows you how to configure the Zyxel Device to use external authentication servers.

### 55.1 AAA Server Overview

You can use an AAA (Authentication, Authorization, Accounting) server to provide access control to your network.

The following lists the types of authentication server the Zyxel Device supports.

- Local user database  
The Zyxel Device uses the built-in local user database to authenticate administrative users logging into the Zyxel Device's web configurator or network access users logging into the network through the Zyxel Device. You can also use the local user database to authenticate VPN users.
- Directory Service (LDAP/AD)  
LDAP (Lightweight Directory Access Protocol)/AD (Active Directory) is a directory service that is both a directory and a protocol for controlling access to a network. The directory consists of a database specialized for fast information retrieval and filtering activities. You create and store user profile and login information on the external server.
- RADIUS  
RADIUS (Remote Authentication Dial-In User Service) authentication is a popular protocol used to authenticate users by means of an external or built-in RADIUS server. RADIUS authentication allows you to validate a large number of users from a central location.

### 55.2 Authentication Server Command Summary

This section describes the commands for authentication server settings.

#### 55.2.1 ad-server Commands

The following table lists the `ad-server` commands you use to set the default AD server.

Table 259 ad-server Commands

COMMAND	DESCRIPTION
<code>show ad-server</code>	Displays the default AD server settings.
<code>[no] ad-server basedn basedn</code>	Sets a base distinguished name (DN) for the default AD server. A base DN identifies an AD directory. The <code>no</code> command clears this setting.

Table 259 ad-server Commands (continued)

COMMAND	DESCRIPTION
[no] ad-server binddn <i>binddn</i>	Sets the user name the Zyxel Device uses to log into the default AD server. The <b>no</b> command clears this setting.
[no] ad-server cn-identifier <i>uid</i>	Sets the unique common name (cn) to identify a record. The <b>no</b> command clears this setting.
[no] ad-server host <i>ad_server</i>	Sets the AD server address. Enter the IP address (in dotted decimal notation) or the domain name. The <b>no</b> command clears this setting.
[no] ad-server password <i>password</i>	Sets the bind password. This password will be encrypted when you use the <b>show ad-server</b> command to display. The <b>no</b> command clears this setting.
[no] ad-server password-encrypted <i>password</i>	Sets the encrypted password (less than 32 alphanumeric characters) in order to hide the real password from people behind you when you are configuring AD server password. This password is displayed as what you typed when you use the <b>show ad-server</b> command.
[no] ad-server port <i>port_no</i>	Sets the AD port number. Enter a number between 1 and 65535. The default is 389. The <b>no</b> command clears this setting.
[no] ad-server search-time-limit <i>time</i>	Sets the search timeout period (in seconds). Enter a number between 1 and 300. The <b>no</b> command clears this setting.
[no] ad-server ssl	Enables the Zyxel Device to establish a secure connection to the AD server. The <b>no</b> command disables this feature.

## 55.2.2 Ldap-server Commands

The following table lists the `ldap-server` commands you use to set the default LDAP server.

Table 260 ldap-server Commands

COMMAND	DESCRIPTION
<b>show ldap-server</b>	Displays current LDAP server settings.
[no] ldap-server basedn <i>basedn</i>	Sets a base distinguished name (DN) for the default LDAP server. A base DN identifies an LDAP directory. The <b>no</b> command clears this setting.
[no] ldap-server binddn <i>binddn</i>	Sets the user name the Zyxel Device uses to log into the default LDAP server.  The <b>no</b> command clears this setting.
[no] ldap-server cn-identifier <i>uid</i>	Sets the unique common name (cn) to identify a record.  The <b>no</b> command clears this setting.
[no] ldap-server host <i>ldap_server</i>	Sets the LDAP server address. Enter the IP address (in dotted decimal notation) or the domain name. The <b>no</b> command clears this setting.
[no] ldap-server password <i>password</i>	Sets the bind password. The <b>no</b> command clears this setting.
[no] ldap-server password-encrypted <i>password</i>	Sets an encrypted bind password. The <b>no</b> command clears this setting.
[no] ldap-server port <i>port_no</i>	Sets the LDAP port number. Enter a number between 1 and 65535. The default is 389. The <b>no</b> command clears this setting.
[no] ldap-server search-time-limit <i>time</i>	Sets the search timeout period (in seconds). Enter a number between 1 and 300. The <b>no</b> command clears this setting.
[no] ldap-server ssl	Enables the Zyxel Device to establish a secure connection to the LDAP server. The <b>no</b> command disables this feature.

### 55.2.3 radius-server Commands

The following table lists the `radius-server` commands you use to set the default RADIUS server.

Table 261 radius-server Commands

COMMAND	DESCRIPTION
<code>show radius-server</code>	Displays the default RADIUS server settings.
<code>[no] radius-server host radius_server auth-port auth_port</code>	Sets the RADIUS server address and service port number. Enter the IP address (in dotted decimal notation) or the domain name of a RADIUS server. The <code>no</code> command clears the settings.
<code>[no] radius-server key secret</code>	Sets a password (up to 15 alphanumeric characters) as the key to be shared between the RADIUS server and the Zyxel Device. The <code>no</code> command clears this setting.
<code>[no] radius-server timeout time</code>	Sets the search timeout period (in seconds). Enter a number between 1 and 300. The <code>no</code> command clears this setting.

### 55.2.4 radius-server Command Example

The following example sets the secret key and timeout period of the default RADIUS server (172.23.10.100) to "87643210" and 80 seconds.

```
Router# configure terminal
Router(config)# radius-server host 172.23.10.100 auth-port 1812
Router(config)# radius-server key 876543210
Router(config)# radius-server timeout 80
Router(config)# show radius-server
host                : 172.23.10.100
authentication port: 1812
key                 : 876543210
timeout             : 80
Router(config)#
```

### 55.2.5 aaa group server ad Commands

The following table lists the `aaa group server ad` commands you use to configure a group of AD servers.

Table 262 aaa group server ad Commands

COMMAND	DESCRIPTION
<code>clear aaa group server ad [group-name]</code>	Deletes all AD server groups or the specified AD server group.  Note: You can NOT delete a server group that is currently in use.
<code>show aaa group server ad group-name</code>	Displays the specified AD server group settings.
<code>[no] aaa group server ad group-name</code>	Sets a descriptive name for an AD server group. Use this command to enter the sub-command mode.  The <code>no</code> command deletes the specified server group.
<code>aaa group server ad rename group-name group-name</code>	Changes the descriptive name for an AD server group.

Table 262 aaa group server ad Commands (continued)

COMMAND	DESCRIPTION
aaa group server ad <i>group-name</i>	Enter the sub-command mode to configure an AD server group.
[no] case-sensitive	Specify whether or not the server checks the username case. Set this to be the same as the server's behavior.
[no] server alternative-cn-identifier <i>uid</i>	Sets the second type of identifier that the users can use to log in if any. For example "name" or "e-mail address". The no command clears this setting.
[no] server basedn <i>basedn</i>	Sets the base DN to point to the AD directory on the AD server group. The no command clears this setting.
[no] server binddn <i>binddn</i>	Sets the user name the Zyxel Device uses to log into the AD server group. The no command clears this setting.
[no] server cn-identifier <i>uid</i>	Sets the user name the Zyxel Device uses to log into the AD server group. The no command clears this setting.
[no] server description <i>description</i>	Sets the descriptive information for the AD server group. You can use up to 60 printable ASCII characters. The no command clears the setting.
[no] server group-attribute <i>group-attribute</i>	Sets the name of the attribute that the Zyxel Device is to check to determine to which group a user belongs. The value for this attribute is called a group identifier; it determines to which group a user belongs. You can add ext-group-user user objects to identify groups based on these group identifier values.  For example you could have an attribute named "memberOf" with values like "sales", "RD", and "management". Then you could also create an ext-group-user user object for each group. One with "sales" as the group identifier, another for "RD" and a third for "management". The no command clears the setting.
[no] server host <i>ad_server</i>	Enter the IP address (in dotted decimal notation) or the domain name of an AD server to add to this group. The no command clears this setting.
[no] server password <i>password</i>	Sets the bind password (up to 15 alphanumeric characters). The no command clears this setting.
[no] server port <i>port_no</i>	Sets the AD port number. Enter a number between 1 and 65535. The default is 389. The no command clears this setting.
[no] server search-time-limit <i>time</i>	Sets the search timeout period (in seconds). Enter a number between 1 and 300. The no command clears this setting and set this to the default setting of 5 seconds.
[no] server ssl	Enables the Zyxel Device to establish a secure connection to the AD server. The no command disables this feature.

## 55.2.6 aaa group server ldap Commands

The following table lists the `aaa group server ldap` commands you use to configure a group of LDAP servers.

Table 263 aaa group server ldap Commands

COMMAND	DESCRIPTION
<code>clear aaa group server ldap</code> <i>[group-name]</i>	Deletes all LDAP server groups or the specified LDAP server group.  Note: You can NOT delete a server group that is currently in use.
<code>show aaa group server ldap</code> <i>group-name</i>	Displays the specified LDAP server group settings.
<code>[no] aaa group server ldap</code> <i>group-name</i>	Sets a descriptive name for an LDAP server group. Use this command to enter the sub-command mode.  The <code>no</code> command deletes the specified server group.
<code>aaa group server ldap rename</code> <i>group-name group-name</i>	Changes the descriptive name for an LDAP server group.
<code>aaa group server ldap</code> <i>group-name</i>	Enter the sub-command mode.
<code>[no] case-sensitive</code>	Specify whether or not the server checks the username case. Set this to be the same as the server's behavior.
<code>[no] server alternative-cn-identifier</code> <i>uid</i>	Sets the second type of identifier that the users can use to log in if any. For example "name" or "e-mail address". The <code>no</code> command clears this setting.
<code>[no] server basedn</code> <i>basedn</i>	Sets the base DN to point to the LDAP directory on the LDAP server group. The <code>no</code> command clears this setting.
<code>[no] server binddn</code> <i>binddn</i>	Sets the user name the Zyxel Device uses to log into the LDAP server group. The <code>no</code> command clears this setting.
<code>[no] server cn-identifier</code> <i>uid</i>	Sets the user name the Zyxel Device uses to log into the LDAP server group. The <code>no</code> command clears this setting.
<code>[no] server description</code> <i>description</i>	Sets the descriptive information for the LDAP server group. You can use up to 60 printable ASCII characters. The <code>no</code> command clears this setting.
<code>[no] server group-attribute</code> <i>group-attribute</i>	Sets the name of the attribute that the Zyxel Device is to check to determine to which group a user belongs. The value for this attribute is called a group identifier; it determines to which group a user belongs. You can add <code>ext-group-user</code> user objects to identify groups based on these group identifier values.  For example you could have an attribute named "memberOf" with values like "sales", "RD", and "management". Then you could also create an <code>ext-group-user</code> user object for each group. One with "sales" as the group identifier, another for "RD" and a third for "management". The <code>no</code> command clears the setting.
<code>[no] server host</code> <i>ldap_server</i>	Enter the IP address (in dotted decimal notation) or the domain name of an LDAP server to add to this group. The <code>no</code> command clears this setting.
<code>[no] server password</code> <i>password</i>	Sets the bind password (up to 15 characters). The <code>no</code> command clears this setting.
<code>[no] server port</code> <i>port_no</i>	Sets the LDAP port number. Enter a number between 1 and 65535. The default is 389. The <code>no</code> command clears this setting.

Table 263 aaa group server ldap Commands (continued)

COMMAND	DESCRIPTION
[no] server search-time-limit <i>time</i>	Sets the search timeout period (in seconds). Enter a number between 1 and 300. The <b>no</b> command clears this setting and set this to the default setting of 5 seconds.
[no] server ssl	Enables the Zyxel Device to establish a secure connection to the LDAP server. The <b>no</b> command disables this feature.

## 55.2.7 aaa group server radius Commands

The following table lists the `aaa group server radius` commands you use to configure a group of RADIUS servers.

Table 264 aaa group server radius Commands

COMMAND	DESCRIPTION
clear aaa group server radius <i>group-name</i>	Deletes all RADIUS server groups or the specified RADIUS server group.  Note: You can NOT delete a server group that is currently in use.
show aaa group server radius <i>group-name</i>	Displays the specified RADIUS server group settings.
[no] aaa group server radius <i>group-name</i>	Sets a descriptive name for the RADIUS server group. The <b>no</b> command deletes the specified server group.
aaa group server radius rename { <i>group-name-old</i> } <i>group-name-new</i>	Sets the server group name.
aaa group server radius <i>group-name</i>	Enter the sub-command mode.
[no] case-sensitive	Specify whether or not the server checks the username case. Set this to be the same as the server's behavior.
[no] server description <i>description</i>	Sets the descriptive information for the RADIUS server group. You can use up to 60 printable ASCII characters. The <b>no</b> command clears the setting.
[no] server group-attribute <1-255>	Sets the value of an attribute that the Zyxel Device is used to determine to which group a user belongs.  This attribute's value is called a group identifier. You can add <b>ext-group-user</b> user objects to identify groups based on different group identifier values.  For example, you could configure attributes 1,10 and 100 and create a <b>ext-group-user</b> user object for each of them. The <b>no</b> command clears the setting.
[no] server host <i>radius_server</i>	Enter the IP address (in dotted decimal notation) or the domain name of a RADIUS server to add to this server group. The <b>no</b> command clears this setting.
[no] server key <i>secret</i>	Sets a password (up to 15 alphanumeric characters) as the key to be shared between the RADIUS server(s) and the Zyxel Device. The <b>no</b> command clears this setting.
[no] server timeout <i>time</i>	Sets the search timeout period (in seconds). Enter a number between 1 and 300. The <b>no</b> command clears this setting and set this to the default setting of 5 seconds.

## 55.2.8 aaa group server Command Example

The following example creates a RADIUS server group with two members and sets the secret key to "12345678" and the timeout to 100 seconds. Then this example also shows how to view the RADIUS group settings.

```
Router# configure terminal
Router(config)# aaa group server radius RADIUSGroup1
Router(group-server-radius)# server host 192.168.1.100 auth-port 1812
Router(group-server-radius)# server host 172.23.22.100 auth-port 1812
Router(group-server-radius)# server key 12345678
Router(group-server-radius)# server timeout 100
Router(group-server-radius)# exit
Router(config)# show aaa group server radius RADIUSGroup1
key                : 12345678
timeout            : 100
description        :
group attribute    : 11

No.  Host Member                                     Auth. Port
=====
1    192.168.1.100                                   1812
2    172.23.22.100                                   1812
```



# CHAPTER 56

## Authentication Objects

This chapter shows you how to select different authentication methods for user authentication using the AAA servers or the internal user database.

### 56.1 Authentication Objects Overview

After you have created the AAA server objects, you can specify the authentication objects (containing the AAA server information) that the Zyxel Device uses to authenticate users (using VPN or managing through HTTP/HTTPS).

### 56.2 aaa authentication Commands

The following table lists the `aaa authentication` commands you use to configure an authentication profile.

Table 265 aaa authentication Commands

COMMAND	DESCRIPTION
<code>aaa authentication rename <i>profile-name-old</i> <i>profile-name-new</i></code>	Changes the profile name.  <i>profile-name</i> : You may use 1-31 alphanumeric characters, underscores( <code>_</code> ), or dashes ( <code>-</code> ), but the first character cannot be a number. This value is case-sensitive.
<code>clear aaa authentication <i>profile-name</i></code>	Deletes all authentication profiles or the specified authentication profile.  Note: You can NOT delete a profile that is currently in use.
<code>show aaa authentication {<i>group-name</i> default}</code>	Displays the specified authentication server profile settings.
<code>[no] aaa authentication <i>profile-name</i></code>	Sets a descriptive name for the authentication profile. The <code>no</code> command deletes a profile.
<code>aaa authentication default <i>member1</i> [<i>member2</i>] [<i>member3</i>] [<i>member4</i>]</code>	Sets the default profile to use the authentication method(s) in the order specified.  <i>member</i> = <code>group ad</code> , <code>group ldap</code> , <code>group radius</code> , or <code>local</code> .  Note: You must specify at least one member for each profile. Each type of member can only be used once in a profile.

Table 265 aaa authentication Commands (continued)

COMMAND	DESCRIPTION
<pre>aaa authentication profile-name member1 [member2] [member3] [member4]</pre>	<p>Sets the profile to use the authentication method(s) in the order specified.</p> <p><i>member</i> = group ad, group ldap, group radius, or local.</p> <p>Note: You must specify at least one member for each profile. Each type of member can only be used once in a profile.</p>
<pre>aaa authentication [no] match-default- group</pre>	<p>Enable this to treat a user successfully authenticated by a remote auth server as a defat-ext-user. If the remote authentication server is LDAP, the default-ext-user account is an ldap-user. If the remote authentication server is AD, the default-ext-user account is an ad-user. If the remote authentication server is RADIUS, the default-ext-user account is a radius-user.</p>

## 56.2.1 aaa authentication Command Example

The following example creates an authentication profile to authentication users using the LDAP server group and then the local user database.

```
Router# configure terminal
Router(config)# aaa authentication LDAPuser group ldap local
Router(config)# show aaa authentication LDAPuser
No. Method
=====
0 ldap
1 local
Router(config)#
```

## 56.3 test aaa Command

The following table lists the test aaa command you use to teat a user account on an authentication server.

Table 266 test aaa Command

COMMAND	DESCRIPTION
<pre>test aaa {server secure- server} {ad ldap} host {hostname ipv4-address} [host {hostname ipv4- address}] port &lt;1..65535&gt; base-dn base-dn-string [bind-dn bind-dn-string password password] login- name-attribute attribute [alternative-login-name- attribute attribute] account account-name</pre>	<p>Tests whether a user account exists on the specified authentication server.</p>

### 56.3.1 Test a User Account Command Example

The following example shows how to test whether a user account named userABC exists on the AD authentication server which uses the following settings:

- IP address: 172.16.50.1
- Port: 389
- Base-dn: DC=Zyxel,DC=com
- Bind-dn: zyxel\engineerABC
- Password: abcdefg
- Login-name-attribute: sAMAccountName

The result shows the account exists on the AD server. Otherwise, the Zyxel Device responds an error.

```
Router> test aaa server ad host 172.16.50.1 port 389 base-dn DC=Zyxel,DC=com
bind-dn zyxel\engineerABC password abcdefg login-name-attribute
sAMAccountName account userABC

dn:: Q049MTIzNzco546L5aOr56uRKsXPVT1XaXRoTWFpbCxEQz1aeVhFTCxEQz1jb20=
objectClass: top
objectClass: person
objectClass: organizationalPerson
objectClass: user
cn:: MTIzNzco546L5aOr56uRKQ==
sn: User
l: 2341100
-----SNIP!-----
```

## 56.4 VPN/Admin Two-Factor Authentication

Two-factor authentication adds an extra layer of security for users logging into the Zyxel Device. When two-factor authentication is enabled, a user has to first enter their username and password, and then click on a temporary link or enter a one-time password when logging in.

You can enable two-factor authentication for users who are logging into the Zyxel Device to create a VPN tunnel (VPN access), and for administrator and limited admin users who are logging into the Web Configurator or CLI (admin access) to configure the Zyxel Device.

Note: You can also configure two-factor authentication for non-VPN and non-admin users in web authentication. For details, see [Section 31.1 on page 243](#).

Note: The admin two-factor authentication settings override the web authentication two-factor authentication settings if both are configured.

### 56.4.1 Two-Factor Authentication Methods

The following tables lists the methods for two-factor authentication.

Table 267 Two Factor Authentication Methods

ACCESS TYPE	TWO-FACTOR AUTHENTICATION METHOD	FACTOR 2 PASSWORD
VPN	SMS	Link
VPN	Email	Link
Admin	SMS	Code

Table 267 Two Factor Authentication Methods (continued)

ACCESS TYPE	TWO-FACTOR AUTHENTICATION METHOD	FACTOR 2 PASSWORD
Admin	Email	Code
Admin	Google Authenticator app	Code

## 56.4.2 Two-Factor Authentication with SMS/Email

This section introduces how SMS/email two-factor authentication works.

**Figure 36** SMS/Email Two-Factor Authentication

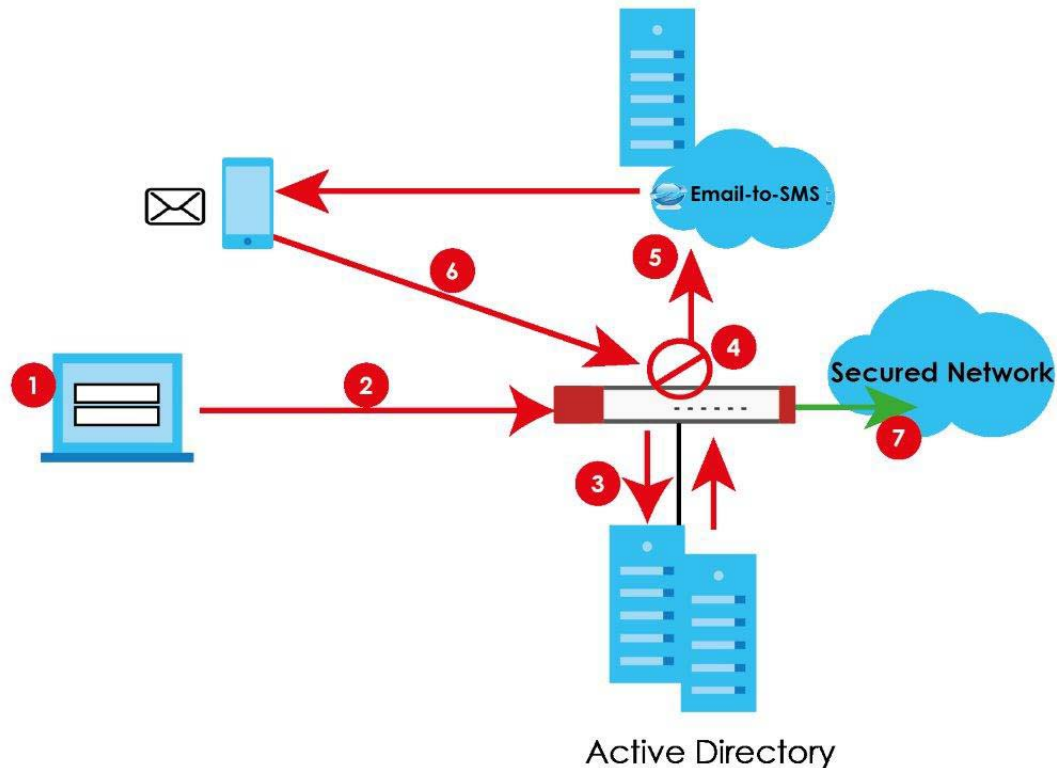

### VPN Access

- 1 A user runs a VPN client and enters their VPN user name and password.
- 2 A VPN connection is created from the VPN client device to the Zyxel Device.
- 3 The Zyxel Device requests the user's user-name, password and mobile phone number or email address from the Active Directory, RADIUS server or local Zyxel Device database in order to authenticate this user's use of the VPN tunnel (factor 1). If they are not found, then the Zyxel Device terminates the VPN connection.
- 4 If all correct credentials are found, then the Zyxel Device requests the Email-to-SMS Provider to send an authorization SMS, or the Zyxel Device sends an email to the client requesting VPN access (factor 2).
- 5 The client must open the authorization link sent via SMS or email within a user-specified time period (Valid Time).

- 6 If the authorization is correct and received on time, the client can access the secured network through the VPN tunnel.

### **Admin Access (Web Configurator, SSH, Telnet)**

- 1 An admin user connects to the Zyxel Device through the Web Configurator, SSH, or Telnet.
- 2 The Zyxel Device requests the admin user's user-name, password and mobile phone number or email address from the Active Directory, RADIUS server or local Zyxel Device database in order to authenticate this admin user.
- 3 If all correct credentials are found, then the Zyxel Device requests the Email-to-SMS Provider to send an authorization SMS, or the Zyxel Device sends an email to the client requesting VPN access (factor 2).
- 4 The client must enter the code sent via SMS or email within a user-specified time period (Valid Time).
- 5 If the authorization is correct and received on time, the admin user can log into Zyxel Device.

### **56.4.3 SMS/Email Configuration**

Before enabling SMS/email Two-Factor Authentication, you must:

- Set up the user's user-name, password and email address or mobile number in the Active Directory, RADIUS server or local Zyxel Device database
- Configure the VPN tunnel for this user on the Zyxel Device
- Have an account with an Email-to-SMS Provider to be able to send SMS authorization requests
- Enable HTTP and/or HTTPS
- Enable SSH and/or Telnet
- Configure SMS and a mail server.

Two-Factor authentication may fail if one of the above is not configured or one of the below occurred.

- The user did not receive the authorization SMS or email. Check if the mobile telephone number or email address of the user in the Active Directory, RADIUS Server or local Zyxel Device database is configured correctly.
- Email-to-SMS Provider Authentication failed and no SMS was sent. Check that SMS is enabled on the Zyxel Device and credentials are correct.
- Mail server authentication failed. Check if the mail server settings are correct on the Zyxel Device.
- The authorization timed out. Extend the Valid Time.

### **56.4.4 Two-Factor Authentication with Google Authenticator**

This section introduces how Google Authenticator two-factor authentication works.

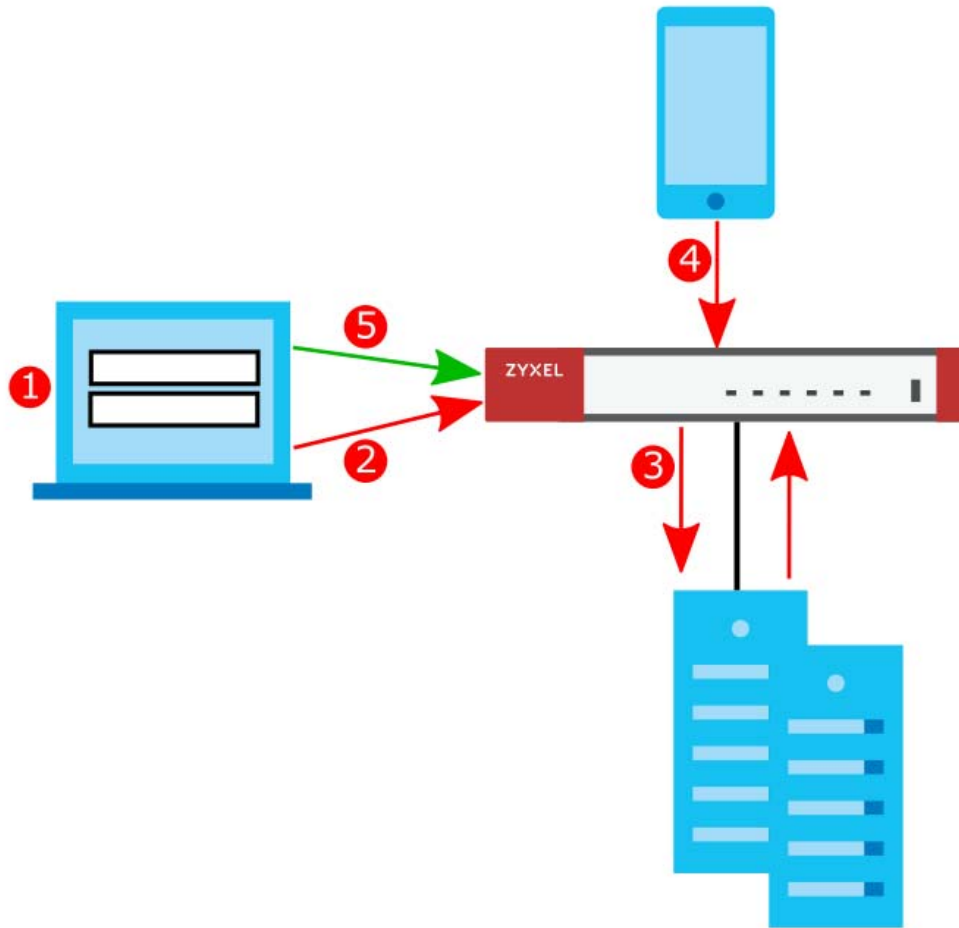
**Figure 37** Google Authenticator Two-Factor Authentication

### Admin Access (Web Configurator, SSH, Telnet)

- 1** An admin user connects to the Zyxel Device through the Web Configurator, SSH, or Telnet.
- 2** The Zyxel Device requests the admin user's username and password.
- 3** The Zyxel Device authenticates the admin user's username and password using an Active Directory server, a RADIUS server, or a local Zyxel Device database. If this authentication is successful, the Zyxel Device requests the admin user's Google Authenticator code.
- 4** The admin user enters the code displayed in the Google Authenticator app.
- 5** If the Google Authenticator code is correct, the admin user can log into the Zyxel Device.

## 56.5 Two-Factor Authentication Commands

### 56.5.1 Two-Factor Authentication VPN Access

Use the following commands to configure which users and services require two-factor authentication for VPN access.

Table 268 two-factor Authentication Commands: VPN Access

COMMAND	DESCRIPTION
[no] two-factor-auth activate	Enables two-factor authentication to access a secured network behind the Zyxel Device via a VPN tunnel. The <code>no</code> command disables double-layer security.
[no] two-factor-auth valid-time <1..15>	Sets the maximum time (1-15 minutes) that the VPN client user must click or tap the authorization link in the SMS or email in order to get authorization for the VPN connection. The <code>no</code> command sets the maximum time to 3.
two-factor-auth server interface <i>interface_name</i>	Sets the Zyxel Device WAN interface to be used for two-factor authentication. This is part of the link that the VPN client user will receive in the SMS or email. The VPN client user must be able to access the link.  <i>interface_name</i> : See <a href="#">Section 16.2 on page 115</a> for information about interface names.
two-factor-auth server user-defined { <i>ipv4</i>   <i>domain_name</i> }	Sets the WAN IPv4 address or domain name to be used for two-factor authentication. This is part of the link that the VPN client user will receive in the SMS or email. The VPN client user must be able to access the link.  <i>domain_name</i> : This name can be up to 254 alphanumeric characters long. Spaces are not allowed, but dashes "-" and underscores "_" are accepted.  <i>ipv4</i> : IPv4 address <W.X.Y.Z>
two-factor-auth sms message { <i>message_quoted</i>   <i>message</i> }	Sets the SMS message the VPN client user will receive by SMS for two-factor authentication. Use <user>, <host>, <url>, and <time> (in angular brackets) as variables to display dynamic information. The message must contain the <url> variable.  <i>message_quoted</i> : Put the actual message in quotes.  <i>message</i> : Put the name of a file with the message. The message file must be named '2FA-msg.txt' and be in UTF-8 format.
two-factor-auth message { <i>message_quoted</i>   <i>message</i> }	Sets the SMS message the VPN client user will receive by email for two-factor authentication. Use <user>, <host>, <url>, and <time> (in angular brackets) as variables to display dynamic information. The message must contain the <url> variable.  <i>message_quoted</i> : Put the actual message in quotes.  <i>message</i> : Put the name of a file with the message. The message file must be named '2FA-msg.txt' and be in UTF-8 format.
two-factor-auth message-type {default   file}	Sets which message to be used for two-factor authentication.  default: a message edited using the <code>two-factor-auth message</code> command or via the web configurator.  file: a message file uploaded from your computer using the <code>two-factor-auth message</code> command or via the web configurator.

Table 268 two-factor Authentication Commands: VPN Access (continued)

COMMAND	DESCRIPTION
<code>[no] two-factor-auth deliver-method {sms   email}</code>	<p>Sets the method to be used for two-factor authentication delivery to the VPN client user. The <code>no</code> command removes the method.</p> <ul style="list-style-type: none"> <li><code>sms</code>: must contain a valid mobile telephone number. A valid mobile telephone number can be up to 20 characters in length, including the numbers 1-9 and the following characters in the square brackets [<code>*#()-</code>].</li> <li><code>email</code>: must contain a valid email address. A valid email address must contain the <code>@</code> character. For example, this is a valid email address: <code>abc@example.com</code>.</li> </ul>
<code>[no] two-factor-auth service {sslvpn ipsec l2tp}</code>	<p>Sets which kinds of VPN tunnels require Two-Factor Authentication. You should have configured the VPN tunnel first. The <code>no</code> command removes the VPN tunnel type.</p> <ul style="list-style-type: none"> <li>SSL VPN Access</li> <li>IPSec VPN Access</li> <li>L2TP/IPSec VPN Access</li> </ul>
<code>[no] two-factor-auth user username</code>	<p>Sets the users or user groups that require two-factor authentication. The user or user group accounts should be already created. The <code>no</code> command removes the users or user groups that require two-factor authentication.</p>
<code>two-factor-auth allow-access-url-thru-tunnel [activate   deactivate]</code>	<p>Allows access to the link that the user will receive in the SMS or email. The user must be able to access the link and the Zyxel Device must have http/https enabled with a WAN interface/IP address/domain-name defined. The <code>no</code> command removes access to the link.</p>
<code>[no] two-factor-auth http activate</code>	<p>Enables the VPN client user to access the two-factor authorization page using the http protocol.</p> <p>Use the <code>no</code> command to require the VPN client user to access the two-factor authorization page using the https protocol.</p>
<code>two-factor-auth http port &lt;1...65535&gt;</code>	<p>Sets a new port between 1 to 65535 that is not in use by other services.</p> <p>Use this port for two-factor authentication of VPN clients to access the network behind the Zyxel Device. VPN clients do not need to change the port number on their devices, because the link to access the network behind the Zyxel Device will contain the new port number.</p> <p>For example, if you change this to port 8008 and the link is using a.b.c.d, the VPN clients will see this link in their email or SMS to access the network behind the Zyxel Device: <code>https://a.b.c.d:8008</code>.</p>
<code>show two-factor-auth</code>	<p>Displays current two-factor command settings for the VPN connection.</p>



## 56.5.2 VPN Access Two-Factor Command Example

The following example shows current two-factor command settings.

```
Router# show two-factor-auth
Activate : yes
Valid Time : 3
Auth Server Type : interface
Auth Server : wan1
Send Http Link : no
Allow Access URL thru Tunnel : enable
Deliver-Method-SMS : enable
Deliver-Method-Email : enable
Message-Type : default
Message : <user>. You have initiated a VPN connection to a secured network
behind the <host>. Please click or tap the following link within <time>
minutes to get authorization for the VPN connection.
Service : ipsec,sslvpn,l2tp
Allowed User : any,
Router#
```

## 56.5.3 Admin Access

Use the following commands to configure whether **Web**, **SSH**, and **TELNET** require two-factor authentication for the admin user.

Table 269 two-factor Authentication Commands

COMMAND	DESCRIPTION
[no] two-factor-auth admin-access activate	Enables two-factor authentication to access a secured network behind the Zyxel Device via the Web Configurator, SSH, or Telnet as the admin user. The <b>no</b> command disables double-layer security.
two-factor-auth admin-access auth-method {google-auth pin-code}	Sets the default two-factor authentication method for new admin accounts to either Google Authenticator or SMS/email).
[no] two-factor-auth admin-access valid-time <1..5>	Sets the maximum time (1-5 minutes) that the admin user must enter the code from the SMS or email in order to get authorization for logins via the Web Configurator, SSH, or Telnet.  The <b>no</b> command sets the maximum time to 3.
[no] two-factor-auth admin-access deliver-method {sms email}	Sets the method to be used for two-factor authentication pin code delivery to the admin user. The <b>no</b> command removes the method. <ul style="list-style-type: none"><li>• <b>sms</b>: must contain a valid mobile telephone number. A valid mobile telephone number can be up to 20 characters in length, including the numbers 1-9 and the following characters in the square brackets [+*#()-].</li><li>• <b>email</b>: must contain a valid email address. A valid email address must contain the @ character. For example, this is a valid email address: abc@example.com.</li></ul>
[no] two-factor-auth admin-access user <i>username</i>	Uses this command and the admin user requires two-factor authentication for admin access.  The <b>no</b> command means the admin user does not require two-factor authentication.

Table 269 two-factor Authentication Commands (continued)

COMMAND	DESCRIPTION
<code>[no] two-factor-auth admin-access service {ssh telnet web}</code>	Sets which services require Two-Factor Authentication for the admin user. The <code>no</code> command removes disables two-Factor Authentication for the specified access type. <ul style="list-style-type: none"> <li>• SSH</li> <li>• Telnet</li> <li>• Web</li> </ul>
<code>username username 2fa-auth-method {default google-auth pin-code}</code>	Sets the two-factor authentication method for the user to either Google Authenticator or SMS/email.  Default sets the authentication method to the default method set by the command <code>two-factor-auth admin-access auth-method</code> .
<code>username username [no] google-auth</code>	Enables two-factor authentication by Google Authenticator for the user account. The Zyxel Device creates a Google Authenticator QR code, and a set of backup codes for the account.  The <code>no</code> command disables two-factor authentication by Google Authenticator for the user account, and also deletes the account's Google Authenticator QR code, secret key file, and backup codes.
<code>username username google-auth verify-code &lt;verification code&gt;</code>	Verifies whether the code currently displayed in the Google Authenticator app is correct or not.  The Zyxel Device also creates a secret key file if one does not already exist.
<code>username username google-auth backup-code create</code>	Generates five new Google Authenticator backup codes. All previously generated backup codes become invalid.  You can use Google Authenticator backup codes to log into the Zyxel Device if you are unable to access the Google Authenticator app.
<code>username username [no] {email1-verify email2-verify}</code>	Verifies that the specified email address for the specified user name is valid. Use the <code>no</code> command and the specified email address for the specified user name will be invalid.
<code>username username [no] phone-verify</code>	Verifies that the specified mobile telephone number for the specified user name is valid. Use the <code>no</code> command and the specified mobile telephone number for the specified user name will be invalid.
<code>show two-factor-auth admin-access</code>	Displays current two-factor command settings for logins via the Web Configurator, SSH, or Telnet.
<code>show username username google-auth qrcode</code>	Displays the Google Authenticator QR code for this account.  You can link this user account with Google Authenticator by pressing <b>Enter Provided Key</b> in the Google Authenticator app.
<code>show username username google-auth backup-code</code>	Displays the Google Authenticator backup codes for this user account.  You can use Google Authenticator backup codes to log into the Zyxel Device if you are unable to access the Google Authenticator app.
<code>show two-factor-auth admin-access</code>	Displays the default two-factor authentication method for new admin accounts

## 56.5.4 Admin Access Two-Factor Command Example

The following example shows how to set up two-factor authentication for an admin user.

Note: You need to add the QRCode key manually to the Google Authenticator app after running `.show username <USERNAME> google-auth qrcode`.

```
Router(config)# two-factor-auth admin-access activate
Router(config)# two-factor-auth admin-access user admin
Router(config)# username admin google-auth
Router(config)# show username admin google-auth qrcode
qrcode-url# otpauth://totp/
admin?secret=XXXXXXXXXXXXXXXXXXXXXXXXXXXX&issuer=atp100w
Router(config)# username admin google-auth verify-code 123456
Verify: Success
```

# CHAPTER 57

## Authentication Server

This chapter shows you how to configure the Zyxel Device as an authentication server for access points.

### 57.1 Authentication Server Overview

The Zyxel Device can also work as a RADIUS server to exchange messages with other APs for user authentication and authorization.

### 57.2 Authentication Server Commands

The following table lists the authentication server commands you use to configure the Zyxel Device's built-in authentication server settings.

Table 270 Command Summary: Authentication Server

COMMAND	DESCRIPTION
[no] <code>auth-server activate</code>	Sets the Zyxel Device to act as an authentication server for other RADIUS clients, such as APs. The <code>no</code> command sets the Zyxel Device to not act as an authentication server for other APs.
<code>auth-server authentication</code> <code>auth_method</code>	Specifies an authentication method used by the authentication server.
<code>no auth-server authentication</code>	Resets the authentication method used by the authentication server to the factory default ( <code>default</code> ).
[no] <code>auth-server cert</code> <code>certificate_name</code>	Specifies a certificate used by the authentication server (Zyxel Device). The <code>no</code> command resets the certificate used by the authentication server to the factory default ( <code>default</code> ).  <i>certificate_name</i> : The name of the certificate. You can use up to 31 alphanumeric and ;'~!@#\$\$%^&()_+[]{}',.- characters.
[no] <code>auth-server trusted-client</code> <code>profile_name</code>	Creates a trusted RADIUS client profile. The <code>no</code> command deletes the specified profile.  <i>profile-name</i> : You may use 1-31 alphanumeric characters, underscores (_), or dashes (-), but the first character cannot be a number. This value is case-sensitive.
[no] <code>activate</code>	Enables the client profile. The <code>no</code> command disables the profile.
[no] <code>ip address ip</code> <code>subnet_mask</code>	Sets the client's IP address and subnet mask. The <code>no</code> command clears this setting.
[no] <code>secret secret</code>	Sets a password as the key to be shared between the Zyxel Device and the client. The <code>no</code> command clears this setting.

Table 270 Command Summary: Authentication Server (continued)

COMMAND	DESCRIPTION
[no] description <i>description</i>	Sets the description for the profile. The <code>no</code> command clears this setting.  <i>description</i> : You can use alphanumeric and ( ) + / : = ? ! * # @ \$ _ % - characters, and it can be up to 60 characters long.
show auth-server status	Displays the Zyxel Device's authentication server settings.
show auth-server trusted-client	Displays all RADIUS client profile settings.
show auth-server trusted-client <i>profile_name</i>	Displays the specified RADIUS client profile settings.

## 57.2.1 Authentication Server Command Examples

The following example shows you how to enable the authentication server feature on the Zyxel Device and sets a trusted RADIUS client profile. This example also shows you the authentication server and client profile settings.

```
Router# configure terminal
Router(config)# auth-server activate
Router(config)# auth-server trusted-client AP-1
Router(config-trusted-client-AP-1)# activate
Router(config-trusted-client-AP-1)# ip address 10.10.1.2 255.255.255.0
Router(config-trusted-client-AP-1)# secret 12345678
Router(config-trusted-client-AP-1)# exit
Router(config)# show auth-server status
activation: yes
authentication method: default
certificate: default
Router(config)# show auth-server trusted-client AP-1
Client: AP-1
  Activation: yes
  Description:
  IP: 10.10.1.2
  Netmask: 255.255.255.0
  Secret: VQEq907jWB8=
Router(config)#
```

# CHAPTER 58

## Certificates

This chapter explains how to use the **Certificates**.

### 58.1 Certificates Overview

The Zyxel Device can use certificates (also called digital IDs) to authenticate users. Certificates are based on public-private key pairs. A certificate contains the certificate owner's identity and public key. Certificates provide a way to exchange public keys for use in authentication.

A Certification Authority (CA) issues certificates and guarantees the identity of each certificate owner. There are commercial certification authorities like CyberTrust or VeriSign and government certification authorities. You can use the Zyxel Device to generate certification requests that contain identifying information and public keys and then send the certification requests to a certification authority.

### 58.2 Certificate Commands

This section describes the commands for configuring certificates.

### 58.3 Certificates Commands Input Values

The following table explains the values you can input with the `certificate` commands.

Table 271 Certificates Commands Input Values

LABEL	DESCRIPTION
<code>certificate_name</code>	The name of a certificate. You can use up to 31 alphanumeric and ;'-!@#\$\$%^&()_+[]{}',.- characters.
<code>cn_ipv4_address</code>	A common name IP version 4 address identifies the certificate's owner.
<code>cn_ipv6_address</code>	A common name IP version 6 address identifies the certificate's owner.
<code>cn_domain_name</code>	A common name domain name identifies the certificate's owner. The domain name is for identification purposes only and can be any string. The domain name can be up to 255 characters. You can use alphanumeric characters, the hyphen and periods.
<code>cn_email</code>	A common name e-mail address identifies the certificate's owner. The e-mail address is for identification purposes only and can be any string. The e-mail address can be up to 63 characters. You can use alphanumeric characters, the hyphen, the @ symbol, periods and the underscore.

Table 271 Certificates Commands Input Values (continued)

LABEL	DESCRIPTION
<i>organizational_unit</i>	Identifies the organizational unit or department to which the certificate owner belongs. You can use up to 31 characters. You can use alphanumeric characters, hyphen (-) and underscore (_).
<i>organization</i>	Identifies the company or group to which the certificate owner belongs. You can use up to 31 characters. You can use alphanumeric characters, the hyphen and the underscore.
<i>country</i>	A two-letter country code, which identifies the nation where the certificate owner is located. For example US, UK, ES, FR.
<i>key_type</i>	<p>Sets the certificate's encryption algorithm and signature hash algorithm.</p> <p>Encryption algorithms:</p> <ul style="list-style-type: none"> <li>• <b>RSA</b>: Rivest, Shamir and Adleman public-key algorithm.</li> <li>• <b>DSA</b>: Digital Signature Algorithm public-key algorithm.</li> <li>• <b>ECDSA</b>: Elliptic Curve Digital Signature Algorithm.</li> </ul> <p>Signature hash algorithms:</p> <ul style="list-style-type: none"> <li>• SHA256</li> <li>• SHA384</li> <li>• SHA512</li> </ul> <p>If you set an encryption algorithm without specifying a signature hash algorithm (for example, <i>key_type rsa</i>), then .</p> <p>Note: RSA and SHA256 are less secure but more compatible with different clients and applications. ECDSA and SHA512 are the more secure but less compatible.</p>
<i>key_length</i>	<p>Specify the length of the key, in bits. Allowed values:.</p> <ul style="list-style-type: none"> <li>• ECDSA: 256, 384</li> <li>• RSA/DSA: 512, 768, 1024, 1536, 2048, 4096</li> </ul> <p>Typically, the longer the key, the more secure it is. A longer key also uses more PKI storage space. ECDSA keys are significant shorter than RSA and DSA keys, while offering equal or higher security.</p>
<i>password</i>	When you have the Zyxel Device enroll for a certificate immediately online, the certification authority may want you to include a key (password) to identify your certification request. Use up to 31 of the following characters. a-zA-Z0-9; `~!@#\$\$%^&*()_+{}';./:<>=-
<i>ca_name</i>	When you have the Zyxel Device enroll for a certificate immediately online, you must have the certification authority's certificate already imported as a trusted certificate. Specify the name of the certification authority's certificate. It can be up to 31 alphanumeric and ;'~!@#\$\$%^&*()_+[]{}';./:=- characters.
<i>url</i>	When you have the Zyxel Device enroll for a certificate immediately online, enter the IP address (or URL) of the certification authority server. You can use up to 511 of the following characters. a-zA-Z0-9'()+,./:~!*"#\$_%-
<i>town</i>	<p>Identifies the city or town in which the certificate owner is located. You can use up to 31 characters. You can use alphanumeric characters, the hyphen and the underscore.</p> <p>You can add multiple words by enclosing them in double quotes, for example "New York".</p>
<i>state</i>	<p>Identifies the state, province, or region in which the certificate owner is located. You can use up to 31 characters. You can use alphanumeric characters, the hyphen and the underscore.</p> <p>You can add multiple words by enclosing them in double quotes, for example "New Mexico".</p>

Table 271 Certificates Commands Input Values (continued)

LABEL	DESCRIPTION
<i>user_definition</i>	Not used at the time of writing.
<i>extend_key</i>	<p>Add extended use cases for the certificate.</p> <ul style="list-style-type: none"> <li><b>client:</b> The Zyxel Device generates and stores a request for a client authentication certificate.</li> <li><b>ike:</b> The Zyxel Device generates and stores a request for an IKE Intermediate authentication certificate.</li> <li><b>svr:</b> The Zyxel Device generates and stores a request for a server authentication certificate.</li> <li><b>client-ike, svr-client, svr-ike, svr-client-ike:</b> Enable a combination of <b>client</b>, <b>ike</b>, and <b>svr</b> settings. For example, <b>client-ike</b> generates and stores a request for a client authentication certificate and also an IKE Intermediate authentication certificate.</li> </ul>
<i>lifetimes</i>	<p>Sets how long the certificate is valid, in years. The value must be between 2 and 10.</p> <p>Note: Software such as web browsers might not trust a certificate that has a long lifetime.</p>

## 58.4 Certificates Commands Summary

The following table lists the commands that you can use to display and manage the Zyxel Device's summary list of certificates and certification requests. You can also create certificates or certification requests. Use the `configure terminal` command to enter the configuration mode to be able to use these commands.

Table 272 ca Commands Summary

COMMAND	DESCRIPTION
<pre>ca generate pkcs10 name <i>certificate_name</i> cn- type {ip cn <i>cn_ipv4_address</i>   ipv6 cn <i>cn_ipv6_address</i>   fqdn cn <i>cn_domain_name</i>   mail cn <i>cn_email</i>} [ou <i>organizational_unit</i>] [o <i>organization</i>] [l <i>town</i>] [s <i>state</i>] [c <i>country</i>] [usr-def <i>user_definition</i>] key-type {dsa   dsa- sha256   ecdsa   ecdsa-sha256   ecdsa-sha384   rsa   rsa-sha256   rsa-sha512} key-len <i>key_length</i> [extend-key <i>extend_key</i>] year <i>lifetimes</i></pre>	<p>Generates a PKCS#10 certification signing request (CSR).</p>
<pre>ca generate pkcs12 name <i>name</i> password <i>password</i></pre>	<p>Encrypts the named certificate using the specified password. This CLI command is for debugging purposes only; it is not possible to download the resulting file.</p> <p>To encrypt a certificate and download the resulting CRT file, use the Web Configurator.</p>
<pre>ca generate x509 name <i>certificate_name</i> cn-type {ip cn <i>ipv4</i>   ipv6 cn <i>cn_ipv6_address</i>   fqdn cn <i>cn_domain_name</i>   mail cn <i>cn_email</i>} [ou <i>organizational_unit</i>] [o <i>organization</i>] [l <i>town</i>] [s <i>state</i>] [c <i>country</i>] [usr-def <i>user_definition</i>] key-type {dsa   dsa-sha256   ecdsa   ecdsa- sha256   ecdsa-sha384   rsa   rsa-sha256   rsa- sha512} key-len <i>key_length</i></pre>	<p>Generates a self-signed x509 certificate.</p>



Table 272 ca Commands Summary (continued)

COMMAND	DESCRIPTION
<code>ca rename category {local remote} old_name new_name</code>	Renames a local (my certificates) or remote (trusted certificates) certificate.
<code>ca validation remote_certificate</code>	Enters the sub command mode for validation of certificates signed by the specified remote (trusted) certificates.  Note: At the time of writing, it is not possible to validate ECDSA certificates on the Zyxel Device.
<code>cdp {activate deactivate}</code>	Turns certificate revocation on or off. When it is turned on, the Zyxel Device validates a certificate by getting a Certificate Revocation List (CRL) through HTTP or LDAP (can be configured after activating the LDAP checking option) and online responder (can be configured after activating the OCSP checking option). You also need to configure the OCSP or LDAP server details.
<code>ldap {activate deactivate}</code>	Has the Zyxel Device check (or not check) incoming certificates that are signed by this certificate against a Certificate Revocation List (CRL) on a LDAP (Lightweight Directory Access Protocol) directory server.
<code>ldap ip {ip fqdn} port &lt;1..65535&gt; [id name password password] [deactivate]</code>	Sets the validation configuration for the specified remote (trusted) certificate where the directory server uses LDAP.  <i>ip</i> : Type the IP address (in dotted decimal notation) or the domain name of the directory server. The domain name can use alphanumeric characters, periods and hyphens. Up to 255 characters.  <i>port</i> : Specify the LDAP server port number. You must use the same server port number that the directory server uses. 389 is the default server port number for LDAP.  The Zyxel Device may need to authenticate itself in order to access the CRL directory server. Type the login name (up to 31 characters) from the entity maintaining the server (usually a certification authority). You can use alphanumeric characters, the underscore and the dash.  Type the password (up to 31 characters) from the entity maintaining the CRL directory server (usually a certification authority). You can use the following characters: a-zA-Z0-9;   `~!@#%&^&*( )_+ \{ } ; : , / < > = -
<code>ocsp {activate deactivate}</code>	Has the Zyxel Device check (or not check) incoming certificates that are signed by this certificate against a directory server that uses OCSP (Online Certificate Status Protocol).

Table 272 ca Commands Summary (continued)

COMMAND	DESCRIPTION
<code>ocsp url url [id name password password] [deactivate]</code>	<p>Sets the validation configuration for the specified remote (trusted) certificate where the directory server uses OCSP.</p> <p><i>url</i>: Type the protocol, IP address and pathname of the OCSP server.</p> <p><i>name</i>: The Zyxel Device may need to authenticate itself in order to access the OCSP server. Type the login name (up to 31 characters) from the entity maintaining the server (usually a certification authority). You can use alphanumeric characters, the underscore and the dash.</p> <p><i>password</i>: Type the password (up to 31 characters) from the entity maintaining the OCSP server (usually a certification authority). You can use the following characters: a-zA-Z0-9; `~!@#%&amp;^&amp;*()_+\\{}';./&lt;&gt;=-</p>
<code>no ca category {local remote} certificate_name</code>	Deletes the specified local (my certificates) or remote (trusted certificates) certificate.
<code>no ca validation name</code>	Removes the validation configuration for the specified remote (trusted) certificate.
<code>show ca category {local remote}</code>	Displays a summary of all local (my certificates) or remote (trusted certificates) certificates in readable text.
<code>show ca category {local remote} name certificate_name format {text pem}</code>	<p>Displays information about the local or remote certificate with the specified name.</p> <p>Under format, use <b>text</b> to display the certificate's information in readable text, or <b>pem</b> to display the certificate in PEM (Base-64) encoded format.</p>
<code>show ca category {local remote} name certificate_name certpath</code>	Displays the certificate path of the specified the local or remote certificate.
<code>show ca hierarchy name certificate_name [format all   cn   file]</code>	<p>Displays the hierarchy of certification authorities that validate the certificate, and the certificate itself.</p> <p>Format determines..</p>
<code>show ca validation name name</code>	Displays the validation configuration for the specified remote (trusted) certificate.
<code>show ca spaceusage</code>	Displays the storage space in use by certificates.

## 58.5 Certificates Commands Examples

The following example creates a self-signed X.509 certificate with IP address 10.0.0.58 as the common name. It uses the RSA key type with SHA512. Then it displays the list of local certificates. Finally it deletes the pkcs12request certification request.

```
Router# configure terminal
Router(config)# ca generate x509 name test_x509 cn-type ip cn 10.0.0.58 key-
type rsa key-len 512
Router(config)# show ca category local
certificate: default
  type: SELF
  subject: CN=ZyWALL-1050_Factory_Default_Certificate
  issuer: CN=ZyWALL-1050_Factory_Default_Certificate
  status: VALID
  ID: ZyWALL-1050_Factory_Default_Certificate
  type: EMAIL
  valid from: 2003-01-01 00:38:30
  valid to: 2022-12-27 00:38:30
certificate: test
  type: REQ
  subject: CN=1.1.1.1
  issuer: none
  status: VALID
  ID: 1.1.1.1
  type: IP
  valid from: none
  valid to: none
certificate: pkcs12request
  type: REQ
  subject: CN=1.1.1.2
  issuer: none
  status: VALID
  ID: 1.1.1.2
  type: IP
  valid from: none
  valid to: none
certificate: test_x509
  type: SELF
  subject: CN=10.0.0.58
  issuer: CN=10.0.0.58
  status: VALID
  ID: 10.0.0.58
  type: IP
  valid from: 2006-05-29 10:26:08
  valid to: 2009-05-28 10:26:08
Router(config)# no ca category local pkcs12request
```

# CHAPTER 59

## ISP Accounts

Use ISP accounts to manage Internet Service Provider (ISP) account information for PPPoE, PPTP and cellular interfaces.

### 59.1 ISP Accounts Overview

An ISP account is a profile of settings for Internet access using PPPoE, PPTP, or cellular.

#### 59.1.1 PPPoE and PPTP Account Commands

The following table lists the PPPoE and PPTP ISP account commands.

Table 273 PPPoE and PPTP ISP Account Commands

COMMAND	DESCRIPTION
<code>show account [pppoe <i>profile_name</i>   pptp <i>profile_name</i>]</code>	Displays information about the specified account(s).
<code>[no] account {pppoe   pptp} <i>profile_name</i></code>	Creates a new ISP account with name <i>profile_name</i> if necessary and enters sub-command mode. The <code>no</code> command deletes the specified ISP account.  <i>profile_name</i> : use 1-31 alphanumeric characters, underscores ( <code>_</code> ), or dashes ( <code>-</code> ), but the first character cannot be a number. This value is case-sensitive.
<code>encrypted-password <i>ciphertext</i></code>	Sets a encrypted secret for the specified account.  <i>ciphertext</i> :
<code>[no] user <i>username</i></code>	Sets the username for the specified ISP account. The <code>no</code> command clears the username.  <i>username</i> : You can use alphanumeric, underscores ( <code>_</code> ), dashes ( <code>-</code> ), commas ( <code>,</code> ), and <code>/@\$</code> characters, and it can be up to 64 characters long.
<code>[no] password <i>password</i></code>	Sets the password for the specified ISP account. The <code>no</code> command clears the password.  <i>password</i> : You can use up to 63 printable ASCII characters. Spaces are not allowed.
<code>[no] authentication {chap-pap   chap   pap   mschap   mschap-v2}</code>	Sets the authentication for the specified ISP account. The <code>no</code> command sets the authentication to chap-pap.
<code>[no] compression {yes   no}</code>	Turns compression on or off for the specified ISP account. The <code>no</code> command turns off compression.

Table 273 PPPoE and PPTP ISP Account Commands (continued)

COMMAND	DESCRIPTION
[no] idle <0..360>	Sets the idle timeout for the specified ISP account. The <b>no</b> command sets the idle timeout to zero.
[no] service-name {ip   hostname   service_name}	Sets the service name for the specified PPPoE ISP account. The <b>no</b> command clears the service name.  <i>hostname</i> : You may use up to 63 alphanumeric characters, dashes (-), or periods (.), but the first character cannot be a period.  <i>service_name</i> : You can use up to 63 alphanumeric characters, underscores (_), dashes (-), and @\$./ characters.
[no] server ip	Sets the PPTP server for the specified PPTP ISP account. The <b>no</b> command clears the server name.
[no] encryption {nompppe   mppe-40   mppe-128}	Sets the encryption for the specified PPTP ISP account. The <b>no</b> command sets the encryption to nompppe.
[no] connection-id connection_id	Sets the connection ID for the specified PPTP ISP account. The <b>no</b> command clears the connection ID.  <i>connection_id</i> : You can use up to 31 alphanumeric characters, underscores (_), dashes (-), and colons (:).

## 59.1.2 Cellular Account Commands

The following table lists the cellular ISP account commands.

Table 274 Cellular Account Commands

COMMAND	DESCRIPTION
show account cellular profile_name	Displays information about the specified account.
[no] account cellular profile_name	Creates a new cellular ISP account with name <i>profile_name</i> if necessary and enters sub-command mode. The <b>no</b> command deletes the specified ISP account.  <i>profile_name</i> : the cellular ISP account name format is "cellularx" where "x" is a number. For example, cellular1.
[no] apn access_point_name	Sets the Access Point Name (APN) for the cellular ISP account. The <b>no</b> command clears the APN.  <i>access_point_name</i> : Use up to 63 alphanumeric characters and underscores (_), dashes (-), periods (.), and /@\\$.#.
[no] dial-string isp_dial_string	Sets the dial string for the specified ISP account. The <b>no</b> command clears the dial-string.  <i>isp_dial_string</i> : Use up to 63 alphanumeric characters and underscores (_), dashes (-), periods (.), and /@\\$.#.
[no] user username	Sets the username for the specified ISP account. The <b>no</b> command clears the username.  <i>username</i> : Use up to 64 alphanumeric characters and underscores (_), dashes (-), periods (.), and /@\\$.#.
[no] password password	Sets the password for the specified ISP account. The <b>no</b> command clears the password.  <i>password</i> : Use up to 63 printable ASCII characters. Spaces are not allowed.

Table 274 Cellular Account Commands (continued)

COMMAND	DESCRIPTION
[no] authentication {none   pap   chap}	Sets the authentication for the cellular account. The <code>no</code> command sets the authentication to none.
[no] idle <0..360>	Sets the idle timeout for the cellular account. Zero disables the idle timeout. The <code>no</code> command sets the idle timeout to zero.

# CHAPTER 60

## SSL Application

This chapter describes how to configure SSL application objects for use in SSL VPN.

### 60.1 SSL Application Overview

Configure an SSL application object to specify a service and a corresponding IP address of the server on the local network. You can apply one or more SSL application objects in the **VPN > SSL VPN** screen for a user account/user group.

#### 60.1.1 SSL Application Object Commands

This table lists the commands for creating SSL application objects. You must use the `configure terminal` command to enter the configuration mode before you can use these commands.

Table 275 SSL Application Object Commands

COMMAND	DESCRIPTION
<code>show sslvpn application [application_object]</code>	Displays SSL VPN application objects.
<code>[no] sslvpn application application_object</code>	Enters the sub-command mode to create an SSL VPN application object.
<code>server-type {file-sharing   owa   web-server} url URL [entry-point entry_point]</code>	<p>Specify the type of service for this SSL application.</p> <p><b>file-sharing:</b> create a file share application for SSL VPN.</p> <p><b>owa:</b> (Outlook Web Access) to allow users to access e-mails, contacts, calendars via an Microsoft Outlook-like interface using supported web browsers. The Zyxel Device supports one OWA object.</p> <p><b>web-server:</b> to allow access to the specified web site hosted on the local network.</p> <p><b>url:</b> Enter the fully qualified domain name (FQDN) or IP address of the application server. You must enter the "http://" or "https://" prefix. Remote users are restricted to access only files in this directory. For example, if you enter "\remote\" in this field, remote users can only access files in the "remote" directory.</p> <p><b>entry-point:</b> optional. Specify the name of the directory or file on the local server as the home page or home directory on the user screen.</p>

Table 275 SSL Application Object Commands

COMMAND	DESCRIPTION
<pre>server-type file-sharing share-path share-path</pre>	<p>Specifies the IP address, domain name or NetBIOS name (computer name) of the file server and the name of the share to which you want to allow user access. Enter the path in one of the following formats.</p> <p>"\\&lt;IP address&gt;\&lt;share name&gt;"</p> <p>"\\&lt;domain name&gt;\&lt;share name&gt;"</p> <p>"\\&lt;computer name&gt;\&lt;share name&gt;"</p> <p>For example, if you enter "\\my-server\Tmp", this allows remote users to access all files and/or folders in the "Tmp" share on the "my-server" computer.</p>
<pre>server-type rdp server- address server-address [starting- port &lt;1..65535&gt; ending-port &lt;1..65535&gt;] [program-path program-path]</pre>	<p>Creates an SSL application object to allow users to manage LAN computers that have Remote Desktop Protocol remote desktop server software installed.</p> <p>Specify the listening ports of the LAN computer(s) running remote desktop server software. The Zyxel Device uses a port number from this range to send traffic to the LAN computer that is being remotely managed.</p> <p><i>program-path</i>: specify an application to open when a remote user logs into the remote desktop application.</p>
<pre>server-type vnc server- address server-address [starting- port &lt;1..65535&gt; ending-port &lt;1..65535&gt;]</pre>	<p>Creates an SSL application object to allow users to manage LAN computers that have Virtual Network Computing remote desktop server software installed.</p> <p>Specify the listening ports of the LAN computer(s) running remote desktop server software. The Zyxel Device uses a port number from this range to send traffic to the LAN computer that is being remotely managed.</p>
<pre>server-type weblink url url</pre>	<p>Sets this to create a link to a web site you specified that you expect the SSL VPN users to commonly use.</p> <p><i>url</i>: Enter the fully qualified domain name (FQDN) or IP address of the application server. You must enter the "http://" or "https://" prefix. For example, https://1.2.3.4. SSL VPN users are restricted to access only web pages or files in this directory. For example, if you enter "\remote\" in this field, remote users can only access web pages or files in the "remote" directory.</p> <p>If a link contains a file that is not within this domain, then SSL VPN users cannot access it.</p>
<pre>no server-type</pre>	Remove the type of service configuration for this SSL application.
<pre>[no] webpage-encrypt</pre>	Turn on web encrypt to prevent users from saving the web content.



## 60.1.2 SSL Application Command Examples

The following commands create and display a server-type SSL application object named ZW5 for a web server at IP address 192.168.1.12.

```
Router(config)# sslvpn application ZW5
Router(sslvpn application)# server-type web-server url http://192.168.1.12
Router(sslvpn application)# exit
Router(config)# show sslvpn application
SSL Application: ZW5
  Server Type: web-server
  URL: http://192.168.1.12
  Entry Point:
  Encrypted URL: ~aHR0cDovLzE5Mi4xNjguMS4xMi8=/
  Web Page Encryption: yes
  Reference: 1
```

# CHAPTER 61

## DHCPv6 Objects

This chapter describes how to configure and view DHCPv6 request and lease objects.

### 61.1 DHCPv6 Object Commands Summary

The following table identifies the values required for many DHCPv6 object commands. Other input values are discussed with the corresponding commands.

Table 276 DHCPv6 Object Command Input Values

LABEL	DESCRIPTION
<i>dhcp6_profile</i>	The name of a DHCPv6 request object. Use a string of less than 31 characters.
<i>interface_name</i>	The name of the interface. This depends on the Zyxel Device model. For some models, use <i>gex</i> , $x = 1 - N$ , where $N$ equals the highest numbered Ethernet interface for your Zyxel Device model. For other models, use a name such as <i>wan1</i> , <i>wan2</i> , <i>opt</i> , <i>lan1</i> , or <i>dmz</i> .

The following sections list the DHCPv6 object commands.

#### 61.1.1 DHCPv6 Object Commands

This table lists the commands for DHCPv6 objects. Use the `configure terminal` command to enter the configuration mode to be able to use the commands that configure settings.

Table 277 DHCPv6 Object Commands

COMMAND	DESCRIPTION
<code>show ipv6 dhcp6 binding</code>	Displays the server side IPv6/DUID binding lease.
<code>show dhcp6 interface</code>	Displays all DHCPv6 server, client and relay interfaces.
<code>show dhcp6 lease-object [dhcp6_profile]</code>	Displays the specified DHCPv6 lease object or all of them.
<code>show dhcp6 object-binding interface_name</code>	Displays the DHCPv6 object bound to the specified interface.
<code>show dhcp6 request-object [dhcp6_profile]</code>	Displays the specified DHCPv6 request object or all of them.
<code>dhcp6-lease-object dhcp6_profile address ipv6_addr duid duid</code>	Creates or edits the specified DHCP lease object with the specified IPv6 address and DHCP Unique Identifier (DUID).

Table 277 DHCPv6 Object Commands (continued)

COMMAND	DESCRIPTION
<code>dhcp6-lease-object dhcp6_profile prefix-delegation ipv6_addr_prefix duid duid</code>	Creates or edits the specified pre-fix delegation DHCP lease object with the specified IPv6 address prefix and DUID.
<code>dhcp6-lease-object dhcp6_profile address-ipv6_addr ipv6_addr</code>	Creates or edits the specified DHCP lease object address with the specified IPv6 address range.
<code>dhcp6-lease-object dhcp6_profile { sip-server   ntp-server   dns-server } { ipv6_addr   dhcp6_profile }</code>	Creates or edits the specified SIP server, NTP server, or DNS server DHCP lease object with the specified IPv6 address. When you assign a request object, the lease object value will be the request object value retrieved from the DHCPv6 server.
<code>dhcp6-lease-object rename dhcp6_profile dhcp6_profile</code>	Renames the specified DHCPv6 lease object to the specified name.
<code>no dhcp6-lease-object dhcp6_profile</code>	Deletes the specified DHCPv6 lease object.
<code>dhcp6-request-object dhcp6_profile { dns-server   ntp-server   prefix-delegation   sip-server }</code>	Creates or edits the specified SIP server, DNS server, NTP server, prefix-delegation, or SIP server DHCP request object.
<code>dhcp6-request-object rename dhcp6_profile dhcp6_profile</code>	Renames the specified DHCPv6 request object to the specified name.
<code>no dhcp6-request-object dhcp6_profile</code>	Deletes the specified DHCPv6 request object.

### 61.1.2 DHCPv6 Object Command Examples

This example creates and displays a DHCPv6 lease object named "test1" for IPv6 address 2003::1 with DUID 00:01:02:03:04:05:06:07.

```
Router(config)# dhcp6-lease-object test1 address 2003::1 duid
00:01:02:03:04:05:06:07
Router(config)# show dhcp6 lease-object
DHCP6 Lease Object: test1
  Object Type: address
  Object Value: 2003::1
  DUID: 00:01:02:03:04:05:06:07
  Bind Iface:
  REFERENCE: 0
```

This example makes "test1" into a DHCPv6 address lease object for IPv6 addresses 2004::10 to 2004::40.

```
Router(config)# dhcp6-lease-object test1 address- 2004::10 2004::40
Router(config)# show dhcp6 lease-object
DHCP6 Lease Object: test1
  Object Type: address-
  Object Value: 2004::10
  Ext Object Value: 2004::40
  Bind Iface:
  REFERENCE: 0
```

This example creates and displays a DHCPv6 prefix delegation lease object named "pfx" for IPv6 address prefix 2005::/64 and DUID 00:01:02:03:04:05:06:07, then renames it to "pd".

```
Router(config)# dhcp6-lease-object pfx prefix-delegation 2005::/64 duid
00:01:02:03:04:05:06:07
Router(config)# show dhcp6 lease-object pfx
DHCP6 Lease Object: pfx
  Object Type: prefix-delegation
  Object Value: 2005::/64
  DUID: 00:01:02:03:04:05:06:07
  Bind Iface:
  REFERENCE: 0
Router(config)# dhcp6-lease-object rename pfx pd
Router(config)# show dhcp6 lease-object pd
DHCP6 Lease Object: pd
  Object Type: prefix-delegation
  Object Value: 2005::/64
  DUID: 00:01:02:03:04:05:06:07
  Bind Iface:
  REFERENCE: 0
```

This example deletes the "test1" DHCPv6 lease object.

```
Router(config)# no dhcp6-lease-object test1
```

This example creates a DHCPv6 prefix delegation request object named "pfx" and displays its settings.

```
Router(config)# dhcp6-request-object pfx prefix-delegation
Router(config)# show dhcp6 request-object
DHCP6 Request Object: pfx
  Object Type: prefix-delegation
  Object Value: 2089:3::/48
  Bind Iface: ge2
  REFERENCE: 1
```

# CHAPTER 62

## Dynamic Guest Accounts

### 62.1 Dynamic Guest Accounts Overview

Dynamic guest accounts are guest accounts, but are created dynamically and stored in the Zyxel Device's local user database. A dynamic guest account has a dynamically-created user name and password. A dynamic guest account user can access the Zyxel Device's services only within a given period of time and will become invalid after the expiration date/time.

There are three types of dynamic guest accounts depending on how they are created or authenticated: billing-users, ua-users and trial-users.

billing-users are guest account created with the `dynamic-guest generate` command or the guest manager account or an external printer and paid by cash or created and paid via the on-line payment service.

ua-users are users that log in from the user agreement page.

trial-users are free guest accounts that are created with the `dynamic-guest generate-freeuser` command or the Free Time function.

### 62.2 Dynamic-guest Commands

This table lists the `dynamic-guest` commands. You must use the `configure terminal` command to enter the configuration mode before you can use these commands.

Table 278 dynamic-guest Commands

COMMAND	DESCRIPTION
<code>dynamic-guest freeuser user_name</code>	Creates a free dynamic guest account (trial-user) with the specified user name and enters the dynamic-guest sub-command mode to set the password and timeout settings. See <a href="#">Table 279 on page 494</a> for the sub-commands.
<code>dynamic-guest generate</code>	Sets the Zyxel Device to automatically create a dynamic guest account (billing-user) and enters the dynamic-guest sub-command mode to set the password and timeout settings. See <a href="#">Table 279 on page 494</a> for the sub-commands.
<code>dynamic-guest generate-freeuser</code>	Sets the Zyxel Device to automatically create a free dynamic guest account (trial-user) and enters the dynamic-guest sub-command mode to set the password and timeout settings. See <a href="#">Table 279 on page 494</a> for the sub-commands.
<code>dynamic-guest keep-user-logged-in</code>	
<code>[no] dynamic-guest user_name</code>	Creates a dynamic guest account (billing-user) with the specified user name and enters the dynamic-guest sub-command mode to set the password and timeout settings. See <a href="#">Table 279 on page 494</a> for the sub-commands.  The <code>no</code> command removes the specified dynamic-guest account.

Table 278 dynamic-guest Commands (continued)

COMMAND	DESCRIPTION
<code>show dynamic-guest log</code>	Displays all the dynamic guest accounts which are either active or expired.
<code>show dynamic-guest log create-time begin yyyy-mm-dd hh:mm end yyyy-mm-dd hh:mm</code>	Displays all the active and/or expired dynamic guest accounts that were generated within a specified period of time.
<code>show dynamic-guest users</code>	Displays all the active dynamic guest accounts on the Zyxel Device.

## 62.2.1 dynamic-guest Sub-commands

The following table describes the sub-commands for several `dynamic-guest` commands. Note that not all rule commands use all the sub-commands listed here.

Table 279 dynamic-guest Sub-commands

COMMAND	DESCRIPTION
<code>bandwidth {upload   download} &lt;0..1048576&gt; priority &lt;1..7&gt;</code>	Specifies the maximum bandwidth allowed for the user account in kilobits per second and types a number between 1 and 7 to set the priority for the user's traffic. The smaller the number, the higher the priority.  <code>upload</code> refers to the traffic the Zyxel Device sends out from a user. <code>download</code> refers to the traffic the Zyxel Device sends to a user.
<code>[no] bandwidth activate</code>	Turns on bandwidth management for the user account.  The <code>no</code> command disables bandwidth management for the user account.
<code>charge price</code>	Sets the account's price, up to 99999999.99, per time unit.
<code>create-time yyyy-mm-dd hh:mm</code>	Sets the date and time the account is created.
<code>currency {eur   gbp   usd   user-define currency_code}</code>	Sets the currency for the charge, which is displayed in the UI. <ul style="list-style-type: none"> <li>• <code>eur</code>: Euros.</li> <li>• <code>gbp</code>: British pounds</li> <li>• <code>USD</code>: American dollars</li> <li>• <code>user-define</code>: Specify any three-letter currency name</li> </ul>
<code>e-mail email_address</code>	Sets an email address for the guest user.
<code>encrypted-password password</code>	Sets a new password for the dynamic user.
<code>expire-time yyyy-mm-dd hh:mm</code>	Sets the date and time the account becomes invalid.
<code>login-mac mac_address</code>	Sets the MAC address of the guest's device. The guest account can then only log in from this device.
<code>name description</code>	Sets a human-readable description for the dynamic user.
<code>password password</code>	Sets the password for the account.
<code>payment-info {cash   payment-service}</code>	Sets the method of payment for the account.
<code>phone phone_number</code>	Sets the mobile phone number for the account.
<code>printer-ip ip_address</code>	
<code>quota {total   upload   download} megabytes &lt;0..1023&gt;</code>	Sets how much downstream and/or upstream data in Megabytes can be transmitted through the external interface before the account expires. 0 means there is no data limit for the user account.

Table 279 dynamic-guest Sub-commands (continued)

COMMAND	DESCRIPTION
<code>quota {total   upload   download} gigabytes &lt;0..100&gt;</code>	Sets how much downstream and/or upstream data in Gigabytes can be transmitted through the external interface before the account expires. 0 means there is no data limit for the user account.
<code>quota type {total   upload-download}</code>	Sets a limit for the user account. This only applies to user's traffic that is received or transmitted through the external interface.  Note: When the limit is exceeded, the user is not allowed to access the Internet through the Zyxel Device.  <code>total</code> : set a limit on the total traffic in both directions. <code>upload-download</code> : set a limit on the upstream traffic and downstream traffic respectively.
<code>remaining-time &lt;1..25920000&gt;</code>	Sets the amount of Internet access time (in seconds) remaining for the account.
<code>time-period &lt;1..432000&gt;</code>	Sets the total account of time (in minutes) the account can use to access the Internet through the Zyxel Device.
<code>replenish enable</code>	Reloads the quota of a specific dynamic user's account.
<code>serial-number number</code>	

## 62.2.2 Dynamic-guest Command Example

This example shows how to create a dynamic guest account, configure the account related settings and displays the account information.

```

Router# configure terminal
Router(config)# dynamic-guest generate
[dynamic guest] username:gn0ti7, password:ihzun7
Router(config-dynamic-guest)# charge 5
Router(config-dynamic-guest)# expire-time 2013-06-26 14:00
Router(config-dynamic-guest)# payment-info cash
Router(config-dynamic-guest)# phone 0912345678
Router(config-dynamic-guest)# time-period 1440
Router(config-dynamic-guest)# remaining-time 86400
Router(config-dynamic-guest)# create-time 2013-06-25 14:03
Router(config-dynamic-guest)# exit
Router(config)# show dynamic-guest users
No.      Status      Username      Create Time      Expiration Time
      Time Period      Remaining Time      Charge      ayment Info
Phone Num
      User Role
=====
=====
1        Unused      gn0ti7        2013-06-25 14:03      2013-06-26 14:00
      1day 00:00:00      1day 00:00:00      eur 5,00      cash
0912345678
      billing-users
Router(config)#

```

# CHAPTER 63

## System

This chapter provides information on the commands that correspond to what you can configure in the system screens.

### 63.1 System Overview

Use these commands to configure general Zyxel Device information, the system time and the console port connection speed for a terminal emulation program. They also allow you to configure DNS settings and determine which services/protocols can access which Zyxel Device zones (if any) from which computers.

### 63.2 Customizing the WWW Login Page

Use these commands to customize the Web Configurator login screen. You can also customize the page that displays after an access user logs into the Web Configurator to access network services like the Internet. See [Chapter 49 on page 427](#) for more on access user accounts.

The following figures identify the parts you can customize in the login and access pages.

**Figure 38** Login Page Customization

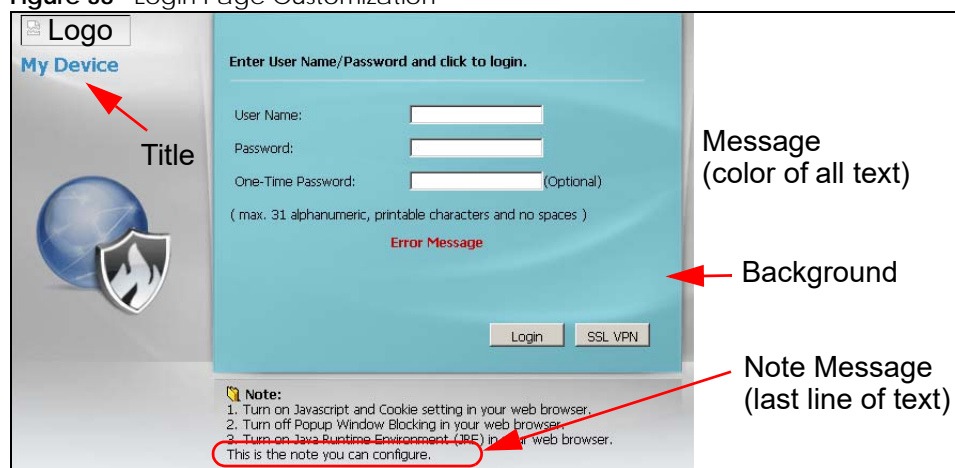
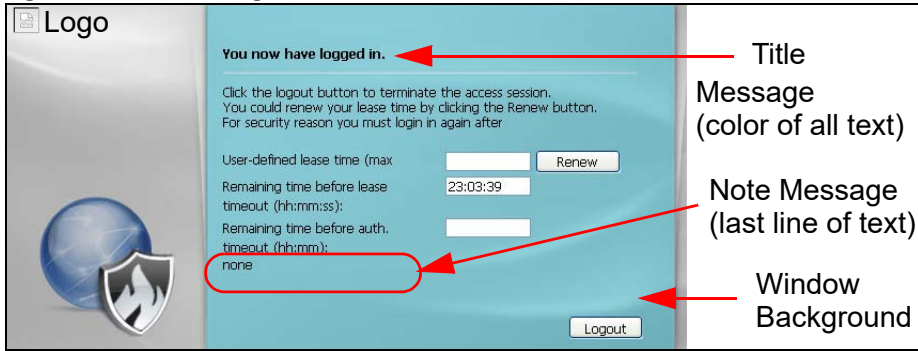



Figure 39 Access Page Customization



You can specify colors in one of the following ways:

- *color-rgb*: Enter red, green, and blue values in parenthesis and separate by commas. For example, use "rgb(0,0,0)" for black.
- *color-name*: Enter the name of the desired color.
- *color-number*: Enter a pound sign (#) followed by the six-digit hexadecimal number that represents the desired color. For example, use "#000000" for black.

The following table describes the commands available for customizing the Web Configurator login screen and the page that displays after an access user logs into the Web Configurator to access network services like the Internet. You must use the `configure terminal` command to enter the configuration mode before you can use these commands.

Table 280 Command Summary: Customization

COMMAND	DESCRIPTION
[no] <code>access-page color-window-background</code>	Sets whether or not the access page uses a colored background.
<code>access-page message-color {color-rgb   color-name   color-number}</code>	Sets the color of the message text on the access page.
[no] <code>access-page message-text message</code>	Sets a note to display below the access page's title. Use up to 64 printable ASCII characters. Spaces are allowed.
<code>access-page title title</code>	Sets the title for the top of the access page. Use up to 64 printable ASCII characters. Spaces are allowed.
<code>access-page window-color {color-rgb   color-name   color-number}</code>	Sets the color of the access page's colored background.
<code>login-page background-color {color-rgb   color-name   color-number}</code>	Sets the color of the login page's background.
[no] <code>login-page color-background</code>	Sets the login page to use a solid colored background.
[no] <code>login-page color-window-background</code>	Sets the login page's window to use a solid colored background.
<code>login-page message-color {color-rgb   color-name   color-number}</code>	Sets the color of the message text on the login page.
[no] <code>login-page message-text % message</code>	Sets a note to display at the bottom of the login screen. Use up to 64 printable ASCII characters. Spaces are allowed.
<code>login-page title title</code>	Sets the title for the top of the login screen. Use up to 64 printable ASCII characters. Spaces are allowed.
<code>login-page title-color {color-rgb   color-name   color-number}</code>	Sets the title text color of the login page.

Table 280 Command Summary: Customization (continued)

COMMAND	DESCRIPTION
login-page window-color { <i>color-rgb</i>   <i>color-name</i>   <i>color-number</i> }	Sets the color of the login page's window border.
logo background-color { <i>color-rgb</i>   <i>color-name</i>   <i>color-number</i> }	Sets the color of the logo banner across the top of the login screen and access page.
show access-page settings	Lists the current access page settings.
show login-page default-title	Lists the factory default title for the login page.
show login-page settings	Lists the current login page settings.
show logo settings	Lists the current logo background (banner) and floor (line below the banner) settings.
show page-customization	Lists whether the Zyxel Device is set to use custom login and access pages or the default ones.

## 63.3 Host Name Commands

The following table describes the commands available for the hostname and domain name. You must use the `configure terminal` command to enter the configuration mode before you can use these commands.

Table 281 Command Summary: Host Name

COMMAND	DESCRIPTION
[no] domainname <i>domain_name</i>	Sets the domain name. The <code>no</code> command removes the domain name.  <i>domain_name</i> : This name can be up to 254 alphanumeric characters long. Spaces are not allowed, but dashes "-" and underscores "_" are accepted.
[no] hostname <i>hostname</i>	Sets a descriptive name to identify your Zyxel Device. The <code>no</code> command removes the host name.
show fqdn	Displays the fully qualified domain name.

## 63.4 Time and Date

For effective scheduling and logging, the Zyxel Device system time must be accurate. The Zyxel Device's Real Time Chip (RTC) keeps track of the time and date. There is also a software mechanism to set the time manually or get the current time and date from an external server.

## 63.4.1 Date/Time Commands

The following table describes the commands available for date and time setup. You must use the `configure terminal` command to enter the configuration mode before you can use these commands.

Table 282 Command Summary: Date/Time

COMMAND	DESCRIPTION
<code>clock date yyyy-mm-dd time hh:mm:ss</code>	Sets the new date in year, month and day format manually and the new time in hour, minute and second format.
<code>[no] clock daylight-saving</code>	Enables daylight savings. The <code>no</code> command disables daylight saving.
<code>[no] clock saving-interval begin {apr aug dec feb jan jul jun mar may nov oct sep} {1 2 3 4 last} {fri mon sat sun thu tue wed} hh:mm end {apr aug dec feb jan jul jun mar may nov oct sep} {1 2 3 4 last} {fri mon sat sun thu tue wed} hh:mm offset</code>	Configures the day and time when daylight saving time starts and ends. The <code>no</code> command removes the day and time when daylight savings time starts and ends.  offset: a number from 1 to 5.5 (by 0.5 increments)
<code>clock time hh:mm:ss</code>	Sets the new time in hour, minute and second format.
<code>[no] clock time-zone {- +hh:mm} [+ -]HH:MM.</code>	Sets your time zone where hh: hour 0-14, mm: minute 0-59). The <code>no</code> command removes time zone settings.
<code>[no] ntp</code>	Saves your date and time and time zone settings and updates the data and time every 24 hours. The <code>no</code> command stops updating the data and time every 24 hours.
<code>[no] ntp server {fqdn w.x.y.z}</code>	Sets the IP address or URL of your NTP time server. The <code>no</code> command removes time server information.
<code>ntp sync</code>	Gets the time and date from an NTP time server.
<code>[no] clock auto-sync-timezone</code>	Allows the Zyxel Device to automatically update its time zone from the cloud server after the set and get commands below are issued.  The <code>no</code> command disables the Zyxel Device from automatically updating its time zone from the cloud server.
<code>[no] clock auto-sync-daylight-saving</code>	Allows the Zyxel Device to automatically update its daylight savings adjusted time from the cloud server after the set and get commands below are issued.  The <code>no</code> command disables the Zyxel Device from automatically updating daylight savings adjusted time from the cloud server.
<code>myzyxel-service get-cloud-timezone</code>	Sends a query to the cloud server to get both time-zone and daylight-savings information for where the Zyxel Device is located. The Zyxel Device keeps the result in a temporary file.
<code>myzyxel-service set-timezone-according-cloud</code>	Applies time-zone and daylight-savings settings according the information received from <code>myzyxel-service get-cloud-timezone</code> and if <code>clock auto-sync-timezone</code> and/or <code>clock auto-sync-daylight-saving</code> were issued. For example, if <code>clock auto-sync-timezone</code> was not issued, then Zyxel Device will not automatically update the time-zone.
<code>show myzyxel-service get-cloud-timezone</code>	Displays the time-zone, daylight savings time start-date, daylight savings time end-date and daylight savings time offset from the cloud server.

Table 282 Command Summary: Date/Time (continued)

COMMAND	DESCRIPTION
<code>show clock date</code>	Displays the current date of your Zyxel Device.
<code>show clock status</code>	Displays your time zone and daylight saving settings.
<code>show clock time</code>	Displays the current time of your Zyxel Device.
<code>show ntp server</code>	Displays time server settings.

## 63.5 Console Port Speed

This section shows you how to set the console port speed when you connect to the Zyxel Device via the console port using a terminal emulation program. The following table describes the console port commands. You must use the `configure terminal` command to enter the configuration mode before you can use these commands.

Table 283 Command Summary: Console Port Speed

COMMAND	DESCRIPTION
<code>[no] console baud <i>baud_rate</i></code>	Sets the speed of the console port. The <code>no</code> command resets the console port speed to the default (115200).  <i>baud_rate</i> : 9600, 19200, 38400, 57600 or 115200.
<code>show console</code>	Displays console port speed.

## 63.6 DNS Overview

DNS (Domain Name System) is for mapping a domain name to its corresponding IP address and vice versa. The DNS server is extremely important because without it, you must know the IP address of a machine before you can access it.

### 63.6.1 Domain Zone Forwarder

A domain zone forwarder contains a DNS server's IP address. The Zyxel Device can query the DNS server to resolve domain zones for features like VPN, DDNS and the time server. A domain zone is a fully qualified domain name without the host. For example, `zyxel.com.tw` is the domain zone for the `www.zyxel.com.tw` fully qualified domain name.

A name query begins at a client computer and is passed to a resolver, a DNS client service, for resolution. The Zyxel Device can be a DNS client service. The Zyxel Device can resolve a DNS query locally using cached Resource Records (RR) obtained from a previous query (and kept for a period of time). If the Zyxel Device does not have the requested information, it can forward the request to DNS servers. This is known as recursion.

The Zyxel Device can ask a DNS server to use recursion to resolve its DNS client requests. If recursion on the Zyxel Device or a DNS server is disabled, they cannot forward DNS requests for resolution.

A Domain Name Server (DNS) amplification attack is a kind of Distributed Denial of Service (DDoS) attack that uses publicly accessible open DNS servers to flood a victim with DNS response traffic. An

open DNS server is a DNS server which is willing to resolve recursive DNS queries from anyone on the Internet.

In a DNS amplification attack, an attacker sends a DNS name lookup request to an open DNS server with the source address spoofed as the victim's address. When the DNS server sends the DNS record response, it is sent to the victim. Attackers can request as much information as possible to maximize the amplification effect.

## 63.6.2 DNS Commands

The following table identifies the values required for many of these commands. Other input values are discussed with the corresponding commands.

Table 284 Input Values for General DNS Commands

LABEL	DESCRIPTION
<i>address_object</i>	The name of the IP address (group) object. You may use 1-31 alphanumeric characters, underscores(_), or dashes (-), but the first character cannot be a number. This value is case-sensitive.
<i>interface_name</i>	The name of the interface.  Ethernet interface: For some Zyxel Device models, use <i>gex</i> , $x = 1 - N$ , where $N$ equals the highest numbered Ethernet interface for your Zyxel Device model.  For other Zyxel Device models, use a name such as <i>wan1</i> , <i>wan2</i> , <i>opt</i> , <i>lan1</i> , or <i>dmz</i> .  virtual interface on top of Ethernet interface: add a colon (:) and the number of the virtual interface. For example: <i>gex.y</i> , $x = 1 - N$ , $y = 1 - 4$  VLAN interface: <i>vlanx</i> , $x = 0 - 4094$  virtual interface on top of VLAN interface: <i>vlanx.y</i> , $x = 0 - 4094$ , $y = 1 - 12$  bridge interface: <i>brx</i> , $x = 0 - N$ , where $N$ depends on the number of bridge interfaces your Zyxel Device model supports.  virtual interface on top of bridge interface: <i>brx.y</i> , $x =$ the number of the bridge interface, $y = 1 - 4$  PPPoE/PPTP interface: <i>pppx</i> , $x = 0 - N$ , where $N$ depends on the number of PPPoE/PPTP interfaces your Zyxel Device model supports.

The following table describes the commands available for DNS. You must use the `configure terminal` command to enter the configuration mode before you can use these commands.

Table 285 Command Summary: DNS

COMMAND	DESCRIPTION
<code>[no] ip dns server a-record fqdn w.x.y.z</code>	Sets an A record that specifies the mapping of a fully qualified domain name (FQDN) to an IP address. The <code>no</code> command deletes an A record.
<code>ip dns server cache-flush</code>	Clears the DNS.
<code>[no] ip dns server mx-record domain_name {w.x.y.z fqdn}</code>	Sets a MX record that specifies a mail server that is responsible for handling the mail for a particular domain. The <code>no</code> command deletes a MX record.
<code>ip dns server rule {&lt;1..32&gt; append insert &lt;1..32&gt;} access-group {ALL address_object} zone {ALL address_object} action {accept deny}</code>	Sets a service control rule for DNS requests.

Table 285 Command Summary: DNS (continued)

COMMAND	DESCRIPTION
<code>ip dns server rule move &lt;1..32&gt; to &lt;1..32&gt;</code>	Changes the number of a service control rule.
<code>[no] ip dns server zone-forwarder {&lt;1..32&gt; append insert &lt;1..32&gt;} {domain_zone_name *} interface interface_name</code>	<p>Sets a domain zone forwarder record that specifies a fully qualified domain name. You can also use a star (*) if all domain zones are served by the specified DNS server(s).</p> <p><i>domain_zone_name</i>: This is a domain zone, not a host. For example, <code>zyxel.com.tw</code> is the domain zone for the <code>www.zyxel.com.tw</code> fully qualified domain name. For example, whenever the Zyxel Device receives needs to resolve a <code>zyxel.com.tw</code> domain name, it can send a query to the recorded name server IP address.</p> <p><i>interface_name</i>: This is the interface through which the ISP provides a DNS server. The interface should be activated and set to be a DHCP client.</p> <p>The <code>no</code> command deletes a zone forwarder record.</p>
<code>ip dns server zone-forwarder {&lt;1..32&gt; append insert &lt;1..32&gt;} {domain_zone_name *} user-defined w.x.y.z {ip_type} [private   interface {interface_name   auto}]</code>	<p>Sets a domain zone forwarder record that specifies a DNS server's IP address.</p> <p><code>private   interface</code>: Use <code>private</code> if the Zyxel Device connects to the DNS server through a VPN tunnel. Otherwise, use the <code>interface</code> command to set the interface through which the Zyxel Device sends DNS queries to a DNS server. The <code>auto</code> means any interface that the Zyxel Device uses to send DNS queries to a DNS server according to the routing rule.</p>
<code>ip dns server zone-forwarder move &lt;1..32&gt; to &lt;1..32&gt;</code>	Changes the index number of a zone forwarder record.
<code>no ip dns server rule &lt;1..32&gt;</code>	Deletes a service control rule.
<code>show ip dns server</code>	Displays all DNS entries.
<code>show ip dns server database</code>	Displays all configured records.
<code>show ip dns server status</code>	Displays whether this service is enabled or not.
<code>show ip dns security-options all</code>	Displays security options configured for the customized and default rules.
<code>ip dns server aaaa-record {FQDN_DNS   FQDN_WILDCARD_DNS} IPv6</code>	<p>An address record contains the mapping of a Fully-Qualified Domain Name (FQDN) to an IP address. Type a Fully-Qualified Domain Name (FQDN) of a server. An FQDN starts with a host name and continues all the way up to the top-level domain name. For example, <code>www.zyxel.com.tw</code> is a fully qualified domain name, where "www" is the host, "zyxel" is the third-level domain, "com" is the second-level domain, and "tw" is the top level domain. Underscores are not allowed.</p> <p>Use "*" as a prefix in the FQDN for a wildcard domain name (for example, *.example.com).</p>
<code>ip dns server cname-record {FQDN_DNS   FQDN_WILDCARD_DNS} {FQDN_DNS}</code>	<p>A Canonical Name Record or CNAME record is a type of resource record in the Domain Name System (DNS) that specifies that the domain name is an alias of another, canonical domain name. Type a Fully-Qualified Domain Name (FQDN) of a server. An FQDN starts with a host name and continues all the way up to the top-level domain name. For example, <code>www.zyxel.com.tw</code> is a fully qualified domain name, where "www" is the host, "zyxel" is the third-level domain, "com" is the second-level domain, and "tw" is the top level domain. Underscores are not allowed.</p> <p>Use "*" as a prefix in the FQDN for a wildcard domain name (for example, *.example.com).</p>

Table 285 Command Summary: DNS (continued)

COMMAND	DESCRIPTION
<code>ip dns security-options {default   1}</code>	Selects to use the default security option or profile '1'. The default allows any address to use <code>additional-from-cache</code> and <code>recursion</code> .
<code>name DNS_OPTIONS_NAME</code>	Names the DNS security options profile.
<code>no address-object-group {any   PROFILE}</code>	Sets the address object to be any or a previously created one. <code>no</code> removes the address object from this DNS security options profile.
<code>no additional-from-cache activate</code>	Activated allows the Zyxel Device to reply to queries with previously cached DNS requests. Deactivated ( <code>no</code> ) does not.
<code>no recursion activate</code>	Activated recursion allows the Zyxel Device to forward queries it can't find in its DNS database. Deactivated ( <code>no</code> ) does not.

### 63.6.3 DNS Command Examples

This command sets an A record that specifies the mapping of a fully qualified domain name (`www.abc.com`) to an IP address (`210.17.2.13`).

```
Router# configure terminal
Router(config)# ip dns server a-record www.abc.com 210.17.2.13
```

This command displays security options configured for the customized and default rules.

```
Router# configure terminal
Router(config)# show ip dns security-options all
security option rule: 1
  Name: Customize
  Address Object: RFC1918_1, RFC1918_2, RFC1918_3
  Additional Info from Cache: allow
  Recursion Query: deny
security option rule: default
  Name: Default
  Address Object: any
  Additional Info from Cache: allow
  Recursion Query: allow
Router(config)#
```

## 63.7 Authentication Server Overview

The Zyxel Device can also work as a RADIUS server to exchange messages with other APs for user authentication and authorization.

## 63.7.1 Authentication Server Commands

The following table lists the authentication server commands you use to configure the Zyxel Device's built-in authentication server settings.

Table 286 Command Summary: Authentication Server

COMMAND	DESCRIPTION
[no] <code>auth-server activate</code>	Sets the Zyxel Device to act as an authentication server for other RADIUS clients, such as APs. The <code>no</code> command sets the Zyxel Device to not act as an authentication server for other APs.
<code>auth-server authentication</code> <code>auth_method</code>	Specifies an authentication method used by the authentication server.
<code>no auth-server authentication</code>	Resets the authentication method used by the authentication server to the factory default ( <code>default</code> ).
[no] <code>auth-server cert</code> <code>certificate_name</code>	Specifies a certificate used by the authentication server (Zyxel Device). The <code>no</code> command resets the certificate used by the authentication server to the factory default ( <code>default</code> ).  <i>certificate_name</i> : The name of the certificate. You can use up to 31 alphanumeric and ;'-!@#%&()_+[]{}',.- characters.
[no] <code>auth-server trusted-client</code> <code>profile_name</code>	Creates a trusted RADIUS client profile. The <code>no</code> command deletes the specified profile.  <i>profile-name</i> : You may use 1-31 alphanumeric characters, underscores(_), or dashes (-), but the first character cannot be a number. This value is case-sensitive.
[no] <code>activate</code>	Enables the client profile. The <code>no</code> command disables the profile.
[no] <code>ip address</code> <i>ip</i> <i>subnet_mask</i>	Sets the client's IP address and subnet mask. The <code>no</code> command clears this setting.
[no] <code>secret</code> <i>secret</i>	Sets a password as the key to be shared between the Zyxel Device and the client. The <code>no</code> command clears this setting.
[no] <code>description</code> <i>description</i>	Sets the description for the profile. The <code>no</code> command clears this setting.  <i>description</i> : You can use alphanumeric and ( ) + / : = ? ! * # @ \$ _ % - characters, and it can be up to 60 characters long.
<code>show auth-server status</code>	Displays the Zyxel Device's authentication server settings.
<code>show auth-server trusted-client</code>	Displays all RADIUS client profile settings.
<code>show auth-server trusted-client</code> <i>profile_name</i>	Displays the specified RADIUS client profile settings.



## 63.7.2 Authentication Server Command Examples

The following example shows you how to enable the authentication server feature on the Zyxel Device and sets a trusted RADIUS client profile. This example also shows you the authentication server and client profile settings.

```
Router# configure terminal
Router(config)# auth-server activate
Router(config)# auth-server trusted-client AP-1
Router(config-trusted-client-AP-1)# activate
Router(config-trusted-client-AP-1)# ip address 10.10.1.2 255.255.255.0
Router(config-trusted-client-AP-1)# secret 12345678
Router(config-trusted-client-AP-1)# exit
Router(config)# show auth-server status
activation: yes
authentication method: default
certificate: default
Router(config)# show auth-server trusted-client AP-1
Client: AP-1
  Activation: yes
  Description:
  IP: 10.10.1.2
  Netmask: 255.255.255.0
  Secret: VQEg907jWB8=
Router(config)#
```

## 63.8 Notification

The notification commands allow you to configure the Zyxel Device to send you event notifications by SMS and email. You can also configure how the Zyxel Device notifies clients that they have accessed a restricted web page.

### 63.8.1 Mail Server Commands

The mail server commands allow you configure a mail server, so you can receive reports and notification emails such as when your password is about to expire.

Table 287 mail-server commands

COMMAND	DESCRIPTION
mail-server	Enters mail-server sub-command mode for configuring e-mail server settings and notification email settings.
[no] mail-from <i>email_address</i>	Sets the email address from which the notification email is sent.
[no] mail-subject append <i>system-name</i>	Determines whether the system name will be appended to the subject of the notification e-mails.
[no] mail-subject append <i>date-time</i>	Determines whether the sending date-time will be appended at subject of the notification e-mails.
schedule hour <0..23> minute <00..59>	Sets the time for sending out the notification e-mails.
show	Displays mail server settings.

Table 287 mail-server commands

COMMAND	DESCRIPTION
[no] smtp-address {ip   hostname}	Sets the SMTP mail server IP address or domain name. The <i>no</i> command removes the mail server IP address or domain name.
[no] smtp-auth activate	Enables or disables ( <i>no</i> command) SMTP authentication.
[no] smtp-auth username username password password	Sets or removes ( <i>no</i> command) the username and password for SMTP authentication.  The password can be up to 63 characters long.
[no] smtp-port <1..65535>	Sets the SMTP port. The <i>no</i> command deletes the setting.
[no] smtp-tls activate	Sets the mail server to use or not use ( <i>no</i> command) Transport Layer Security (TLS) for encrypted communications between the mail server and the Zyxel Device.
[no] smtp-tls authenticate-server	Sets the Zyxel Device to authenticates the mail server in the TLS handshake or not ( <i>no</i> command).
[no] smtp-tls starttls-off	The mail server uses SSL or TLS for encrypted communications between the mail server and the Zyxel Device. This command turns off STARTTLS and uses the TLS protocol. The <i>no</i> command enables the default STARTTLS protocol (SSL) for encrypted communications between the mail server and the Zyxel Device.

## 63.8.2 SMS Service Commands

The Zyxel Device supports Short Message Service (SMS) to send short text messages to mobile devices.

Note: Support for ViaNett on ZyWALL devices will end soon. In firmware version 4.60, all ViaNett configuration settings have been removed from the Web Configurator UI. You can still configure ViaNett using the CLI, but commands related to ViaNett will be removed from the CLI in a future firmware update. We recommend not purchasing any new ViaNett credits.

Table 288 sms-service Commands

COMMAND	DESCRIPTION
sms-service account-send phone phone_number account user_name password password	Specifies the guest account information and the number of mobile device to which you want to send a text message.
[no] sms-service activate	Enables the SMS service on the Zyxel Device.  The <i>no</i> command disabled the SMS service.
sms-service default-country-code country_code	Sets the default country code for the mobile phone number to which you want to send SMS messages.  <i>country_code</i> : one to four digits
sms-service provider vianett	Enters the <i>sms-service-vianett</i> sub-command mode to configure your ViaNett account information.
[no] password password	Sets the password for your ViaNett account.
[no] username e-mail	Sets the user name for your ViaNett account.
sms-service provider-select vianett {vianett email-to-sms}	Selects <i>vianett</i> if you use ViaNett to help forward SMS messages.  Selects <i>email-to-sms</i> if you use another SMS gateway to help forward SMS messages.

Table 288 sms-service Commands (continued)

COMMAND	DESCRIPTION
<code>sms-service provider email-to-sms</code>	Enters email-to-SMS subcommand mode.
<code>provider-domain domain_name</code>	Sets the domain name of your SMS service provider. The domain name can be of up to 252 characters.
<code>auto-append</code>	Adds the domain name of your SMS service provider after the receiver's mobile phone number.
<code>mail-subject mail-subject</code>	Sets the subject line of up to 128 characters for outgoing e-mail from the Zyxel Device.
<code>mail-from user@domainname</code>	Sets the sender's email address of up to 64 characters. This email address needs to be in your SMS provider's allowed sender address list.  If you leave this field blank, the Zyxel Device will use the IP address or domain name configured using the command, <code>smtp-address {ip   hostname}</code> .
<code>mail-to mobile_number@provider_domain</code>	Sets the mobile phone number of up to 80 characters. You can only have one receiver.  Use this variable in brackets [ <code>\$mobile_number\$</code> ], and the Zyxel Device will use the mobile phone number of the user logging in. Use the command, <code>username username phone phone_number</code> , to add a valid mobile telephone number for a user.
<code>no {provider-domain auto-append mail-subject mail-from mail-to}</code>	Clears the settings.
<code>sms-service test-send phone phone_number msg message</code>	Specifies the mobile phone number and message to test whether the Zyxel Device can use SMS to send a text message.
<code>show sms-service</code>	Displays the SMS settings.
<code>show sms-service activation</code>	Displays whether the SMS service is enabled.
<code>show sms-service default-country-code</code>	Displays the default country code for the mobile phone number to which you want to send SMS messages.
<code>show sms-service provider vianett</code>	Displays the ViaNett account information.
<code>show sms-service provider email-to-sms</code>	Displays the settings of the SMS service provider you use.

### 63.8.2.1 SMS Commands Example

The following example enables the SMS service on the Zyxel Device to provide and configures the ViaNett account information. It then displays the SMS settings.

```
Router# configure terminal
Router(config)# sms-service activate
Router(config)# sms-service provider vianett
Router(sms-service-vianett)# username test@example.com
Router(sms-service-vianett)# password 12345
Router(sms-service-vianett)# exit
Router(config)# show sms-service
enable sms service: yes
SMS Country-Code: 0
SMS Provider-Selected: vianett
SMS Service: Vianett
  username: test@example.com
  password: 12345
Router(config)#
```

### 63.8.3 Response Message Commands

When a webpage is blocked by a service such as URL threat filter or content filter, the Zyxel Device displays an HTML block page. The HTML block page informs the user that the page was blocked and why. You can use the response message commands to customize the look of this block page.

Table 289 Commands for Response Message

COMMAND	DESCRIPTION
[no] respmsg url-filter block-page customized activate	Use a custom block page when a page is blocked. The no command tells the Zyxel Device to use the default block page.
respmsg url-filter block-page message-color {<rgb(0,0,255)>   <color name>   <#00FF00>}	Sets the color of the message on the block page. You can specify the color as an RGB value, a Hex value, or as a CSS color name.
respmsg url-filter block-page background-color {<rgb(0,0,255)>   <color name>   <#00FF00>}	Sets the color of the background on the block page. You can specify the color as an RGB value, a Hex value, or as a CSS color name.
respmsg url-filter block-page banner-color {<rgb(0,0,255)>   <color name>   <#00FF00>}	Sets the color of the banner at the bottom of the block page. You can specify the color as an RGB value, a Hex value, or as a CSS color name.
respmsg url-filter block-page banner-message-color {<rgb(0,0,255)>   <color name>   <#00FF00>}	Sets the color of the banner message at the bottom of the block page. You can specify the color as an RGB value, a Hex value, or as a CSS color name.
show respmsg url-filter block-page	Shows the current response message settings.

## 63.9 Language Commands

Use the `language` commands to display what language the web configurator is using or change it. You must use the `configure terminal` command to enter the configuration mode before you can use these commands.

Table 290 Command Summary: Language

COMMAND	DESCRIPTION
<code>language language_name</code>	Specifies the language used in the web configurator screens.  To view a list of supported language names, run the command <code>show language all</code> .
<code>[no] language update auto</code>	Enables (disables) automatic language pack updates at regular times and days.  Note: To save network resources, periodically run the "language update package" command instead of enabling automatic updates.
<code>language update daily &lt;0..23&gt;</code>	Enables automatic language pack updates every day at the time specified.
<code>language update hourly</code>	Enables automatic language pack updates every hour.
<code>language update package</code>	Immediately updates the language pack from the update server.
<code>language update weekly {sun   mon   tue   wed   thu   fri   sat} &lt;0..23&gt;</code>	Enables automatic language pack updates once-a-week at the time and day specified.
<code>show language {setting   all}</code>	<code>setting</code> displays the current display language in the web configurator screens.  <code>all</code> displays the languages available on the Zyxel Device.

## 63.10 IPv6 Commands

Use the `ipv6` commands to enable or disable IPv6 support. You must use the `configure terminal` command to enter the configuration mode before you can use the commands that configure settings.

Table 291 Command Summary: IPv6

COMMAND	DESCRIPTION
<code>[no] ipv6 activate</code>	Enables or disables IPv6 support.
<code>show ipv6 status</code>	Displays whether IPv6 support is enabled or disabled.

## 63.11 ZON Overview

The Zyxel One Network (ZON) utility uses the Zyxel Discovery Protocol (ZDP) for discovering and configuring ZDP-aware Zyxel devices in the same broadcast domain as the computer on which ZON is installed.

The ZON Utility issues requests via ZDP and in response to the query, the Zyxel device responds with basic information including IP address, firmware version, location, system and model name. The information is then displayed in the ZON Utility screen and you can perform tasks like basic configuration of the devices and batch firmware upgrade in it. You can download the ZON Utility at [www.zyxel.com](http://www.zyxel.com) and install it on a computer.

### 63.11.1 LLDP

LLDP is a layer-2 protocol that allows a network device to advertise its identity and capabilities on the local network. It also allows the device to maintain and store information from adjacent devices which are directly connected to the network device. This helps you discover network changes and perform necessary network reconfiguration and management.

### 63.11.2 ZON Commands

The following table describes the commands available for ZON. You must use the `configure terminal` command to enter the configuration mode before you can use these commands.

Table 292 Command Summary: ZON

COMMAND	DESCRIPTION
<code>zon lldp server</code>	Activates LLDP discovery on the Zyxel Device.  This allows you to use Link Layer Discovery Protocol (LLDP) for discovering and configuring LLDP-aware devices in the same broadcast domain as the Zyxel Device that you are logged into using the web configurator.
<code>zon lldp server tx-hold &lt;1..10&gt;</code>	Sets the multiplier used to calculate the TTL (Time To Live) value for the transmitted LLDP packets. The TTL value determines how long the device information can be saved on the neighbors.  LLDP TTL = the multiplier * the LLDP transmission interval
<code>zon lldp server tx-interval &lt;1..600&gt;</code>	Sets the interval (in seconds) at which the Zyxel Device sends a LLDP packet to the neighbor.
<code>zon zdp server</code>	Activates ZDP discovery on the Zyxel Device.
<code>show zon lldp neighbors</code>	Displays the Zyxel Device's neighboring devices via LLDP.
<code>show zon lldp server config</code>	Displays the LLDP settings.
<code>show zon lldp server statistics</code>	Displays the LLDP traffic statistics.
<code>show zon lldp server status</code>	Displays whether LLDP discovery is enabled.
<code>show zon zdp server status</code>	Displays whether ZDP discovery is enabled.

### 63.11.3 ZON Examples

This example enables LLDP discovery and displays whether LLDP discovery is enabled on the Zyxel Device.

```
Router(config)# zon lldp server
Router(config)# zon lldp server status
status: active
Router(config)#
```

## 63.12 Fast Forwarding

Fast Forwarding maximizes the network performance of the Zyxel Device, by enabling a faster packet switching method which uses a trie (prefix tree).

When Fast Forwarding is enabled, essential network services such as NAT, routing, firewall, and VPN work as expected. However, security and logging services such as UTM, web authentication, MAC address binding, BWM, and traffic statistics are bypassed. This means traffic passes through the Zyxel Device unchecked and unlogged.

Note: Enabling fast forward might expose your network to security threats. We recommend enabling fast forwarding temporarily and only when it is needed

### 63.12.1 Fast Forwarding Technical Overview

When switching a packet, a network device examines the packet's destination and then searches its local route cache to determine the output interface and the next hop to the destination. The route cache must be periodically cleared of old and invalid entries, to prevent the cache from consuming too much memory.

Fast Forwarding improves route cache performance by using a trie (prefix tree). A trie is a 256-way binary tree that does not store any data. Instead, each leaf in the tree contains a pointer to data in a separate adjacency table. The routing cache stores destination information in the search tree, and information about how to reach each destination in the adjacency table. Separating the routing cache into two data structures offers several advantages:

- The search tree and adjacency table can be created and recreated separately.
- Modifying entries in the adjacency table does not invalidate entries in the search tree.
- Entries in the adjacency table can point to each other, speeding up recursive routing. Recursive routing is where a device looks up a packet's next hop in the routing cache but does not know how to reach the next hop, requiring another lookup.
- The adjacency table can be updated directly from the device's ARP cache and routing table. This eliminates the need to periodically clear old and invalid entries from the cache.

### 63.12.2 Fast Forwarding Commands

The following table describes the commands available for fast forwarding. You must use the `configure terminal` command to enter the configuration mode before you can use these commands.

Table 293 Command Summary: Fast Forwarding

COMMAND	DESCRIPTION
<code>fast forwarding {activate / deactivate}</code>	Enables or disables fast forwarding on the Zyxel Device.
<code>show fast forwarding status</code>	Displays whether fast forwarding is currently enabled.

# CHAPTER 64

# System Remote Management

This chapter shows you how to determine which services/protocols can access which Zyxel Device zones (if any) from which computers.

Note: To access the Zyxel Device from a specified computer using a service, make sure no service control rules or to-Zyxel Device firewall rules block that traffic.

## 64.1 Remote Management Overview

You may manage your Zyxel Device from a remote location via:

- Internet (WAN only)
- LAN only
- ALL (LAN&WAN&DMZ)
- DMZ only

To disable remote management of a service, deselect **Enable** in the corresponding service screen.

### 64.1.1 Remote Management Limitations

Remote management will not work when:

- 1 You have disabled that service in the corresponding screen.
- 2 The accepted IP address in the **Service Control** table does not match the client IP address. If it does not match, the Zyxel Device will disconnect the session immediately.
- 3 There is a firewall rule that blocks it.

### 64.1.2 System Timeout

There is a lease timeout for administrators. The Zyxel Device automatically logs you out if the management session remains idle for longer than this timeout period. The management session does not time out when a statistics screen is polling.

Each user is also forced to log in the Zyxel Device for authentication again when the reauthentication time expires.



## 64.2 Common System Command Input Values

The following table identifies the values required for many of these commands. Other input values are discussed with the corresponding commands.

Table 294 Input Values for General System Commands

LABEL	DESCRIPTION
<i>address_object</i>	The name of the IP address (group) object. You may use 1-31 alphanumeric characters, underscores(_), or dashes (-), but the first character cannot be a number. This value is case-sensitive.
<i>rule_number</i>	The number of a service control rule. 1 - X where X is the highest number of rules the Zyxel Device model supports.
<i>zone_object</i>	The name of the zone. For some Zyxel Device models, use up to 31 characters (a-zA-Z0-9_-). The name cannot start with a number. This value is case-sensitive.  For other Zyxel Device models, use pre-defined zone names like DMZ, LAN1, SSL VPN, IPsec VPN, OPT, and WAN.

## 64.3 HTTP/HTTPS Commands

The following table describes the commands available for HTTP/HTTPS. You must use the `configure terminal` command to enter the configuration mode before you can use these commands.

Table 295 Command Summary: HTTP/HTTPS

COMMAND	DESCRIPTION
[no] ip http authentication <i>auth_method</i>	Sets an authentication method used by the HTTP/HTTPS server. The <code>no</code> command resets the authentication method used by the HTTP/HTTPS server to the factory default ( <code>default</code> ).  <i>auth_method</i> : The name of the authentication method. You may use 1-31 alphanumeric characters, underscores (_), or dashes (-), but the first character cannot be a number. This value is case-sensitive.
[no] ip http content-security-policy	Sets the content-security-policy header to <b>frame-ancestors 'none'</b> . It prevents loading the web page in an iframe from any source.  The content-security-policy HTTP response header is a security header that can help avoid clickjacking attacks by defining which resources are allowed to loaded or executed.  The <code>no</code> command removes the header directive.  Note: This security is provided only for browsers that support content-security-policy (CSP).
[no] ip http port <1..65535>	Sets the HTTP service port number. The <code>no</code> command resets the HTTP service port number to the factory default (80).
[no] ip http secure-port <1..65535>	Sets the HTTPS service port number. The <code>no</code> command resets the HTTPS service port number to the factory default (443).
[no] ip http secure-server	Enables HTTPS access to the Zyxel Device web configurator. The <code>no</code> command disables HTTPS access to the Zyxel Device web configurator.

Table 295 Command Summary: HTTP/HTTPS (continued)

COMMAND	DESCRIPTION
[no] ip http secure-server auth-client	Sets the client to authenticate itself to the HTTPS server. The <b>no</b> command sets the client not to authenticate itself to the HTTPS server.
[no] ip http secure-server cert <i>certificate_name</i>	Specifies a certificate used by the HTTPS server. The <b>no</b> command resets the certificate used by the HTTPS server to the factory default ( <b>default</b> ).  <i>certificate_name</i> : The name of the certificate. You can use up to 31 alphanumeric and ;'~!@#\$%^&()_+[]{}',.- characters.
[no] ip http secure-server force-redirect	Redirects all HTTP connection requests to a HTTPS URL. The <b>no</b> command disables forwarding HTTP connection requests to a HTTPS URL.
[no] ip http secure-server sslv3	Turns on SSLv3 support in the HTTP server. The <b>no</b> command turns SSLv3 support off.
ip http secure-server table {admin user} rule {rule_number append insert rule_number} access-group {ALL address_object} zone {ALL zone_object} action {accept deny}	Sets a service control rule for HTTPS service.
ip http secure-server table {admin user} rule move rule_number to rule_number	Changes the index number of a HTTPS service control rule.
ip http secure-server cipher-suite {cipher_algorithm} [cipher_algorithm] [cipher_algorithm] [cipher_algorithm]	Sets the encryption algorithms (up to four) that the Zyxel Device uses for the SSL in HTTPS connections and the sequence in which it uses them. The <i>cipher_algorithm</i> can be any of the following.  rc4: RC4 (RC4 may impact the Zyxel Device's CPU performance since the Zyxel Device's encryption accelerator does not support it).  aes: AES  des: DES  3des: Triple DES.
no ip http secure-server cipher-suite {cipher_algorithm}	Has the Zyxel Device not use the specified encryption algorithm for the SSL in HTTPS connections.
[no] ip http server	Allows HTTP access to the Zyxel Device web configurator. The <b>no</b> command disables HTTP access to the Zyxel Device web configurator.
ip http server table {admin user} rule {rule_number append insert rule_number} access-group {ALL address_object} zone {ALL zone_object} action {accept deny}	Sets a service control rule for HTTP service.
ip http server table {admin user} rule move rule_number to rule_number	Changes the number of a HTTP service control rule.
no ip http secure-server table {admin user} rule rule_number	Deletes a service control rule for HTTPS service.
no ip http server table {admin user} rule rule_number	Deletes a service control rule for HTTP service.
ip http skip-csrf-check	Omits cross-site request forgery (CSRF) checking. CSRF exploits the trust that a site has in a user's browser to transmit unauthorized commands as if they are from a user that the website trusts.

Table 295 Command Summary: HTTP/HTTPS (continued)

COMMAND	DESCRIPTION
<code>no ip http skip-csrf-check</code>	Performs cross-site request forgery (CSRF) checking.
<code>[no] ip http x-frame-options</code>	<p>Sets the x-frame-options header to <b>SAMEORIGIN</b>. The web page can only be displayed in a frame on the same origin (from the site/host which is the same as the one serving the page).</p> <p>The x-frame-options HTTP response header is a security header that can help avoid clickjacking attacks by indicating whether a browser is allowed to load a page in a frame.</p> <p>The <code>no</code> command removes the header directive.</p> <p>Note: This security is provided only for browsers that support x-frame-options.</p>
<code>show ip http server status</code>	Displays HTTP settings.
<code>show ip http server secure status</code>	Displays HTTPS settings.
<code>show ip http skip-csrf-check</code>	Shows whether cross-site request forgery (CSRF) checking is done or not.

### 64.3.1 HTTP/HTTPS Command Examples

This following example adds a service control rule that allowed an administrator from the computers with the IP addresses matching the Marketing address object to access the WAN zone using HTTP service.

```
Router# configure terminal
Router(config)# ip http server table admin rule append access-group
Marketing zone WAN action accept
```

This command sets an authentication method Example used by the HTTP/HTTPS server to authenticate the client(s).

```
Router# configure terminal
Router(config)# ip http authentication Example
```

This following example sets a certificate named MyCert used by the HTTPS server to authenticate itself to the SSL client.

```
Router# configure terminal
Router(config)# ip http secure-server cert MyCert
```

## 64.4 SSH

Unlike Telnet or FTP, which transmit data in clear text, SSH (Secure Shell) is a secure communication protocol that combines authentication and data encryption to provide secure encrypted communication between two hosts over an unsecured network.

### 64.4.1 SSH Implementation on the Zyxel Device

Your Zyxel Device supports SSH using RSA authentication and the following encryption methods: AES, 3DES, Archfour, Blowfish. The SSH server is implemented on the Zyxel Device for remote management on port 22 (by default).

### 64.4.2 Requirements for Using SSH

You must install an SSH client program on a client computer (Windows or Linux operating system) that is used to connect to the Zyxel Device over SSH.

### 64.4.3 SSH Commands

The following table describes the commands available for SSH. You must use the `configure terminal` command to enter the configuration mode before you can use these commands.

Table 296 Command Summary: SSH

COMMAND	DESCRIPTION
<code>ssh {user@W.X.Y.Z   or W.X.Y.Z}</code>	Sets the user name where W.X.Y.Z is an IPv4 address or domain of an SSH client.
<code>[no] ip ssh server</code>	Allows SSH access to the Zyxel Device CLI. The <code>no</code> command disables SSH access to the Zyxel Device CLI.
<code>[no] ip ssh server cert <i>certificate_name</i></code>	Sets a certificate whose corresponding private key is to be used to identify the Zyxel Device for SSH connections. The <code>no</code> command resets the certificate used by the SSH server to the factory default ( <code>default</code> ).  <i>certificate_name</i> : The name of the certificate. You can use up to 31 alphanumeric and <code>;'~!@#%&amp;()_+[]}'',.-</code> characters.
<code>[no] ip ssh server port &lt;1..65535&gt;</code>	Sets the SSH service port number. The <code>no</code> command resets the SSH service port number to the factory default (22).
<code>ip ssh server rule {<i>rule_number</i> append insert <i>rule_number</i>} access-group {ALL <i>address_object</i>} zone {ALL <i>zone_object</i>} action {accept deny}</code>	Sets a service control rule for SSH service.  <i>address_object</i> : The name of the IP address (group) object. You may use 1-31 alphanumeric characters, underscores( <code>_</code> ), or dashes ( <code>-</code> ), but the first character cannot be a number. This value is case-sensitive.  <i>zone_object</i> : The name of the zone. For some Zyxel Device models, use up to 31 characters ( <code>a-zA-Z0-9_-</code> ). The name cannot start with a number. This value is case-sensitive.  For other Zyxel Device models, use pre-defined zone names like DMZ, LAN1, SSL VPN, IPsec VPN, OPT, and WAN.
<code>ip ssh server rule move <i>rule_number</i> to <i>rule_number</i></code>	Changes the index number of a SSH service control rule.

Table 296 Command Summary: SSH (continued)

COMMAND	DESCRIPTION
[no] ip ssh server v1	Enables remote management using SSH v1. The no command stops the Zyxel Device from using SSH v1.  This command has been removed from firmware version 4.60 and later, because SSH v1 is no longer supported.
no ip ssh server rule rule_number	Deletes a service control rule for SSH service.
show ip ssh server status	Displays SSH settings.

### 64.4.4 SSH Command Examples

This command sets a service control rule that allowed the computers with the IP addresses matching the specified address object to access the specified zone using SSH service.

```
Router# configure terminal
Router(config)# ip ssh server rule 2 access-group Marketing zone WAN action
accept
```

This command sets a certificate (Default) to be used to identify the Zyxel Device.

```
Router# configure terminal
Router(config)# ip ssh server cert Default
```

## 64.5 Telnet

You can configure your Zyxel Device for remote Telnet access.

## 64.6 Telnet Commands

The following table describes the commands available for Telnet. You must use the `configure terminal` command to enter the configuration mode before you can use these commands.

Table 297 Command Summary: Telnet

COMMAND	DESCRIPTION
[no] ip telnet server	Allows Telnet access to the Zyxel Device CLI. The no command disables Telnet access to the Zyxel Device CLI.
[no] ip telnet server port <1..65535>	Sets the Telnet service port number. The no command resets the Telnet service port number back to the factory default (23).

Table 297 Command Summary: Telnet (continued)

COMMAND	DESCRIPTION
<pre>ip telnet server rule {rule_number append insert rule_number} access-group {ALL address_object} zone {ALL zone_object} action {accept deny}</pre>	<p>Sets a service control rule for Telnet service.</p> <p><i>address_object</i>: The name of the IP address (group) object. You may use 1-31 alphanumeric characters, underscores(_), or dashes (-), but the first character cannot be a number. This value is case-sensitive.</p> <p><i>zone_object</i>: The name of the zone. For some Zyxel Device models, use up to 31 characters (a-zA-Z0-9_-). The name cannot start with a number. This value is case-sensitive.</p> <p>For other Zyxel Device models, use pre-defined zone names like DMZ, LAN1, SSL VPN, IPSec VPN, OPT, and WAN.</p>
<pre>ip telnet server rule move rule_number to rule_number</pre>	Changes the index number of a service control rule.
<pre>no ip telnet server rule rule_number</pre>	Deletes a service control rule for Telnet service.
<pre>show ip telnet server status</pre>	Displays Telnet settings.

### 64.6.1 Telnet Commands Examples

This command sets a service control rule that allowed the computers with the IP addresses matching the specified address object to access the specified zone using Telnet service.

```
Router# configure terminal
Router(config)# ip telnet server rule 11 access-group RD zone LAN action
accept
```

This command displays Telnet settings.

```
Router# configure terminal
Router(config)# show ip telnet server status
active      : yes
port       : 23
service control:
No.  Zone                Address                Action
=====
Router(config)#
```

## 64.7 Configuring FTP

You can upload and download the Zyxel Device's firmware and configuration files using FTP. To use this feature, your computer must have an FTP client.

## 64.7.1 FTP Commands

The following table describes the commands available for FTP. You must use the `configure` terminal command to enter the configuration mode before you can use these commands.

Table 298 Command Summary: FTP

COMMAND	DESCRIPTION
<code>[no] ip ftp server</code>	Allows FTP access to the Zyxel Device. The <code>no</code> command disables FTP access to the Zyxel Device.
<code>[no] ip ftp server cert certificate_name</code>	Sets a certificate to be used to identify the Zyxel Device. The <code>no</code> command resets the certificate used by the FTP server to the factory default.
<code>[no] ip ftp server port &lt;1..65535&gt;</code>	Sets the FTP service port number. The <code>no</code> command resets the FTP service port number to the factory default (21).
<code>[no] ip ftp server tls- required</code>	Allows FTP access over TLS. The <code>no</code> command disables FTP access over TLS.
<code>ip ftp server rule {rule_number append ins ert rule_number} access-group {ALL address_object} zone {ALL zone_object} action {accept deny}</code>	<p>Sets a service control rule for FTP service.</p> <p><i>address_object</i>: The name of the IP address (group) object. You may use 1-31 alphanumeric characters, underscores(_), or dashes (-), but the first character cannot be a number. This value is case-sensitive.</p> <p><i>zone_object</i>: The name of the zone. For some Zyxel Device models, use up to 31 characters (a-zA-Z0-9_). The name cannot start with a number. This value is case-sensitive.</p> <p>For other Zyxel Device models, use pre-defined zone names like DMZ, LAN1, SSL VPN, IPSec VPN, OPT, and WAN.</p>
<code>ip ftp server rule move rule_number to rule_number</code>	Changes the index number of a service control rule.
<code>no ip ftp server rule rule_number</code>	Deletes a service control rule for FTP service.
<code>[no] ip ftp server cipher-suite {3des   des   rc4}</code>	<p>Enables or disables the following ciphers for the FTP service: 3DES, DES, 3DES.</p> <p>These ciphers are considered weak, so from firmware version 4.60 onwards, they are disabled by default.</p>
<code>show ip ftp server status</code>	Displays FTP settings.

## 64.7.2 FTP Commands Examples

This command sets a service control rule that allowed the computers with the IP addresses matching the specified address object to access the specified zone using FTP service.

```
Router# configure terminal
Router(config)# ip ftp server rule 4 access-group Sales zone WAN action
accept
```

This command displays FTP settings.

```

Router# configure terminal
Router(config)# show ip ftp server status
active      : yes
port        : 21
certificate: default
TLS         : no
service control:
No.  Zone                Address                Action
=====
```

## 64.8 SNMP

Simple Network Management Protocol is a protocol used for exchanging management information between network devices. Your Zyxel Device supports SNMP agent functionality, which allows a manager station to manage and monitor the Zyxel Device through the network. The Zyxel Device supports SNMP version one (SNMPv1) version two (SNMPv2c) and version 3 (SNMPv3).

SNMP v3 enhances security for SNMP management using authentication and encryption. SNMP managers can be required to authenticate with agents before conducting SNMP management sessions.

Security can be further enhanced by encrypting the SNMP messages sent from the managers. Encryption protects the contents of the SNMP messages. When the contents of the SNMP messages are encrypted, only the intended recipients can read them.

### 64.8.1 Supported MIBs

The Zyxel Device supports MIB II that is defined in RFC-1213 and RFC-1215. The Zyxel Device also supports private MIBs (zywall.mib and zyxel-zywall-ZLD-Common.mib) to collect information about CPU and memory usage and VPN total throughput. The focus of the MIBs is to let administrators collect statistical data and monitor status and performance. You can download the Zyxel Device's MIBs from [www.zyxel.com](http://www.zyxel.com).

### 64.8.2 SNMP Traps

The Zyxel Device will send traps to the SNMP manager when any one of the following events occurs:

Table 299 SNMP Traps

OBJECT LABEL	OBJECT ID	DESCRIPTION
Cold Start	1.3.6.1.6.3.1.1.5.1	This trap is sent when the Zyxel Device is turned on or an agent restarts.
linkDown	1.3.6.1.6.3.1.1.5.3	This trap is sent when the Ethernet link is down.
linkUp	1.3.6.1.6.3.1.1.5.4	This trap is sent when the Ethernet link is up.
authenticationFailure	1.3.6.1.6.3.1.1.5.5	This trap is sent when an SNMP request comes from non-authenticated hosts.



Table 299 SNMP Traps (continued)

OBJECT LABEL	OBJECT ID	DESCRIPTION
vpnTunnelDisconnected	1.3.6.1.4.1.890.1.6.22.2.3	This trap is sent when an IPsec VPN tunnel is disconnected.
vpnTunnelName	1.3.6.1.4.1.890.1.6.22.2.2.1.1	This trap is sent along with the vpnTunnelDisconnected trap. This trap carries the disconnected tunnel's IPsec SA name.
vpnIKEName	1.3.6.1.4.1.890.1.6.22.2.2.1.2	This trap is sent along with the vpnTunnelDisconnected trap. This trap carries the disconnected tunnel's IKE SA name.
vpnTunnelSPI	1.3.6.1.4.1.890.1.6.22.2.2.1.3	This trap is sent along with the vpnTunnelDisconnected trap. This trap carries the security parameter index (SPI) of the disconnected VPN tunnel.

### 64.8.3 SNMP Commands

The following table describes the commands available for SNMP. You must use the `configure terminal` command to enter the configuration mode before you can use these commands.

Table 300 Command Summary: SNMP

COMMAND	DESCRIPTION
[no] <code>snmp-server</code>	Allows SNMP access to the Zyxel Device. The <code>no</code> command disables SNMP access to the Zyxel Device.
[no] <code>snmp-server community <i>community_string</i> {ro rw}</code>	Enters up to 64 characters to set the password for read-only (ro) or read-write (rw) access. The <code>no</code> command resets the password for read-only (ro) or read-write (rw) access to the default.
[no] <code>snmp-server contact <i>description</i></code>	Sets the contact information (of up to 60 characters) for the person in charge of the Zyxel Device. The <code>no</code> command removes the contact information for the person in charge of the Zyxel Device.
[no] <code>snmp-server enable {informs traps}</code>	Enables all SNMP notifications (informs or traps). The <code>no</code> command disables all SNMP notifications (informs or traps).
[no] <code>snmp-server host {w.x.y.z/fqdn ipv6 address} [<i>community_string</i>]</code>	Sets the IPv4 or IPv6 address of the host that receives the SNMP notifications. The <code>no</code> command removes the host that receives the SNMP notifications.
[no] <code>snmp-server location <i>description</i></code>	Sets the geographic location (of up to 60 characters) for the Zyxel Device. The <code>no</code> command removes the geographic location for the Zyxel Device.
[no] <code>snmp-server port &lt;1..65535&gt;</code>	Sets the SNMP service port number. The <code>no</code> command resets the SNMP service port number to the factory default (161).
<code>snmp-server rule {rule_number append insert rule_number} access-group {ALL address_object} zone {ALL zone_object} action {accept deny}</code>	<p>Sets a service control rule for SNMP service.</p> <p><i>address_object</i>: The name of the IP address (group) object. You may use 1-31 alphanumeric characters, underscores ( _ ), or dashes ( - ), but the first character cannot be a number. This value is case-sensitive.</p> <p><i>zone_object</i>: The name of the zone. For some Zyxel Device models, use up to 31 characters (a-zA-Z0-9_). The name cannot start with a number. This value is case-sensitive.</p> <p>For other Zyxel Device models, use pre-defined zone names like DMZ, LAN1, SSL VPN, IPsec VPN, OPT, and WAN.</p>

Table 300 Command Summary: SNMP (continued)

COMMAND	DESCRIPTION
<code>snmp-server rule move rule_number to rule_number</code>	Changes the index number of a service control rule.
<code>no snmp-server rule rule_number</code>	Deletes a service control rule for SNMP service.
<code>snmp-server v3user username description authentication {md5   sha} privacy {none   des   aes} privilege {ro   rw}</code>	Sets the authentication, privacy and privilege for an SNMPv3 user.
<code>snmp-server version {v2c   v3}</code>	Sets the SNMP version for the Zyxel Device. The SNMP version on the Zyxel Device must match the version on the SNMP manager.
<code>show snmp status</code>	Displays SNMP Settings.
<code>show snmp-server v3user status</code>	Displays authentication, privacy and privilege for configured SNMPv3 users.

## 64.8.4 SNMP Commands Examples

The following command sets a service control rule that allowed the computers with the IP addresses matching the specified address object to access the specified zone using SNMP service.

```
Router# configure terminal
Router(config)# snmp-server rule 11 access-group Example zone WAN action
accept
```

The following command sets the password (secret) for read-write (rw) access.

```
Router# configure terminal
Router(config)# snmp-server community secret rw
```

The following command sets the IP address of the host that receives the SNMP notifications to 172.23.15.84 and the password (sent with each trap) to qwerty.

```
Router# configure terminal
Router(config)# snmp-server host 172.23.15.84 qwerty
```

The following commands create an SNMPv3 rule and then displays the configured settings.

```
Router# configure terminal
Router(config)# snmp-server v3user username john authentication md5 privacy
none privilege rw
Router(config)# show snmp-server v3user status
SNMPv3 user profile: 1
  username: john
  authentication: md5
  privacy: none
  privilege: rw
Router(config)#
```

## 64.9 ICMP Filter

The `ip icmp-filter` commands are obsolete. See [Chapter 29 on page 215](#) to configure secure policy rules for ICMP traffic going to the Zyxel Device to discard or reject ICMP packets destined for the Zyxel Device.

Configure the ICMP filter to help keep the Zyxel Device hidden from probing attempts. You can specify whether or not the Zyxel Device is to respond to probing for unused ports.

You must use the `configure terminal` command to enter the configuration mode before you can use these commands.

Table 301 Command Summary: ICMP Filter

COMMAND	DESCRIPTION
<code>[no] ip icmp-filter activate</code>	Turns the ICMP filter on or off.
<code>ip icmp-filter rule</code> <code>{&lt;1..32&gt; append insert</code> <code>&lt;1..32&gt;} access-group</code> <code>{ALL ADDRESS_OBJECT} zone</code> <code>{ALL ZONE_OBJECT} icmp-type</code> <code>{ALL  echo-reply  destination-</code> <code>unreachable  source-</code> <code>quench redirect echo-request </code> <code>router-advertisement router-</code> <code>solicitation  time-exceeded  </code> <code>parameter-problem timestamp-</code> <code>request timestamp-reply </code> <code>address-mask-request  address-</code> <code>mask-reply} action</code> <code>{accept deny}</code>	Sets an ICMP filter rule.  ADDRESS_OBJECT: The name of the IP address (group) object. You may use 1-31 alphanumeric characters, underscores(_), or dashes (-), but the first character cannot be a number. This value is case-sensitive.  ZONE_OBJECT: The name of the zone. You may use 1-31 alphanumeric characters, underscores(_), or dashes (-), but the first character cannot be a number. This value is case-sensitive.
<code>no ip icmp-filter rule &lt;1..64&gt;</code>	Deletes an ICMP filter rule.
<code>ip icmp-filter rule move</code> <code>&lt;1..64&gt; to &lt;1..64&gt;</code>	Changes the index number of an ICMP filter rule.
<code>show ip icmp-filter status</code>	Displays ICMP filter settings.

# CHAPTER 65

## File Manager

This chapter covers how to work with the Zyxel Device's firmware, certificates, configuration files, custom IDP signatures, packet trace results, shell scripts and temporary files.

### 65.1 File Directories

The Zyxel Device stores files in the following directories.

Table 302 FTP File Transfer Notes

DIRECTORY	FILE TYPE	FILE NAME EXTENSION
A	Firmware (upload only)	bin
cert	Non-PKCS#12 certificates	cer
conf	Configuration files	conf
idp	IDP custom signatures	rules
packet_trace	Packet trace results (download only)	
script	Shell scripts	.zysh
tmp	Temporary system maintenance files and crash dumps for technical support use (download only)	

A. After you log in through FTP, you do not need to change directories in order to upload the firmware.

### 65.2 Configuration Files and Shell Scripts Overview

You can store multiple configuration files and shell script files on the Zyxel Device.

When you apply a configuration file, the Zyxel Device uses the factory default settings for any features that the configuration file does not include. Shell scripts are files of commands that you can store on the Zyxel Device and run when you need them. When you run a shell script, the Zyxel Device only applies the commands that it contains. Other settings do not change.

You can edit configuration files or shell scripts in a text editor and upload them to the Zyxel Device. Configuration files use a .conf extension and shell scripts use a .zysh extension.

These files have the same syntax, which is also identical to the way you run CLI commands manually. An example is shown below.

**Figure 40** Configuration File / Shell Script: Example

```
# enter configuration mode
configure terminal
# change administrator password
username admin password 4321 user-type admin
# configure ge3
interface ge3
ip address 172.23.37.240 255.255.255.0
ip gateway 172.23.37.254 metric 1
exit
# create address objects for remote management / to-ZyWALL firewall rules
# use the address group in case we want to open up remote management later
address-object TW_SUBNET 172.23.37.0/24
object-group address TW_TEAM
address-object TW_SUBNET
exit
# enable Telnet access (not enabled by default, unlike other services)
ip telnet server
# open WAN-to-ZyWALL firewall for TW_TEAM for remote management
secure-policy insert 4
from WAN
to ZyWALL
sourceip TW_TEAM
service TELNET
action allow
exit
write
```

While configuration files and shell scripts have the same syntax, the Zyxel Device applies configuration files differently than it runs shell scripts. This is explained below.

Table 303 Configuration Files and Shell Scripts in the Zyxel Device

Configuration Files (.conf)	Shell Scripts (.zysh)
<ul style="list-style-type: none"> <li>Resets to default configuration.</li> <li>Goes into CLI <b>Configuration</b> mode.</li> <li>Runs the commands in the configuration file.</li> </ul>	<ul style="list-style-type: none"> <li>Goes into CLI <b>Privilege</b> mode.</li> <li>Runs the commands in the shell script.</li> </ul>

You have to run the example in [Table 40 on page 525](#) as a shell script because the first command is run in **Privilege** mode. If you remove the first command, you have to run the example as a configuration file because the rest of the commands are executed in **Configuration** mode. (See [Section 1.5 on page 32](#) for more information about CLI modes.)

## 65.2.1 Comments in Configuration Files or Shell Scripts

In a configuration file or shell script, use “#” or “!” as the first character of a command line to have the Zyxel Device treat the line as a comment.

Your configuration files or shell scripts can use “exit” or a command line consisting of a single “!” to have the Zyxel Device exit sub command mode.

Note: "exit" or "!" must follow sub commands if it is to make the Zyxel Device exit sub command mode.

Line 3 in the following example exits sub command mode.

```
interface ge1
ip address dhcp
!
```

Lines 1 and 3 in the following example are comments and line 4 exits sub command mode.

```
!
interface ge1
# this interface is a DHCP client
!
```

Lines 1 and 2 are comments. Line 5 exits sub command mode.

```
! this is from Joe
# on 2006/06/05
interface ge1
ip address dhcp
!
```

## 65.2.2 Errors in Configuration Files or Shell Scripts

When you apply a configuration file or run a shell script, the Zyxel Device processes the file line-by-line. The Zyxel Device checks the first line and applies the line if no errors are detected. Then it continues with the next line. If the Zyxel Device finds an error, it stops applying the configuration file or shell script and generates a log.

You can have the Zyxel Device to ignore errors and apply the valid parts of the configuration file every time you upload configuration files or only for the specific file you're uploading.

Use `setenv stop-on-error off` if you want the Zyxel Device to ignore errors and apply the valid parts of the configuration file every time you upload configuration files to the Zyxel Device.

Use `apply/conf/file_name.conf ignore-error`, for example, `apply/conf/ATPConfigFile.conf ignore-error`, to:

- Apply the valid parts of the configuration file.
- Generate error logs for all of the configuration file's errors.

This lets the Zyxel Device apply most of your configuration in the configuration file you just uploaded. You can refer to the logs for what to fix.

Use `apply/conf/file_name.conf ignore-error rollback`, for example, `apply/conf/ATPConfigFile.conf ignore-error rollback`, to:

- Generate error logs for all of the configuration file's errors.
- Start the Zyxel Device with the last fully valid configuration file.

This lets the Zyxel Device apply your current configuration file (the **startup-config.conf** file) instead of the configuration file you just uploaded. You can refer to the logs for what to fix.

See the table below for the comparison between these commands.

Table 304 Commands Comparison Table

COMMAND	EFFECTIVE	RESULT
<code>setenv stop-on-error off</code>	every time you upload configuration files  (until you apply the command <code>setenv stop-on-error on</code> )	<ul style="list-style-type: none"> <li>• ignore errors</li> <li>• apply the valid parts of the configuration file</li> <li>• generate error logs</li> </ul>
<code>apply/conf/file_name.conf ignore-error</code>	only for the specific file	<ul style="list-style-type: none"> <li>• ignore errors</li> <li>• apply the valid parts of the configuration file</li> <li>• generate error logs</li> </ul>
<code>apply/conf/file_name.conf ignore-error rollback</code>	only for the specific file	<ul style="list-style-type: none"> <li>• ignore errors</li> <li>• apply the <b>startup-config.conf</b> file</li> <li>• generate error logs</li> </ul>

### 65.2.3 Zyxel Device Configuration File Details

You can store multiple configuration files on the Zyxel Device. You can also have the Zyxel Device use a different configuration file without the Zyxel Device restarting.

- When you first receive the Zyxel Device, it uses the **system-default.conf** configuration file of default settings.
- When you change the configuration, the Zyxel Device creates a **startup-config.conf** file of the current configuration.
- The Zyxel Device checks the **startup-config.conf** file for errors when it restarts. If there is an error in the **startup-config.conf** file, the Zyxel Device copies the **startup-config.conf** configuration file to the **startup-config-bad.conf** configuration file and tries the existing **lastgood.conf** configuration file.
- When the Zyxel Device reboots, if the **startup-config.conf** file passes the error check, the Zyxel Device keeps a copy of the **startup-config.conf** file as the **lastgood.conf** configuration file for you as a back up file. If you upload and apply a configuration file with an error, you can apply **lastgood.conf** to return to a valid configuration.

### 65.2.4 Configuration File Flow at Restart

If there is not a **startup-config.conf** when you restart the Zyxel Device (whether through a management interface or by physically turning the power off and back on), the Zyxel Device uses the **system-default.conf** configuration file with the Zyxel Device's default settings.

If there is a **startup-config.conf**, the Zyxel Device checks it for errors and applies it. If there are no errors, the Zyxel Device uses it and copies it to the **lastgood.conf** configuration file. If there is an error, the Zyxel Device generates a log and copies the **startup-config.conf** configuration file to the **startup-config-bad.conf** configuration file and tries the existing **lastgood.conf** configuration file. If there isn't a **lastgood.conf** configuration file or it also has an error, the Zyxel Device applies the **system-default.conf** configuration file.

You can change the way the **startup-config.conf** file is applied. Include the `setenv-startup stop-on-error off` command. The Zyxel Device ignores any errors in the **startup-config.conf** file and applies all of the valid commands. The Zyxel Device still generates a log for any errors.

## 65.3 File Manager Commands Input Values

The following table explains the values you can input with the file manager commands.

Table 305 File Manager Command Input Values

LABEL	DESCRIPTION
<i>file_name</i>	The name of a file. Use up to 25 characters (including a-zA-Z0-9;~!@#\$\$%^&()_+[]{}',.-).

## 65.4 File Manager Commands Summary

The following table lists the commands that you can use for file management.

Table 306 File Manager Commands Summary

COMMAND	DESCRIPTION
<code>apply /conf/<i>file_name.conf</i> [ignore-error] [rollback]</code>	<p>Has the Zyxel Device use a specific configuration file. You must still use the <code>write</code> command to save your configuration changes to the flash ("non-volatile" or "long term") memory.</p> <p>Use this command without specify both <code>ignore-error</code> and <code>rollback</code>: this is not recommended because it would leave the rest of the configuration blank. If the interfaces were not configured before the first error, the console port may be the only way to access the device.</p> <p>Use <code>ignore-error</code> without <code>rollback</code>: this applies the valid parts of the configuration file and generates error logs for all of the configuration file's errors. This lets the Zyxel Device apply most of your configuration and you can refer to the logs for what to fix.</p> <p>Use both <code>ignore-error</code> and <code>rollback</code>: this applies the valid parts of the configuration file, generates error logs for all of the configuration file's errors, and starts the Zyxel Device with a fully valid configuration file.</p> <p>Use <code>rollback</code> without <code>ignore-error</code>: this gets the Zyxel Device started with a fully valid configuration file as quickly as possible.</p> <p>You can use the "<code>apply /conf/system-default.conf</code>" command to reset the Zyxel Device to go back to its system defaults.</p>
<code>copy {/conf   /idp   /packet_trace   /script   /tmp}<i>file_name-a.conf</i> {/conf   /idp   /packet_trace   /script   /tmp}/<i>file_name-b.conf</i></code>	<p>Saves a duplicate of a file on the Zyxel Device from the source file name to the target file name.</p> <p>Specify the directory and file name of the file that you want to copy and the directory and file name to use for the duplicate. Always copy the file into the same directory.</p>



Table 306 File Manager Commands Summary (continued)

COMMAND	DESCRIPTION
<code>copy running-config startup-config</code>	Saves your configuration changes to the flash ("non-volatile" or "long term") memory. The Zyxel Device immediately uses configuration changes made via commands, but if you do not use this command or the <code>write</code> command, the changes will be lost when the Zyxel Device restarts.
<code>copy running-config /conf/ file_name.conf</code>	Saves a duplicate of the configuration file that the Zyxel Device is currently using. You specify the file name to which to copy.
<code>delete {/conf   /idp   /packet_trace   /script   /tmp}/file_name</code>	Removes a file. Specify the directory and file name of the file that you want to delete.
<code>dir {/conf   /idp   /packet_trace   /script   /tmp}</code>	Displays the list of files saved in the specified directory.
<code>rename {/conf   /idp   /packet_trace   /script   /tmp}/old-file_name {/ conf   /idp   /packet_trace   / script   /tmp}/new-file_name</code>	Changes the name of a file.  Specify the directory and file name of the file that you want to rename. Then specify the directory again followed by the new file name.
<code>rename /script/old-file_name / script/new-file_name</code>	Changes the name of a shell script.
<code>run /script/file_name.zysh</code>	Has the Zyxel Device execute a specific shell script file. You must still use the <code>write</code> command to save your configuration changes to the flash ("non-volatile" or "long term") memory.
<code>schedule-run 1 file_name.zysh {daily   monthly   weekly} time {date   sun   mon   tue   wed   thu   fri   sat}</code>	Has the Zyxel Device execute the specified specific shell script file at the the specified time. You must still use the <code>write</code> command to save your configuration changes to the flash ("non-volatile" or "long term") memory.
<code>show running-config</code>	Displays the settings of the configuration file that the system is using.
<code>setenv-startup stop-on-error off</code>	Has the Zyxel Device ignore any errors in the startup-config.conf file and apply all of the valid commands.
<code>show setenv-startup</code>	Displays whether or not the Zyxel Device is set to ignore any errors in the startup-config.conf file and apply all of the valid commands.
<code>write</code>	Saves your configuration changes to the flash ("non-volatile" or "long term") memory. The Zyxel Device immediately uses configuration changes made via commands, but if you do not use the <code>write</code> command, the changes will be lost when the Zyxel Device restarts.

## 65.5 File Manager Dual Firmware Commands

The following table lists the commands that you can use for managing dual firmware. Firmware uploaded using FTP goes to the Running partition. Use the web configurator to upload firmware to the

Standby partition. The Zyxel Device reboots automatically when you upload firmware to the Running partition.

Table 307 File Manager Dual Firmware Commands

COMMAND	DESCRIPTION
set firmware boot option <0..1>	Sets the behavior of the Zyxel Device when firmware is uploaded to the Standby partition. (This command does not upload firmware.) Use 0 to have the Zyxel Device reboot immediately after firmware is uploaded to the Standby partition and become the Running firmware. Use 1 to not have the Zyxel Device reboot immediately after a firmware is uploaded to the Standby partition.
show firmware image boot option	Shows the behavior of the Zyxel Device when firmware is uploaded to the Standby partition.
set firmware boot number <1..2>	Reboots the Zyxel Device immediately with firmware in partition 1 or 2. If 2 is the Standby partition, then it becomes the Running partition after reboot. Use <code>show version</code> to see which partition is Standby and which is Running.

## 65.6 File Manager Command Examples

These are examples of the dual firmware commands .

```
Router(config)# set firmware boot option 0
Router(config)#
Router(config)# show firmware image boot option
boot option: 0
Router(config)#
Router(config)# set firmware boot number 2

Welcome to USG110

Username:
Terminate All Processes: OK
kill_process_and_umountfs() returns -7
Restarting system.

<snipped>

Welcome to USG110
Username: admin
Password:
Router> configure terminal
Router(config)# show version
Zyxel Communications Corp.
image number model                firmware version
build date          boot status
=====
1          USG110                V4.11 (AAPH.0)b3s1
2015-01-11 21:53:44 Standby
2          USG110                V4.11 (AAPH.0)
2015-03-13 03:47:52 Running
```

This example saves a back up of the current configuration before applying a shell script file.

```
Router(config)# copy running-config /conf/backup.conf
Router(config)# run /script/vpn_setup.zysh
```

These commands run the aaa.zysh script at noon every day, on the first day of every month, and on every Monday, Wednesday, and Friday.

```
Router> configure terminal
Router(config)# schedule-run 1 aaa.zysh daily 12:00
Router(config)# schedule-run 1 aaa.zysh monthly 12:00 01
Router(config)# schedule-run 1 aaa.zysh weekly 12:00 mon wed fri
Router(config)#
```

## 65.7 FTP File Transfer

You can use FTP to transfer files to and from the Zyxel Device for advanced maintenance and support.

### 65.7.1 Command Line FTP File Upload

- 1 Connect to the Zyxel Device.
- 2 Enter "bin" to set the transfer mode to binary.
- 3 You can upload the firmware after you log in through FTP. To upload other files, use "cd" to change to the corresponding directory.
- 4 Use "put" to transfer files from the computer to the Zyxel Device.<sup>1</sup> For example:  
In the conf directory, use "put config.conf today.conf" to upload the configuration file (config.conf) to the Zyxel Device and rename it "today.conf".  
"put 1.00(XL.0).bin" transfers the firmware (1.00(XL.0).bin) to the Zyxel Device.

**The firmware update can take up to five minutes. Do not turn off or reset the Zyxel Device while the firmware update is in progress! If you lose power during the firmware upload, you may need to refer to [Section 65.10 on page 538](#) to recover the firmware.**

### 65.7.2 Command Line FTP Configuration File Upload Example

The following example transfers a configuration file named tomorrow.conf from the computer and saves it on the Zyxel Device as next.conf.

---

1. When you upload a custom signature, the Zyxel Device appends it to the existing custom signatures stored in the "custom.rules" file.

Note: Uploading a custom signature file named "custom.rules", overwrites all custom signatures on the ZyWALL.

**Figure 41** FTP Configuration File Upload Example

```
C:\>ftp 192.168.1.1
Connected to 192.168.1.1.
220 FTP Server (ZyWALL) [192.168.1.1]
User (192.168.1.1:(none)): admin
331 Password required for admin.
Password:
230 User admin logged in.
ftp> cd conf
250 CWD command successful
ftp> bin
200 Type set to I
ftp> put tomorrow.conf next.conf
200 PORT command successful
150 Opening BINARY mode data connection for next.conf
226-Post action ok!!
226 Transfer complete.
ftp: 20231 bytes sent in 0.00Seconds 20231000.00Kbytes/sec.
```

### 65.7.3 Command Line FTP File Download

- 1 Connect to the Zyxel Device.
- 2 Enter "bin" to set the transfer mode to binary.
- 3 Use "cd" to change to the directory that contains the files you want to download.
- 4 Use "dir" or "ls" if you need to display a list of the files in the directory.
- 5 Use "get" to download files. For example:  
"get vpn\_setup.zysh vpn.zysh" transfers the vpn\_setup.zysh configuration file on the Zyxel Device to your computer and renames it "vpn.zysh."

### 65.7.4 Command Line FTP Configuration File Download Example

The following example gets a configuration file named today.conf from the Zyxel Device and saves it on the computer as current.conf.

**Figure 42** FTP Configuration File Download Example

```

C:\>ftp 192.168.1.1
Connected to 192.168.1.1.
220 FTP Server (ZyWALL) [192.168.1.1]
User (192.168.1.1:(none)): admin
331 Password required for admin.
Password:
230 User admin logged in.
ftp> bin
200 Type set to I
ftp> cd conf
250 CWD command successful
ftp> get today.conf current.conf
200 PORT command successful
150 Opening BINARY mode data connection for conf/today.conf
(20220 bytes)
226 Transfer complete.
ftp: 20220 bytes received in 0.03Seconds 652.26Kbytes/sec.

```

## 65.8 Cloud Helper Commands

Cloud Helper lets you know if there is a later firmware available on the Cloud Helper server and lets you download it one is available.

Note: To use this feature, you must register your Zyxel Device at [myZyxel.com](http://myZyxel.com).

Table 308 Cloud Helper Commands

COMMAND	DESCRIPTION
show cloud-helper autoupdate firmware	Shows if automatically updating firmware is enabled, the schedule and if automatically rebooting the Zyxel Device is enabled (meaning the uploaded firmware becomes the running firmware).
show cloud-helper firmware	Displays latest firmware information available on the Cloud Helper server.
show cloud-helper highlight	Displays the number of unread notifications.
show cloud-helper notify_all	Displays all notifications on the Zyxel Device, including the name, description, and URL.
show cloud-helper remind	Displays whether the popup reminder about new available firmware is enabled or disabled.
show cloud-helper retry	Shows the number of retry_times, retry_period and retry_fail_period. retry_times: The number of attempts allowed to download items. retry_period: The length of time between download attempts. retry_fail_period: The retry interval after retry attempts have expired.
cloud-helper check all	Sends a query to the Cloud Helper Server to get the latest firmware, Geo IP, IDP signature and SSL CA certificate information.
cloud-helper check app	Sends a query to the Cloud Helper Server to get the latest App Patrol signature information.
cloud-helper check app_incr	Sends a query to the Cloud Helper Server to get the latest incremental App Patrol signature information.

Table 308 Cloud Helper Commands (continued)

COMMAND	DESCRIPTION
<code>cloud-helper check av</code>	Sends a query to the Cloud Helper Server to get the latest Antivirus signature information.
<code>cloud-helper check botnet</code>	Sends a query to the Cloud Helper Server to get the latest URL Threat Filter signature information.
<code>cloud-helper check ctdb</code>	Sends a query to the Cloud Helper Server to get the latest Content Filter signature information.
<code>cloud-helper check firmware</code>	Sends a query to the Cloud Helper Server to get the latest firmware information.
<code>cloud-helper check geoip</code>	Sends a query to the Cloud Helper Server to get the latest Geo IP information.
<code>cloud-helper check idp</code>	Sends a query to the Cloud Helper Server to get the latest IDP signature information.
<code>cloud-helper check rf</code>	Sends a query to the Cloud Helper Server to get the latest Reputation Filter signature information.
<code>cloud-helper check sslca</code>	Sends a query to the Cloud Helper Server to get the latest SSL CA certificate information.
<code>cloud-helper check-notify new_features_cdr</code>	Checks for new notifications relating to CDR.
<code>cloud-helper check-notify new_features_dns_cf</code>	Checks for new notifications relating to DNS Content Filtering.
<code>cloud-helper check-notify new_features_rap</code>	Checks for new notifications relating to Remote Access Points (RAP).
<code>cloud-helper check-notify now</code>	Checks for all new notifications.
<code>cloud-helper check-notify service_expired</code>	Checks for new notifications relating to services that are expired on the Zyxel Device.
<code>cloud-helper check-notify whats_new</code>	Checks for new notifications relating to Remote Access Points (RAP).
<code>cloud-helper clean-download firmware</code>	Stops and removes a firmware being downloaded to the Zyxel Device.
<code>[no] cloud-helper firmware update auto</code>	Lets the Zyxel Device automatically check for and download new firmware to the standby partition at the time and day specified.  The <code>no</code> command disallows the Zyxel Device automatically checking for and downloading new firmware.
<code>cloud-helper firmware update daily &lt;0..23&gt; reboot {no   yes}</code>	Has the Zyxel Device check for new firmware every day at the specified time. The time format is the 24 hour clock, so '0' means midnight, 01 means 1AM and so on. Configure <code>reboot yes</code> to have the Zyxel Device automatically restart making the newly downloaded firmware in the standby partition become the running firmware.
<code>cloud-helper firmware update weekly {fri   mon   sat   sun   thu   tue   wed} &lt;0..23&gt; reboot {no   yes}</code>	Has the Zyxel Device check for new firmware once a week on the day and at the time specified.  Configure <code>reboot yes</code> to have the Zyxel Device automatically restart making the newly downloaded firmware in the standby partition become the running firmware.  If you configure both <code>weekly</code> and <code>daily</code> commands, then the command that takes effect is the last one configured.
<code>cloud-helper get app</code>	Downloads the latest App Patrol signatures from the Cloud Helper server to the Zyxel Device.

Table 308 Cloud Helper Commands (continued)

COMMAND	DESCRIPTION
<code>cloud-helper get av</code>	Downloads the latest Antivirus signatures from the Cloud Helper server to the Zyxel Device.
<code>cloud-helper get botnet</code>	Downloads the latest URL Threat Filter signatures from the Cloud Helper server to the Zyxel Device.
<code>cloud-helper get firmware &lt;1..2&gt;</code>	Downloads the latest firmware on the Cloud Helper server to the specified system space on the Zyxel Device.
<code>cloud-helper get idp</code>	Downloads the latest IDP signature on the Cloud Helper server to the Zyxel Device.
<code>cloud-helper get sslca</code>	Downloads the latest SSL certificate on the Cloud Helper server to the Zyxel Device.
<code>cloud-helper pause-download firmware &lt;1..2&gt;</code>	Temporarily stops a firmware being downloaded to the specified system space on the Zyxel Device.
<code>cloud-helper set {[retry_times &lt;1..10&gt;]} {[retry_period &lt;2..60&gt;]} {[retry_fail_period &lt;180..720&gt;]}</code>	Specifies criteria for how the Zyxel Device should download firmware, security service signatures, and SSL certificates from the Cloud Helper server.  <code>retry_times</code> : Up to 10 attempts are allowed to download items.  <code>retry_period</code> : The retry interval must be between 2 and 60 seconds.  <code>retry_fail_period</code> : The retry interval after retry attempts have expired must be between 180 and 720 seconds.
<code>cloud-helper set remind {every-time   never}</code>	Enables or disables a notification that appears when logging in, reminding the Zyxel Device admin that new firmware is available.
<code>cloud-helper set-read new_features_cdr</code>	Marks all CDR notifications as read.
<code>cloud-helper set-read new_features_dns_cf</code>	Marks all DNS Content Filter notifications as read.
<code>cloud-helper set-read service_expired</code>	Marks all Service Expired notifications as read.
<code>cloud-helper set-read whats_new</code>	Marks all What's New notifications as read.
<code>cloud-helper update firmware &lt;1..2&gt;</code>	Resumes a firmware being downloaded to the specified system space on the Zyxel Device.
<code>[no] cloud-helper-notify activate</code>	Enables the Cloud Helper notifications service, which checks for new new, app updates, and firmware updates.  The <code>no</code> command disables the service and hides notifications.

## 65.8.1 Cloud Helper Command Examples

These are examples of Cloud Helper commands.

```
Router(config)#
Router(config)# cloud-helper check firmware
=====
Cloud status      : NORMAL
firmware version  : 4.20(AAPL.0)b5
firmware release  : 2016-07-15T02:29:11Z
firmware md5      : 752ed3f2d8296e669ea2146c29523bda
firmware news file: YES
firmware note file: YES
firmware message file: NO
boot status       : Running
=====
Cloud status      : NORMAL
firmware version  : 4.20(AAPL.0)b5
firmware release  : 2016-07-15T02:29:11Z
firmware md5      : 752ed3f2d8296e669ea2146c29523bda
firmware news file: YES
firmware note file: YES
firmware message file: NO
boot status       : Standby
Router(config)#
```



```

Router(config)#
Router# show cloud-helper autoupdate firmware
auto: no
schedule: daily at 18 o'clock
autoreboot: no
Router(config)# cloud-helper set retry_times 5 retry_period 6 retry_fail_period 200
Router# show cloud-helper retry
retry_times: 5
retry_period: 6 min
retry_fail_period: 200 min
Router(config)#
Router# show cloud-helper firmware
WARNING: can not get fw fw_md5 info
=====
Cloud status      : NORMAL
firmware version  : 4.20(AAKZ.2)
firmware release  : 2016-11-29T01:42:39Z
firmware md5      :
firmware news file: YES
firmware note file: YES
firmware message file: YES
boot status       : Running
WARNING: can not get fw fw_md5 info
=====
Cloud status      : NORMAL
firmware version  : 4.20(AAKZ.2)
firmware release  : 2016-11-29T01:42:39Z
firmware md5      :
firmware news file: YES
firmware note file: YES
firmware message file: YES
boot status       : Standby
Router(config)#

```

## 65.9 Zyxel Device File Usage at Startup

The Zyxel Device uses the following files at system startup.

**Figure 43** Zyxel Device File Usage at Startup

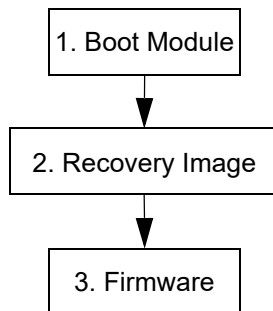

- 1 The boot module performs a basic hardware test. You cannot restore the boot module if it is damaged. The boot module also checks and loads the recovery image. The Zyxel Device notifies you if the recovery image is damaged.
- 2 The recovery image checks and loads the firmware. The Zyxel Device notifies you if the firmware is damaged.

## 65.10 Notification of a Damaged Recovery Image or Firmware

The Zyxel Device's recovery image and/or firmware could be damaged, for example by the power going off during a firmware upgrade. This section describes how the Zyxel Device notifies you of a damaged recovery image or firmware file. Use this section if your device has stopped responding for an extended period of time and you cannot access or ping it. Note that the Zyxel Device does not respond while starting up. It takes less than five minutes to start up with the default configuration, but the start up time increases with the complexity of your configuration.

- 1 Use a console cable and connect to the Zyxel Device via a terminal emulation program (such as HyperTerminal). Your console session displays the Zyxel Device's startup messages. If you cannot see any messages, check the terminal emulation program's settings (see [Section 1.2.1 on page 27](#)) and restart the Zyxel Device.
- 2 The system startup messages display followed by "Press any key to enter debug mode within 3 seconds."

Note: Do not press any keys at this point. Wait to see what displays next.

**Figure 44** System Startup Stopped

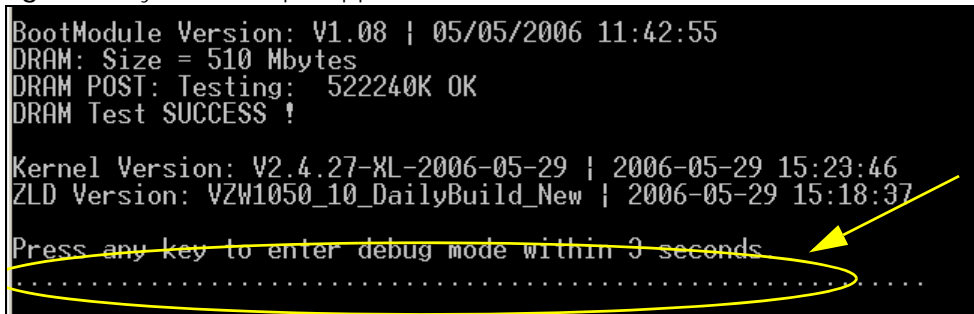

```

BootModule Version: V1.08 | 05/05/2006 11:42:55
DRAM: Size = 510 Mbytes
DRAM POST: Testing: 522240K OK
DRAM Test SUCCESS !

Kernel Version: V2.4.27-XL-2006-05-29 | 2006-05-29 15:23:46
ZLD Version: VZW1050_10_DailyBuild_New | 2006-05-29 15:18:37

Press any key to enter debug mode within 3 seconds
.....

```

- 3 If the console session displays "Invalid Firmware", or "Invalid Recovery Image", or the console freezes at "Press any key to enter debug mode within 3 seconds" for more than one minute, go to [Section 65.11 on page 539](#) to restore the recovery image.

Figure 45 Recovery Image Damaged

```

Press any key to enter debug mode within 3 seconds.
.....
Invalid Recovery Image
ERROR
Enter Debug Mode
>

```

- 4 If “Connect a computer to port 1 and FTP to 192.168.1.1 to upload the new file” displays on the screen, the firmware file is damaged. Use the procedure in [Section 65.12 on page 541](#) to restore it. If the message does not display, the firmware is OK and you do not need to use the firmware recovery procedure.

Figure 46 Firmware Damaged

```

Building ...
Connect a computer to port 1 and FTP to 192.168.1.1 to upload the new file.
|

```

## 65.11 Restoring the Recovery Image

This procedure requires the Zyxel Device’s recovery image. Download the firmware package from [www.zyxel.com](http://www.zyxel.com) and unzip it. The recovery image uses a .ri extension, for example, “1.01(XL.0)C0.ri”. Do the following after you have obtained the recovery image file.

Note: You only need to use this section if you need to restore the recovery image.

- 1 Restart the Zyxel Device.
- 2 When “Press any key to enter debug mode within 3 seconds.” displays, press a key to enter debug mode.

Figure 47 Enter Debug Mode

```

BootModule Version: V1.011 | 2007-03-30 12:22:57
DRAM: Size = 510 Mbytes
DRAM POST: Testing: 522240K OK
DRAM Test SUCCESS !

Kernel Version: U2.4.27-kernel-2006-08-21 | 2006-08-21 19:54:00
ZLD Version: V1.01(XL.0) | 2006-09-11 17:41:56

Press any key to enter debug mode within 3 seconds.
.....
Enter Debug Mode
> █

```

- 3 Enter `atuk` to initialize the recovery process. If the screen displays “ERROR”, enter `atur` to initialize the recovery process.



- 7 Enter `atgo`. The Zyxel Device starts up. If “Connect a computer to port 1 and FTP to 192.168.1.1 to upload the new file” displays on the screen, the firmware file is damaged and you need to use the procedure in [Section 65.12 on page 541](#) to recover the firmware.

**Figure 52** atgo Debug Command

```
> atgo
Booting...
```

## 65.12 Restoring the Firmware

This procedure requires the Zyxel Device’s firmware. Download the firmware package from [www.zyxel.com](http://www.zyxel.com) and unzip it. The firmware file uses a `.bin` extension, for example, “1.01(XL.0)C0.bin”. Do the following after you have obtained the firmware file.

Note: This section is not for normal firmware uploads. You only need to use this section if you need to recover the firmware.

- 1 Connect your computer to the Zyxel Device’s port 1 (only port 1 can be used).
- 2 The Zyxel Device’s FTP server IP address for firmware recovery is 192.168.1.1, so set your computer to use a static IP address from 192.168.1.2 ~192.168.1.254.
- 3 Use an FTP client on your computer to connect to the Zyxel Device. For example, in the Windows command prompt, type `ftp 192.168.1.1`. Keep the console session connected in order to see when the firmware recovery finishes.
- 4 Hit enter to log in anonymously.
- 5 Set the transfer mode to binary (type `bin`).
- 6 Transfer the firmware file from your computer to the Zyxel Device. Type `put` followed by the path and name of the firmware file. This examples uses `put e:\ftproot\ZLD_FW\1.01(XL.0)C0.bin`.

**Figure 53** FTP Firmware Transfer Command

```
C:\>ftp 192.168.1.1
Connected to 192.168.1.1.
220-=(<<*>)=-.: << Welcome to PureFTPd 1.0.11 >> .:.-=<<*>)=
220-You are user number 1 of 50 allowed
220-Local time is now 21:33 and the load is 0.01. Server port: 21.
220-Only anonymous FTP is allowed here
220 You will be disconnected after 15 minutes of inactivity.
User <192.168.1.1:<none>>:
230 Anonymous user logged in
ftp> bi
200 TYPE is now 8-bit binary
ftp> put E:\ftproot\ZLD_FW\1.00XL0c0\1.00(XL.0)C0.bin_
```

- 7 Wait for the file transfer to complete.

**Figure 54** FTP Firmware Transfer Complete

```

200 PORT command successful
150 Connecting to port 1564
226-87.0 Mbytes free disk space
226-File successfully transferred
226 3.231 seconds (measured here), 10.83 Mbytes per second
ftp: 36708858 bytes sent in 3.23Seconds 11350.91Kbytes/sec.
ftp> _

```

- 8 After the transfer is complete, "Firmware received" or "ZLD-current received" displays. Wait (up to four minutes) while the Zyxel Device recovers the firmware.

**Figure 55** Firmware Received and Recovery Started

```

Firmware received ...

[Update Filesystem]
  Updating Code
  ..

```

- 9 The console session displays "done" when the firmware recovery is complete. Then the Zyxel Device automatically restarts.

**Figure 56** Firmware Recovery Complete and Restart

```

.....
.....
.....
.....
.....
.....
.....
.....
done
[Update Kernel]
  Extracting Kernel Image
  ..
  done
  Writing Kernel Image ... done

[Update BootModule]
  Extracting BootModule Image
  .
  done
  Writing BootModule
  ..
.....
Restarting system.
.....
done

```

- 10 The username prompt displays after the Zyxel Device starts up successfully. The firmware recovery process is now complete and the Zyxel Device is ready to use.

Figure 57 Restart Complete

```
Setting the System Clock using the Hardware Clock as reference...
System Clock set. Local time: Sun Jan 26 21:40:24 UTC 2003

Cleaning: /tmp /var/lock /var/run.
Initializing random number generator... done.
Initializing Debug Account Authentication Seed (DAAS)... done.
Lionic device init successfully
cavium nitrox device CN1005 init complete
INIT: Entering runlevel: 3
Starting zylog daemon: zylogd zylog starts.
Starting syslog-ng.
Starting uam daemon.
Starting app patrol daemon.
Starting periodic command scheduler: cron.
Start ZyWALL system daemon...
Got LINK_CHANGE
Port [0] is up --> Group [0] is up
Applying system configuration file, please wait...
ZyWALL system is configured successfully with startup-config.conf

Welcome to ZyWALL 1050

Username: █
```

## 65.13 Restoring the Default System Database

The default system database stores information such as the default anti-virus or IDP signatures. The Zyxel Device can still operate if the default system database is damaged or missing, but related features (like anti-virus or IDP) may not function properly.

If the default system database file is not valid, the Zyxel Device displays a warning message in your console session at startup or when reloading the anti-virus or IDP signatures. It also generates a log. Here are some examples. Use this section to restore the Zyxel Device's default system database.

**Figure 58** Default System Database Console Session Warning at Startup: Anti-Virus

```

Hostname: localhost.

Setting the System Clock using the Hardware Clock as reference...
System Clock set. Local time: Fri May 11 09:31:55 GMT 2007

Cleaning: /tmp /var/lock /var/run.
Initializing random number generator... done.
Initializing Debug Account Authentication Seed (DAAS)... done.
INIT: Entering runlevel: 3
Starting zylog daemon: zylogd zylog starts.
Starting syslog-ng.
Starting uam daemon.
Starting app patrol daemon.
Starting periodic command scheduler: cron.
Start ZyWALL system daemon...
Got LINK_CHANGE
Port [1] is up --> Group [1] is up
% Anti-Virus signatures missing, refer to your user documentation to recover the
default database file.
% Loading AV signature database has failed.
Applying system configuration file, please wait...
ZyWALL system is configured successfully with startup-config.conf

Welcome to ZyWALL USG 300

Username:

```

**Figure 59** Default System Database Console Session Warning When Reloading IDP

```

Router(config)# idp reload
IDP signatures missing, please refer to your user documentation to recover the
default database file.
retval = -32056
ERROR: Enable IDP engine failed.
Router(config)#

```

**Figure 60** Default System Database Missing Log: Anti-Virus

#	Time	Priority	Category	Message
1	2007-05-11 11:25:00	info	IDP	New IDP rule has been appended.
2	2007-05-11 11:24:59	info	IDP	New IDP rule has been appended.
3	2007-05-11 11:24:59	info	IDP	IDP profile DMZ_IDP has been modified.
4	2007-05-11 11:24:59	info	IDP	IDP profile DMZ_IDP has been created.
5	2007-05-11 11:24:59	info	IDP	IDP profile LAN_IDP has been modified.
6	2007-05-11 11:24:59	info	IDP	IDP profile LAN_IDP has been created.
7	2007-05-11 11:24:59	info	IDP	Enable IDP succeeded.
8	2007-05-11 11:23:42	alert	IDP	IDP signatures missing, please refer to your user documentation to recover the default datab

This procedure requires the Zyxel Device's default system database file. Download the firmware package from [www.zyxel.com](http://www.zyxel.com) and unzip it. The default system database file uses a .db extension, for example, "1.01(XL.0)C0.db". Do the following after you have obtained the default system database file.



### 65.13.1 Using the atkz -u Debug Command

Note: You only need to use the `atkz -u` command if the default system database is damaged.

- 1 Restart the Zyxel Device.
- 2 When "Press any key to enter debug mode within 3 seconds." displays, press a key to enter debug mode.

**Figure 61** Enter Debug Mode

```

BootModule Version: V1.011 | 2007-03-30 12:22:57
DRAM: Size = 510 Mbytes
DRAM POST: Testing: 522240K OK
DRAM Test SUCCESS !

Kernel Version: V2.4.27-kernel-2006-08-21 | 2006-08-21 19:54:00
ZLD Version: V1.01(XL.0) | 2006-09-11 17:41:56

Press any key to enter debug mode within 3 seconds.
.....
Enter Debug Mode

> █

```

- 3 Enter `atkz -u` to start the recovery process.

**Figure 62** `atkz -u` Command for Restoring the Default System Database

```

> atkz -u
-u
OK

> atgo
Booting...

```

- 4 "Connect a computer to port 1 and FTP to 192.168.1.1 to upload the new file" displays on the screen. Connect your computer to the Zyxel Device's port 1 (only port 1 can be used).

**Figure 63** Use FTP with Port 1 and IP 192.168.1.1 to Upload File

```

Checking CODE ... Done

Updating ...

Connect a computer to port 1 and FTP to 192.168.1.1 to upload the new file.

```

- 5 The Zyxel Device's FTP server IP address for firmware recovery is 192.168.1.1, so set your computer to use a static IP address from 192.168.1.2 ~192.168.1.254.
- 6 Use an FTP client on your computer to connect to the Zyxel Device. For example, in the Windows command prompt, type `ftp 192.168.1.1`. Keep the console session connected in order to see when the default system database recovery finishes.
- 7 Hit enter to log in anonymously.
- 8 Set the transfer mode to binary (type `bin`).

- 9 Transfer the firmware file from your computer to the Zyxel Device. Type `put` followed by the path and name of the firmware file. This examples uses `put e:\ftproot\ZLD_FW\1.01(XL.0)C0.db`.

**Figure 64** FTP Default System Database Transfer Command

```
C:\>ftp 192.168.1.1
Connected to 192.168.1.1.
220-=(*)=-.:. << Welcome to PureFTPd 1.0.11 >> .:.-=(*)=-
220-You are user number 1 of 50 allowed
220-Local time is now 03:56 and the load is 0.00. Server port: 21.
220-Only anonymous FTP is allowed here
220 You will be disconnected after 15 minutes of inactivity.
User <192.168.1.1:(none)>:
230 Anonymous user logged in
ftp> bin
200 TYPE is now 8-bit binary
ftp> put E:\ftproot\ZLD_FW\101XL\101XL0C0\1.01(XL.0)C0.db
```

- 10 Wait for the file transfer to complete.

**Figure 65** FTP Default System Database Transfer Complete

```
200 PORT command successful
150 Connecting to port 3709
226-248.5 Mbytes free disk space
226-File successfully transferred
226 0.008 seconds (measured here), 13.31 Mbytes per second
ftp: 112398 bytes sent in 0.02Seconds 7024.88Kbytes/sec.
ftp> _
```

- 11 The console session displays “done” after the default system database is recovered.

**Figure 66** Default System Database Received and Recovery Complete

```
Default System Database received ...

[Update Filesystem]
  Updating Database
  .
  done
```

- 12 The username prompt displays after the Zyxel Device starts up successfully. The default system database recovery process is now complete and the Zyxel Device IDP and anti-virus features are ready to use again.

Figure 67 Startup Complete

```
nothing was mounted
Hostname: localhost.

Setting the System Clock using the Hardware Clock as reference...
System Clock set. Local time: Wed May 9 03:26:53 UTC 2007

Cleaning: /tmp /var/lock /var/run.
Initializing random number generator... done.
Initializing Debug Account Authentication Seed (DAAS)... done.
Lionic device init successfully
cavium nitrox device CN505 init complete
INIT: Entering runlevel: 3
Starting zylog daemon: zylogd zylog starts.
Starting syslog-ng.
Starting uam daemon.
Starting app patrol daemon.
Starting periodic command scheduler: cron.
Start ZyWALL system daemon...
Got LINK_CHANGE
Port [1] is up --> Group [1] is up
Got LINK_CHANGE
Port [0] is up --> Group [0] is up
Applying system configuration file, please wait...
ZyWALL system is configured successfully with startup-config.conf

Welcome to ZyWALL 1050

Username:
```

# CHAPTER 66

## Logs

This chapter provides information about the Zyxel Device's logs.

Note: When the system log reaches the maximum number of log messages, new log messages automatically overwrite existing log messages, starting with the oldest existing log message first.

See the User's Guide for the maximum number of system log messages in the Zyxel Device.

### 66.1 Log Commands Summary

The following table describes the values required for many log commands. Other values are discussed with the corresponding commands.

Table 309 Input Values for Log Commands

LABEL	DESCRIPTION
<i>interface_name</i>	<p>The name of the interface.</p> <p>Ethernet interface: For some Zyxel Device models, use <i>gex</i>, <math>x = 1 - N</math>, where <math>N</math> equals the highest numbered Ethernet interface for your Zyxel Device model.</p> <p>For other Zyxel Device models, use a name such as <i>wan1</i>, <i>wan2</i>, <i>opt</i>, <i>lan1</i>, or <i>dmz</i>.</p> <p>Virtual interface on top of Ethernet interface: add a colon (:) and the number of the virtual interface. For example: <i>gex:y</i>, <math>x = 1 - N</math>, <math>y = 1 - 4</math></p> <p>VLAN interface: <i>vlanx</i>, <math>x = 0 - 4094</math></p> <p>Virtual interface on top of VLAN interface: <i>vlanx:y</i>, <math>x = 0 - 4094</math>, <math>y = 1 - 12</math></p> <p>Bridge interface: <i>brx</i>, <math>x = 0 - N</math>, where <math>N</math> depends on the number of bridge interfaces your Zyxel Device model supports.</p> <p>Virtual interface on top of bridge interface: <i>brx:y</i>, <math>x =</math> the number of the bridge interface, <math>y = 1 - 4</math></p> <p>PPPoE/PPTP interface: <i>pppx</i>, <math>x = 0 - N</math>, where <math>N</math> depends on the number of PPPoE/PPTP interfaces your Zyxel Device model supports.</p>
<i>module_name</i>	<p>The name of the category; <i>kernel</i>, <i>syslog</i>, .... The default category includes debugging messages generated by open source software. The <i>all</i> category includes all messages in all categories.</p> <p>To view a list of categories, run command <i>show logging status system-log</i>.</p>
<i>protocol</i>	The name of a protocol such as TCP, UDP, ICMP.

The following sections list the logging commands.

## 66.1.1 Log Entries Commands

This table lists the commands to look at log entries.

Table 310 logging Commands: Log Entries

COMMAND	DESCRIPTION
<pre>show logging entries [priority <i>pri</i>] [category <i>module_name</i>] [srcip <i>ip</i>] [srcip6 <i>ipv6_addr</i>] [dstip <i>ip</i>] [dstip6 <i>ipv6_addr</i>] [service <i>service_name</i>] [begin &lt;1..512&gt; end &lt;1..512&gt;] [keyword <i>keyword</i>] [srciface <i>interface_name</i>] [dstiface <i>interface_name</i>] [protocol <i>protocol</i>]</pre>	<p>Displays the specified entries in the system log.</p> <p><i>pri</i>: alert   crit   debug   emerg   error   info   notice   warn</p> <p><i>keyword</i>: You can use alphanumeric and ( ) + / : = ? ! * # @ \$ _ % - characters, and it can be up to 63 characters long. This searches the message, source, destination, and notes fields.</p>
<pre>show logging entries field <i>field</i> [begin &lt;1..512&gt; end &lt;1..512&gt;]</pre>	<p>Displays the specified fields in the system log.</p> <p><i>field</i>: time   msg   src   dst   note   pri   cat   all</p>

## 66.1.2 System Log Commands

This table lists the commands for the system log settings.

Table 311 logging Commands: System Log Settings

COMMAND	DESCRIPTION
<pre>show logging status system-log</pre>	Displays the current settings for the system log.
<pre>logging system-log category <i>module_name</i> {disable   level normal   level all}</pre>	Specifies what kind of information, if any, is logged in the system log and debugging log for the specified category.
<pre>[no] logging system-log suppression interval &lt;10..600&gt;</pre>	Sets the log consolidation interval for the system log. The no command sets the interval to ten.
<pre>[no] logging system-log suppression</pre>	Enables log consolidation in the system log. The no command disables log consolidation in the system log.
<pre>[no] logging cef-format include year</pre>	Includes the year in the cef (Common Event Format) syslog-compatible format.
<pre>[no] connectivity-check continuous-log activate</pre>	Has the Zyxel Device generate a log for each connectivity check. The no command has the Zyxel Device only log the first connectivity check.
<pre>show connectivity-check continuous-log status</pre>	Displays whether or not the Zyxel Device generates a log for each connectivity check.
<pre>clear logging system-log buffer</pre>	Clears the system log.
<pre>[no] logging usb-storage</pre>	Saves the system logs to a USB storage device, if one is connected.  The [no] command disables this feature.
<pre>logging usb-storage category <i>module_name</i> level {all   normal}</pre>	Specifies what kind of information, if any, is logged to the USB storage device for the specified category.
<pre>logging usb-storage delete over- keep-duration</pre>	Deletes all log messages stored on the USB that are older than keep-duration.
<pre>logging usb-storage flushThreshold &lt;1..100&gt;</pre>	Sets how many new log messages must be created on the Zyxel Device before the new messages are written to the USB storage device.

Table 311 logging Commands: System Log Settings (continued)

COMMAND	DESCRIPTION
[no] logging usb-storage keep-duration	Sets a limit on how long log files are stored on the USB storage device, before being automatically deleted. This helps prevent the storage device from running out of space.  The [no] command removes the limit, meaning log files are stored forever.
logging usb-storage keep-duration day <1..365>	Sets how long, in days, that log files are kept on the USB storage device before being automatically deleted.

### 66.1.2.1 System Log Command Examples

The following command displays the current status of the system log.

```
Router# configure terminal
Router(config)# show logging status system-log
512 events logged
suppression active : yes
suppression interval: 10
category settings :
  content-filter      : normal , forward-web-sites : no      ,
  blocked-web-sites  : normal , user              : normal ,
  myZyxel.com        : normal , zysh              : normal ,
  idp                 : normal , app-patrol         : normal ,
  ike                 : normal , ipsec              : normal ,
  firewall            : normal , sessions-limit    : normal ,
  policy-route        : normal , built-in-service  : normal ,
  system              : normal , connectivity-check: normal ,
  device-ha           : normal , routing-protocol  : normal ,
  nat                 : normal , pki                : normal ,
  interface           : normal , interface-statistics: no  ,
  account             : normal , port-grouping     : normal ,
  force-auth          : normal , l2tp-over-ipsec   : normal ,
  anti-virus          : normal , white-list        : normal ,
  black-list          : normal , ssl-vpn           : normal ,
  cnm                 : normal , traffic-log        : no   ,
  file-manage         : normal , dial-in           : normal ,
  adp                 : normal , default            : all  ,
```

### 66.1.3 Debug Log Commands

This table lists the commands for the debug log settings.

Table 312 logging Commands: Debug Log Settings

COMMAND	DESCRIPTION
show logging debug status	Displays the current settings for the debug log.
show logging debug entries [priority <i>pri</i> ] [category <i>module_name</i> ] [srcip <i>ip</i> ] [srcip6 <i>ipv6_addr</i> ] [dstip <i>ip</i> ] [dstip6 <i>ipv6_addr</i> ] [service <i>service_name</i> ] [srciface <i>interface_name</i> ] [dstiface <i>interface_name</i> ] [protocol <i>protocol</i> ] [begin <1..512> end <1..512>] [keyword <i>keyword</i> ]	Displays the specified entries in the system log.  <i>pri</i> : alert   crit   debug   emerg   error   info   notice   warn  <i>keyword</i> : You can use alphanumeric and () +/ :=?!*#@\$_%- characters, and it can be up to 63 characters long. This searches the message, source, destination, and notes fields.

Table 312 logging Commands: Debug Log Settings (continued)

COMMAND	DESCRIPTION
<code>show logging debug entries field <i>field</i></code> <code>[begin &lt;1..1024&gt; end &lt;1..1024&gt;]</code>	Displays the specified field in the debug log. <i>field</i> : time   msg   src   dst   note   pri   cat   all
<code>[no] logging debug suppression</code>	Enables log consolidation in the debug log. The <code>no</code> command disables log consolidation in the debug log.
<code>[no] logging debug suppression interval</code> <code>&lt;10..600&gt;</code>	Sets the log consolidation interval for the debug log. The <code>no</code> command sets the interval to ten.
<code>clear logging debug buffer</code>	Clears the debug log.

This table lists the commands for the remote syslog server settings. For the purposes of this device's CLI, Access Points are referred to as WTPs.

Table 313 logging Commands: Remote Syslog Server Settings

COMMAND	DESCRIPTION
<code>show logging status syslog</code>	Displays the current settings for the remote servers.
<code>[no] logging syslog &lt;1..4&gt;</code>	Enables the specified remote server. The <code>no</code> command disables the specified remote server.
<code>[no] logging syslog &lt;1..4&gt; address {<i>ip</i>   <i>hostname</i>}</code>	Sets the URL or IP address of the specified remote server. The <code>no</code> command clears this field. <i>hostname</i> : You may up to 63 alphanumeric characters, dashes (-), or periods (.), but the first character cannot be a period.
<code>[no] logging syslog &lt;1..4&gt; {disable   level normal   level all}</code>	Specifies what kind of information, if any, is logged for the specified category.
<code>[no] logging syslog &lt;1..4&gt; facility {local_1   local_2   local_3   local_4   local_5   local_6   local_7}</code>	Sets the log facility for the specified remote server. The <code>no</code> command sets the facility to local_1.
<code>[no] logging syslog &lt;1..4&gt; format {cef   vrpt}</code>	Sets the format of the log information. <i>cef</i> : Common Event Format, syslog-compatible format. <i>vrpt</i> : Zyxel's Vantage Report, syslog-compatible format.

This table lists the commands for setting how often to send information to the VRPT (Zyxel's Vantage Report) server.

Table 314 logging Commands: VRPT Settings

COMMAND	DESCRIPTION
<code>vrpt send device information interval</code> <code>&lt;15..3600&gt;</code>	Sets the interval (in seconds) for how often the Zyxel Device sends a device information log to the VRPT server.
<code>vrpt send interface statistics interval</code> <code>&lt;15..3600&gt;</code>	Sets the interval (in seconds) for how often the Zyxel Device sends an interface statistics log to the VRPT server.
<code>vrpt send system status interval &lt;15..3600&gt;</code>	Sets the interval (in seconds) for how often the Zyxel Device sends a system status log to the VRPT server.
<code>show vrpt send device information interval</code>	Displays the interval (in seconds) for how often the Zyxel Device sends a device information log to the VRPT server.
<code>show vrpt send interface statistics interval</code>	Displays the interval (in seconds) for how often the Zyxel Device sends an interface statistics log to the VRPT server.

Table 314 logging Commands: VRPT Settings (continued)

COMMAND	DESCRIPTION
show vrpt send system status interval	Displays the interval (in seconds) for how often the Zyxel Device sends a system status log to the VRPT server.
MODULE_NAME_WTP	{user  zysh  built-in-service  system  system-monitoring  routing-protocol  pki  interface  interface-statistics  account  force-auth  traffic-log  file-manage  wlan  daily-report  dhcp  default  capwap  wlan-station-info  all}
FACILITY	{local_1  local_2  local_3  local_4  local_5  local_6  local_7}
HOSTNAME	"([a-z0-9\.)+\.)+([a-z]{2}\.[a-z]{2}  [a-z]{2,4})"
USER_NAME_	"([0-9]  [a-z]  [A-Z]  [-_]   \.   \@   [0-9]  [a-z]  [A-Z]  [-_])+"
ZYLOG_SUBJECT	"[a-zA-Z0-9 '()+,./:=?;!*#@\$_%]{1,61}"<subject>";
MODULE_NAME_WTP_	{user  zysh  built-in-service  system  routing-protocol  pki  interface  account  force-auth  file-manage  wlan  daily-report  dhcp  default  capwap  wlan-station-info  all}
WEEKDAYS	{sun  mon  tue  wed  thu  fri  sat}

## 66.1.4 E-mail Profile Commands

This table lists the commands for the e-mail profile settings.

Table 315 logging Commands: E-mail Profile Settings

COMMAND	DESCRIPTION
show logging status mail	Displays the current settings for the e-mail profiles.
[no] logging mail <1..2>	Enables the specified e-mail profile. The <b>no</b> command disables the specified e-mail profile.
[no] logging mail <1..2> address {ip   hostname}	Sets the URL or IP address of the mail server for the specified e-mail profile. The <b>no</b> command clears the mail server field.  <i>hostname</i> : You may use up to 63 alphanumeric characters, dashes (-), or periods (.), but the first character cannot be a period.
logging mail <1..2> sending_now	Sends mail for the specified e-mail profile immediately, according to the current settings.
[no] logging mail <1..2> tls activate	Select Transport Layer Security (TLS) if you want encrypted communications between the mail server and the Zyxel Device.
[no ]logging mail <1..2> tls authenticate-server	If you choose TLS Security, you may also select this to have the Zyxel Device authenticate the mail server in the TLS handshake.
[no] logging mail <1..2> authentication	Enables SMTP authentication. The <b>no</b> command disables SMTP authentication.
[no] logging mail <1..2> authentication username <i>username</i> password <i>password</i>	Sets the username and password required by the SMTP mail server. The <b>no</b> command clears the username and password fields.  <i>username</i> : You can use alphanumeric characters, underscores (_), and dashes (-), and it can be up to 31 characters long.  <i>password</i> : You can use most printable ASCII characters. You cannot use square brackets [ ], double quotation marks ("), question marks (?), tabs or spaces. It can be up to 63 characters long.
[no] logging mail <1..2> port <1..65535>	Sets the port number of the mail server for the specified e-mail profile.



Table 315 logging Commands: E-mail Profile Settings (continued)

COMMAND	DESCRIPTION
[no] logging mail <1..2> {send-log-to   send-alerts-to} <i>e_mail</i>	Sets the e-mail address for logs or alerts. The no command clears the specified field.  <i>e_mail</i> : You can use up to 63 alphanumeric characters, underscores (_), or dashes (-), and you must use the @ character.
[no] logging mail <1..2> subject <i>subject</i>	Sets the subject line when the Zyxel Device mails to the specified e-mail profile. The no command clears this field.  <i>subject</i> : You can use up to 60 alphanumeric characters, underscores (_), dashes (-), or !@#\$%* ( ) += ; : ' , . / characters.
[no] logging mail <1..2> category <i>module_name</i> level {alert   all}	Specifies what kind of information is logged for the specified category. The no command disables logging for the specified category.
[no] logging mail <1..2> schedule {full   hourly}	Sets the e-mail schedule for the specified e-mail profile. The no command clears the schedule field.
logging mail <1..2> schedule daily hour <0..23> minute <0..59>	Sets a daily e-mail schedule for the specified e-mail profile.
logging mail <1..2> schedule weekly day <i>day</i> hour <0..23> minute <0..59>	Sets a weekly e-mail schedule for the specified e-mail profile.  <i>day</i> : sun   mon   tue   wed   thu   fri   sat
[no] logging mail <1..2> tls starttls-off	Turns off STARTTLS and uses the TLS protocol for SMTP mail encryption over TLS logging. The no command enables the default STARTTLS protocol.

### 66.1.4.1 E-mail Profile Command Examples

The following commands set up e-mail log 1.

```
Router# configure terminal
Router(config)# logging mail 1 address mail.zyxel.com.tw
Router(config)# logging mail 1 subject AAA
Router(config)# logging mail 1 authentication username lachang.li password
XXXXXX
Router(config)# logging mail 1 send-log-to lachang.li@zyxel.com.tw
Router(config)# logging mail 1 send-alerts-to lachang.li@zyxel.com.tw
Router(config)# logging mail 1 from lachang.li@zyxel.com.tw
Router(config)# logging mail 1 schedule weekly day mon hour 3 minute 3
Router(config)# logging mail 1
```

### 66.1.5 Console Port Logging Commands

This table lists the commands for the console port settings.

Table 316 logging Commands: Console Port Settings

COMMAND	DESCRIPTION
show logging status console	Displays the current settings for the console log. (This log is not discussed above.)
[no] logging console	Enables the console log. The no command disables the console log.

Table 316 logging Commands: Console Port Settings (continued)

COMMAND	DESCRIPTION
logging console category <i>module_name</i> level {alert   crit   debug   emerg   error   info   notice   warn}	Controls whether or not debugging information for the specified priority is displayed in the console log, if logging for this category is enabled.
[no] logging console category <i>module_name</i>	Enables logging for the specified category in the console log. The <b>no</b> command disables logging.

# CHAPTER 67

## Reports and Reboot

This chapter provides information about the report associated commands and how to restart the Zyxel Device using commands. It also covers the daily report e-mail feature.

### 67.1 Report Commands Summary

The following sections list the report, session, and packet size statistics commands.

#### 67.1.1 Report Commands

This table lists the commands for reports.

Table 317 report Commands

COMMAND	DESCRIPTION
[no] report	Begins data collection. The <b>no</b> command stops data collection.
show report status	Displays whether or not the Zyxel Device is collecting data and how long it has collected data.
clear report [interface_name]	Clears the report for the specified interface or for all interfaces.
show report [interface_name {ip   service   url}]	Displays the traffic report for the specified interface and controls the format of the report. Formats are: <b>ip</b> - traffic by IP address and direction <b>service</b> - traffic by service and direction <b>url</b> - hits by URL

## 67.1.2 Report Command Examples

The following commands start collecting data, display the traffic reports, and stop collecting data.

```
Router# configure terminal
Router(config)# show report ge1 ip
No. IP Address      User                Amount              Direction
=====
1  192.168.1.4      admin              1273 (bytes)       Outgoing
2  192.168.1.4      admin              711 (bytes)        Incoming
Router(config)# show report ge1 service
No. Port  Service            Amount              Direction
=====
1  21      ftp                1273 (bytes)       Outgoing
2  21      ftp                711 (bytes)        Incoming
Router(config)# show report ge1 url
No. Hit      URL
=====
1  1          140.114.79.60
Router(config)# show report status
Report status: on
Collection period: 0 days 0 hours 0 minutes 18 seconds
```

## 67.1.3 Session Commands

This table lists the commands to display the current sessions for debugging or statistical analysis.

Table 318 Session Commands

COMMAND	DESCRIPTION
<pre>show conn [user {username any unknown}] [service {service- name any unknown}] [source {ip any}] [destination {ip any}] [begin &lt;1..128000&gt;] [end &lt;1..128000&gt;] [dstcc {country-code any}] [srtcc {country-code any}] fastpath</pre>	<p>Displays information about the selected sessions, a number of sessions (begin, end) or about all sessions. You can look at all the active sessions or filter the information by user name, service object, source IP, destination IP, country or session number(s).</p> <p>any means all users, services, countries and IP addresses respectively.</p> <p>unknown means unknown users and services respectively.</p> <p>dstcc and srtcc mean source and destination country code.</p> <p>country_code: 2-letter country-codes, such as TW, DE, or FR. Use <code>show country-code list</code> to see the codes that represent countries.</p> <p>fastpath Packets that pass through the Zyxel Device are inspected and either allowed through or dropped based on the security policy. IPv4 Packets that match the current connections in the fast path can pass through the Zyxel Device without unnecessary security policy checks. This feature maximizes performance.</p>
<pre>show report [interface_name] https-url</pre>	<p>Displays the most-visited Web sites accessed via SSL through the specified interface and how many times each site has been visited.</p>
<pre>show conn ip-traffic destination</pre>	<p>Displays information about traffic session sorted by the destination.</p>
<pre>show conn ip-traffic source</pre>	<p>Displays information about traffic session sorted by the source.</p>
<pre>show conn status</pre>	<p>Displays the number of active sessions.</p>

## 67.1.4 Packet Size Statistics Commands

Using the packet size statistics to view packet size distribution may aid you in troubleshooting network performance. In particular, a large number of small packets can drastically reduce throughput. This table lists the commands to enable and disable packet size statistics data collection and display the setting status and statistics.

Table 319 Packet Size Statistics Commands

COMMAND	DESCRIPTION
<code>[no] report packet size statistics</code>	Enables or disables packet size statistics data collection.
<code>show report packet size statistics status</code>	Shows whether packet size statistics data collection is enabled or disabled.
<code>show report packet size statistics {interface_name} [interval interval]</code>	Displays the specified interface's packet size distribution statistics. You can also specify the packet size interval into which to group the statistics. <i>interval</i> : 128, 256, or 512 (bytes)
<code>report packet size statistics clear</code>	Clears the packet size statistics data for all interface.

## 67.2 Email Daily Report Commands

The following table identifies the values used in some of these commands. Other input values are discussed with the corresponding commands.

Table 320 Input Values for Email Daily Report Commands

LABEL	DESCRIPTION
<code>e_mail</code>	An e-mail address. You can use up to 80 alphanumeric characters, underscores ( <code>_</code> ), periods ( <code>.</code> ), or dashes ( <code>-</code> ), and you must use the <code>@</code> character.

Use these commands to have the Zyxel Device e-mail you system statistics every day. You must use the `configure terminal` command to enter the configuration mode before you can use these commands.

Table 321 Email Daily Report Commands

COMMAND	DESCRIPTION
<code>show daily-report status</code>	Displays the e-mail daily report settings.
<code>daily-report</code>	Enters the sub-command mode for configuring daily e-mail reports settings.
<code>[no] activate</code>	Turns daily e-mail reports on or off.
<code>draw-usage-graphics</code>	Has the report e-mail include usage graphs.
<code>smtp-address {ip   hostname}</code>	Sets the SMTP mail server IP address or domain name.
<code>[no] smtp-auth activate</code>	Enables or disables SMTP authentication.
<code>smtp-auth username username password password</code>	Sets the username and password for SMTP authentication.
<code>no smtp-address</code>	Resets the SMTP mail server configuration.
<code>no smtp-auth username</code>	Resets the authentication configuration.
<code>[no] smtp-port &lt;1..65535&gt;</code>	Sets the SMTP port. The <code>no</code> command deletes the setting.

Table 321 Email Daily Report Commands (continued)

COMMAND	DESCRIPTION
<code>mail-subject set <i>subject</i></code>	Configures the subject of the report e-mails. Spaces are allowed.
<code>no mail-subject set</code>	Clears the configured subject for the report e-mails.
<code>[no] mail-subject append <i>system-name</i></code>	Determines whether the system name will be appended to the subject of the report e-mails.
<code>[no] mail-subject append <i>date-time</i></code>	Determines whether the sending date-time will be appended at subject of the report e-mails.
<code>[no] mail-from <i>e_mail</i></code>	Sets the sender e-mail address of the report e-mails.
<code>[no] mail-to-1 <i>e_mail</i></code>	Sets to whom the Zyxel Device sends the report e-mails (up to five recipients).
<code>[no] mail-to-2 <i>e_mail</i></code>	See above.
<code>[no] mail-to-3 <i>e_mail</i></code>	See above.
<code>[no] mail-to-4 <i>e_mail</i></code>	See above.
<code>[no] mail-to-5 <i>e_mail</i></code>	See above.
<code>[no] item as-report</code>	Determines whether or not anti-spam statistics are included in the report e-mails.
<code>[no] item av-report</code>	Determines whether or not anti-virus statistics are included in the report e-mails.
<code>[no] item cf-report</code>	Determines whether or not content filtering statistics are included in the report e-mails.
<code>[no] item cpu-usage</code>	Determines whether or not CPU usage statistics are included in the report e-mails.
<code>[no] item idp-report</code>	Determines whether or not IDP statistics are included in the report e-mails.
<code>[no] item mem-usage</code>	Determines whether or not memory usage statistics are included in the report e-mails.
<code>[no] item port-usage</code>	Determines whether or not port usage statistics are included in the report e-mails.
<code>[no] item session-usage</code>	Determines whether or not session usage statistics are included in the report e-mails.
<code>[no] item traffic-report</code>	Determines whether or not network traffic statistics are included in the report e-mails.
<code>schedule hour &lt;0..23&gt; minute &lt;00..59&gt;</code>	Sets the time for sending out the report e-mails.
<code>[no] reset-counter</code>	Determines whether or not to discard all report data and starts all of the report statistics data counters over at zero after successfully sending out a report e-mail.
<code>send-now</code>	Sends the daily e-mail report immediately.
<code>reset-counter-now</code>	Discards all report data and starts all of the report statistics data counters over at zero.
<code>[no] smtp-tls starttls-off</code>	Turns off STARTTLS and uses the TLS protocol for SMTP mail encryption over TLS for the daily report. The no command enables the default STARTTLS protocol.
<code>exit</code>	Leaves the sub-command mode.

## 67.2.1 Email Daily Report Example

This example sets the following about sending a daily report e-mail:

- Disables the reporting.
- Specifies example-SMTP-mail-server.com as the address of the SMTP mail server.
- Sets the subject of the report e-mails to test.
- Stops the system name from being appended to the mail subject.
- Appends the date and time to the mail subject.
- Sets the sender as my-email@example.com.
- Sets example-administrator@example.com as the first account to which to send the mail.
- Has the Zyxel Device not use the second and third mail-to options.
- Sets my-email@example.com as the fourth mail-to option.
- Has the Zyxel Device not use the fifth mail-to option.
- Has the Zyxel Device provide username 12345 and password 12345 to the SMTP server for authentication.
- Sets the Zyxel Device to send the report at 1:57 PM.
- Has the Zyxel Device not reset the counters after sending the report.
- Has the report include CPU, memory, port, and session usage along with traffic statistics.
- Turns on the daily e-mail reporting.

```
Router(config)# daily-report
Router(config-daily-report)# no activate
Router(config-daily-report)# smtp-address example-SMTP-mail-server.com
Router(config-daily-report)# mail-subject set test
Router(config-daily-report)# no mail-subject append system-name
Router(config-daily-report)# mail-subject append date-time
Router(config-daily-report)# mail-from my-email@example.com
Router(config-daily-report)# mail-to-1 example-administrator@example.com
Router(config-daily-report)# no mail-to-2
Router(config-daily-report)# no mail-to-3
Router(config-daily-report)# mail-to-4 my-email@example.com
Router(config-daily-report)# no mail-to-5
Router(config-daily-report)# smtp-auth activate
Router(config-daily-report)# smtp-auth username 12345 password pass12345
Router(config-daily-report)# schedule hour 13 minutes 57
Router(config-daily-report)# no reset-counter
Router(config-daily-report)# item cpu-usage
Router(config-daily-report)# item mem-usage
Router(config-daily-report)# item port-usage
Router(config-daily-report)# item session-usage
Router(config-daily-report)# item traffic-report
Router(config-daily-report)# activate
Router(config-daily-report)# exit
Router(config)#
```

This displays the email daily report settings and has the Zyxel Device send the report.

```
Router(config)# show daily-report status
email daily report status
=====
activate: yes
scheduled time: 13:57
reset counter: no
smtp address: example-SMTP-mail-server.com
smtp port: 25
smtp auth: yes
smtp username: 12345
smtp password: pass12345
mail subject: test subject
append system name: no
append date time: yes
mail from: my-email@example.com
mail-to-1: example-administrator@example.com
mail-to-2:
mail-to-3:
mail-to-4: my-email@example.com
mail-to-5:
cpu-usage: yes
mem-usage: yes
session-usage: yes
port-usage: yes
traffic-report: yes

Router(config)# daily-report send-now
```

## 67.3 Reboot

Use this to restart the device (for example, if the device begins behaving erratically).

If you made changes in the CLI, you have to use the `write` command to save the configuration before you reboot. Otherwise, the changes are lost when you reboot.

Use the `reboot` command to restart the device.



# CHAPTER 68

## Diagnostics and Remote Assistance

This chapter covers how to use the diagnostics feature. See also [Chapter 71 on page 569](#) for information on other maintenance tools.

### 68.1 Diagnostics

The diagnostics feature provides an easy way for you to generate a file containing the Zyxel Device's configuration and diagnostic information. You may need to generate this file and send it to customer support during troubleshooting.

### 68.2 Diagnosis Commands

The following table lists the commands that you can use to have the Zyxel Device collect diagnostics information. Use the `configure terminal` command to enter the configuration mode to be able to use these commands.

Table 322 diagnosis Commands

COMMAND	DESCRIPTION
<code>diag-info collect</code>	Has the Zyxel Device create a new diagnostic file.
<code>show diag-info</code>	Displays the name, size, and creation date (in yyyy-mm-dd hh:mm:ss format) of the diagnostic file.
<code>show cpu average</code>	Displays the current percentage usage of each CPU in the Zyxel Device as a percentage of total processing power and the current CPU utilization percentage for each application used on the Zyxel Device.
<code>show mem status all</code>	Displays the current DRAM memory utilization percentage for each application used on the Zyxel Device and each application's running time in hours - minutes - seconds.
<code>diaginfo collect ac</code>	Collects information on the AP controller (the Zyxel Device).
<code>diaginfo collect wtp</code>	Collects information on Access Points managed by the AP controller (the Zyxel Device).
<code>diaginfo delete / ac</code>	Deletes information collected on the AP controller (the Zyxel Device).
<code>diaginfo delete / wtp</code>	Deletes information collected on Access Points managed by the AP controller (the Zyxel Device).

Table 322 diagnosis Commands (continued)

COMMAND	DESCRIPTION
<code>nslookup {ipv4   hostname} [server ipv4] [extension filter-extension]</code>	<p>Performs name server lookup for querying a Domain Name System (DNS) server to get the domain name or IPv4 address mapping.</p> <p>The <code>server</code> and <code>extension</code> fields are optional.</p> <p><i>filter_extension</i>: You can use 1-256 alphanumeric characters, spaces, or '()+,/:=?!*#@\$_%.- characters.</p>
<code>nslookup6 {ipv6   hostname} [server ipv6] [extension filter-extension]</code>	<p>Performs name server lookup for querying a Domain Name System (DNS) server to get the domain name or IPv6 address mapping.</p> <p>The <code>server</code> and <code>extension</code> fields are optional.</p> <p><i>filter_extension</i>: You can use 1-256 alphanumeric characters, spaces, or '()+,/:=?!*#@\$_%.- characters.</p>

## 68.3 Diagnosis Commands Example

The following example creates a diagnostic file and displays its name, size, and creation date.

```
Router# configure terminal
Router(config)# diag-info collect
Please wait, collecting information
Router(config)# show diag-info
Filename   : diainfo-20070423.tar.bz2
File size  : 1259 KB
Date       : 2014-04-23 09:55:09
```

The following is an example of the `nslookup` command.

```
Router# nslookup www.zyxel.com.tw
Trying "www.zyxel.com.tw"
;; ->>HEADER<<- opcode: QUERY, status: NOERROR, id: 42419
;; flags: qr rd ra; QUERY: 1, ANSWER: 1, AUTHORITY: 0, ADDITIONAL: 0

;; QUESTION SECTION:
;www.zyxel.com.tw.                IN      ANY

;; ANSWER SECTION:
www.zyxel.com.tw.                38400   IN      CNAME   origin-tw.zyxel.com.

Received 67 bytes from 127.0.0.1#53 in 1 ms
Router#
```

## 68.4 Remote Assistance

Use Remote Assistance commands to configure and schedule external access to the Zyxel Device for troubleshooting. You can also specify the port numbers the services must use to connect to the Zyxel Device.

Note: Remote Assistance is not available in firmware version 4.50 or later.

## 68.5 Remote Assistance Commands

The following table lists the commands that you can use to configure Remote Assistance on the Zyxel Device. Use the `configure terminal` command to enter the configuration mode to be able to use these commands.

Table 323 remote-assistance Commands

COMMAND	DESCRIPTION
<code>(no) remote-assistance activate</code>	Enables an external person, such as customer support to access the Zyxel Device from a network outside the Zyxel Device local network for troubleshooting.  The <code>no</code> command disables remote assistance.
<code>remote-assistance [https ssh] port port</code>	Sets the service port number for external access. It should be the same port number as the one configured on the Zyxel Device.
<code>remote-assistance [address1 address2] ipv4</code>	Sets the public IPv4 addresses of external users that are allowed to access the Zyxel Device remotely.
<code>remote-assistance remove {address1 address2}</code>	Removes the public IPv4 addresses of external users that are allowed to access the Zyxel Device remotely.
<code>remote-assistance settings [random manual]</code>	<code>random</code> allows access to the Zyxel Device remotely by using a randomly generated user name and password pair.  <code>manual</code> allows access to the Zyxel Device remotely by using a previously configured specific user account.
<code>remote-assistance user-object user</code>	Specifies a previously created user/group object that can have external access to the Zyxel Device for troubleshooting.
<code>remote-assistance generate user-password</code>	Randomly generates a user name and password pair for remote access to the Zyxel Device.
<code>remote-assistance schedule DATE TIME date time</code>	Specifies a date (yyyy-mm-dd) and time (hh-mm) that external access is allowed.
<code>show remote-assistance</code>	Displays configured remote assistance settings including randomly generated user name / password, addresses, access ports and schedule.
<code>show remote-assistance generate</code>	Displays randomly generated user name / password for remote assistance.

# CHAPTER 69

## Session Timeout

Use these commands to modify and display the session timeout values. You must use the `configure terminal` command before you can use these commands.

Table 324 Session Timeout Commands

COMMAND	DESCRIPTION
<code>session timeout {udp-connect &lt;1..300&gt;   udp-deliver &lt;1..300&gt;   icmp &lt;1..300&gt;}</code>	Sets the timeout for UDP sessions to connect or deliver and for ICMP sessions.
<code>session timeout session {tcp-established   tcp-synrecv   tcp-close   tcp-finwait   tcp-synsent   tcp-closewait   tcp-lastack   tcp-timewait} &lt;1..300&gt;</code>	Sets the timeout for TCP sessions in the ESTABLISHED, SYN_RECV, FIN_WAIT, SYN_SENT, CLOSE_WAIT, LAST_ACK, or TIME_WAIT state.
<code>show session timeout {icmp   tcp-timewait   udp}</code>	Displays ICMP, TCP, and UDP session timeouts.

The following example sets the UDP session connect timeout to 10 seconds, the UDP deliver session timeout to 15 seconds, and the ICMP timeout to 15 seconds.

```
Router(config)# session timeout udp-connect 10
Router(config)# session timeout udp-deliver 15
Router(config)# session timeout icmp 15
Router(config)# show session timeout udp
UDP session connect timeout: 10 seconds
UDP session deliver timeout: 15 seconds
Router(config)# show session timeout icmp
ICMP session timeout: 15 seconds
```

# CHAPTER 70

## Packet Flow Explore

This chapter covers how to use the packet flow explore feature.

### 70.1 Packet Flow Explore

Use this to get a clear picture on how the Zyxel Device determines where to forward a packet and how to change the source IP address of the packet according to your current settings. This function provides you a summary of all your routing and SNAT settings and helps troubleshoot the related problems.

### 70.2 Packet Flow Explore Commands

The following table lists the commands that you can use to have the Zyxel Device display routing and SNAT related settings.

Table 325 Packet Flow Explore Commands

COMMAND	DESCRIPTION
<code>show route order</code>	Displays the order of routing related functions the Zyxel Device checks for packets. Once a packet matches the criteria of a routing rule, the Zyxel Device takes the corresponding action and does not perform any further flow checking.
<code>show system snat order</code>	Displays the order of SNAT related functions the Zyxel Device checks for packets. Once a packet matches the criteria of an SNAT rule, the Zyxel Device uses the corresponding source IP address and does not perform any further flow checking.
<code>show system route policy-route</code>	Displays activated policy routes.
<code>show system route nat-1-1</code>	Displays activated 1-to-1 NAT rules.
<code>show system route site-to-site-vpn</code>	Displays activated site-to-site VPN rules.
<code>show system route dynamic-vpn</code>	Displays activated dynamic VPN rules.
<code>show system route default-wan-trunk</code>	Displays the default WAN trunk settings.
<code>show ip route static-dynamic</code>	Displays activated static-dynamic routes.
<code>show system snat policy-route</code>	Displays activated policy routes which use SNAT.
<code>show system snat nat-1-1</code>	Displays activated NAT rules which use SNAT.
<code>show system snat nat-loopback</code>	Displays activated activated NAT rules which use SNAT with NAT loopback enabled.
<code>show system snat default-snat</code>	Displays the default WAN trunk settings.

## 70.3 Packet Flow Explore Commands Example

The following example shows all routing related functions and their order.

```
Router> show route order
route order: Policy Route, Direct Route, 1-1 SNAT, SiteToSite VPN, Dynamic
VPN, Static-Dynamic Route, Default WAN Trunk, Main Route
```

The following example shows all SNAT related functions and their order.

```
Router> show system snat order
snat order: Policy Route SNAT, 1-1 SNAT, Loopback SNAT, Default SNAT
```

The following example shows all SNAT related functions and their order.

```
Router> show system route policy-route
No.  PR NO.  Source  Destination  Incoming  DSCP  Service  Nexthop
Type           Nexthop Info
=====
```

The following example shows all activated 1-to-1 SNAT rules.

```
Router> show system route nat-1-1
No.  VS Name  Source  Destination  Outgoing  Gateway
=====
```

The following example shows all activated site-to-site VPN rules.

```
Router> show system route site-to-site-vpn
No.  Source  Destination  VPN Tunnel
=====
```

The following example shows all activated dynamic VPN rules.

```
Router> show system route dynamic-vpn
No.  Source  Destination  VPN Tunnel
=====
```

The following example shows the default WAN trunk's settings.

```
Router> show system route default-wan-trunk
No.  Source  Destination  Trunk
=====
1    any    any          trunk_ex
```

The following example shows all activated dynamic VPN rules.

```
Router> show system route dynamic-vpn
No.  Source          Destination          VPN Tunnel
=====
```

The following example shows all activated static-dynamic VPN rules.

```
Router> show ip route static-dynamic
Flags: A - Activated route, S - Static route, C - directly Connected
       O - OSPF derived, R - RIP derived, G - selected Gateway
       ! - reject, B - Black hole, L - Loop

IP Address/Netmask  Gateway          IFace          Metric  Flags
Persist
=====
0.0.0.0/0           10.1.1.254      wan1           0       ASG    -
```

The following example shows all activated policy routes which use SNAT.

```
Router> show system snat policy-route
No.  PR NO.  Outgoing          SNAT
=====
```

The following example shows all activated 1-to-1 NAT rules.

```
Router> show system snat nat-1-1
No.  VS Name  Source          Destination  Outgoing          SNAT
=====
```

The following example shows all activated policy routes which use SNAT and enable NAT loopback..

```
Router> show system snat nat-loopback
Note: Loopback SNAT will be only applied only when the initiator is located
at the network which the server locates at

No.  VS Name  Source          Destination  SNAT
=====
```

The following example shows all activated 1-to-1 NAT rules.

```
Router> show system snat nat-1-1
No.  VS Name  Source          Destination  Outgoing          SNAT
=====
```

The following example shows the default WAN trunk settings.

```
Router> show system snat default-snat
Incoming          Outgoing          SNAT
=====
Internal Interface      External Interface      Outgoing Interface IP

Internal Interfaces: lan1, hidden, lan2, dmz
External Interfaces: wan1, wan2, wan1_ppp, wan2_ppp
Router>
```



# CHAPTER 71

## Maintenance Tools

Use the maintenance tool commands to optimize the health of the Zyxel Device, check the status of other devices connected to the Zyxel Device, and troubleshoot network problems..

Table 326 Maintenance Tools Commands in Privilege Mode

COMMAND	DESCRIPTION
<pre>packet-trace [interface interface_name] [[ip-proto ipv6- proto]   protocol_name   any]] [src-host {ip   hostname   any}] [dst-host {ip   hostname   any}] [port &lt;1..65535&gt;   any]] [file] [duration &lt;1..3600&gt;] [extension- filter filter_extension]</pre>	<p>Sniffs traffic going through the specified interface with the specified protocol, source address, destination address, and/or port number.</p> <p>If you specify <code>file</code>, the Zyxel Device dumps the traffic to <code>/packet_trace/packet_trace_interface</code>. Use FTP to retrieve the files (see <a href="#">Section 65.7 on page 531</a>).</p> <p>If you do not assign the duration, the Zyxel Device keeps dumping traffic until you use Ctrl-C.</p> <p>Use the extension filter to extend the use of this command.</p> <p><i>protocol_name</i>: You can use the name, instead of the number, for some IP protocols, such as <code>tcp</code>, <code>udp</code>, <code>icmp</code>, and so on. The names consist of 1-16 alphanumeric characters or dashes (-). The first character cannot be a number.</p> <p><i>hostname</i>: You can use up to 252 alphanumeric characters, dashes (-), or periods (.). The first character cannot be a period.</p> <p><i>filter_extension</i>: You can use 1-256 alphanumeric characters, spaces, or '()+,/:=?!*#@\$%_- characters.</p>
<pre>traceroute {ip   hostname}</pre>	<p>Displays the route taken by packets to the specified destination. Use Ctrl+C to return to the prompt.</p>
<pre>traceroute6 {ipv6   hostname}</pre>	<p>Displays the route taken by packets to the specified destination. Use Ctrl+C to return to the prompt.</p>
<pre>[no] packet-capture activate</pre>	<p>Performs a packet capture that captures network traffic going through the set interface(s). Studying these packet captures may help you identify network problems.</p> <p>The <code>no</code> command stops the running packet capture on the Zyxel Device.</p> <p>Note: Use the <code>packet-capture configure</code> command to configure the packet-capture settings before using this command.</p>
<pre>packet-capture configure</pre>	<p>Enters the sub-command mode.</p>
<pre>duration &lt;0..300&gt;</pre>	<p>Sets a time limit in seconds for the capture. The Zyxel Device stops the capture and generates the capture file when either this period of time has passed or the file reaches the size specified using the <code>files-size</code> command below. 0 means there is no time limit.</p>

Table 326 Maintenance Tools Commands in Privilege Mode (continued)

COMMAND	DESCRIPTION
<code>file-suffix &lt;profile_name&gt;</code>	Specifies text to add to the end of the file name (before the dot and filename extension) to help you identify the packet capture files. Modifying the file suffix also avoids making new capture files that overwrite existing files of the same name.  The file name format is "interface name-file suffix.cap", for example "vlan2-packet-capture.cap".
<code>files-size &lt;1..10000&gt;</code>	Specify a maximum size limit in megabytes for the total combined size of all the capture files on the ZyWALL, including any existing capture files and any new capture files you generate.  The Zyxel Device stops the capture and generates the capture file when either the file reaches this size or the time period specified (using the <code>duration</code> command above) expires.
<code>host-ip {ip-address   profile_name   any}</code>	Sets a host IP address or a host IP address object for which to capture packets. <code>any</code> means to capture packets for all hosts.
<code>host-port &lt;0..65535&gt;</code>	If you set the IP Type to <code>any</code> , <code>tcp</code> , or <code>udp</code> using the <code>proto-type</code> command below, you can specify the port number of traffic to capture.
<code>iface {add   del} {interface_name   virtual_interface_name}</code>	Adds or deletes an interface or a virtual interface for which to capture packets to the capture interfaces list.
<code>ip-version {ip ip6 any}</code>	Sets whether to capture IPv4 or IPv6 traffic. <code>Any</code> means to capture packets for all types of traffic.
<code>proto-type {icmp   icmp6   igmp   igrp   pim   ah   esp   vrrp   udp   tcp   any}</code>	Sets the protocol of traffic for which to capture packets. <code>any</code> means to capture packets for all types of traffic.
<code>snaplen &lt;68..1512&gt;</code>	Specifies the maximum number of bytes to capture per packet. The Zyxel Device automatically truncates packets that exceed this size. As a result, when you view the packet capture files in a packet analyzer, the actual size of the packets may be larger than the size of captured packets.
<code>storage &lt;internal usbstorage&gt;</code>	Sets to have the Zyxel Device only store packet capture entries on the Zyxel Device (internal) or on a USB storage connected to the Zyxel Device.
<code>ring-buffer &lt;enable disable&gt;</code>	Enables or disables the ring buffer used as a temporary storage.
<code>split-size &lt;1..2048&gt;</code>	Specify a maximum size limit in megabytes for individual packet capture files. After a packet capture file reaches this size, the Zyxel Device starts another packet capture file.
<code>Ping {ipv4   hostname} [source ipv4] [size &lt;0..65507&gt;] [forever count &lt;1..4096&gt;]</code>	Sends an ICMP ECHO_REQUEST to test the reachability of a host on an IPv4 network and to measure the round-trip time for a message sent from the originating host to the destination computer.  <code>size</code> : specifies the number of data bytes to be sent  <code>count</code> : Stop after sending this number of ECHO_REQUEST packets.  <code>forever</code> : keep sending ECHO_REQUEST packets until you use Ctrl+c to stop.

Table 326 Maintenance Tools Commands in Privilege Mode (continued)

COMMAND	DESCRIPTION
<pre>ping {ipv4_addr   hostname} [source ipv4] [size &lt;0..65507&gt;] [forever   count &lt;1..4096&gt;] [interface interface_name] [extension filter- extension]</pre>	<p>Sends an ICMP ECHO_REQUEST to test the reachability of a host on an IPv4 network and to measure the round-trip time for a message sent from the originating host to the destination computer.</p> <p>Use the extension filter to extend the use of this command.</p> <p><i>source</i>: Set source address to specified interface IPv4 address.</p> <p><i>size</i>: specifies the number of data bytes to be sent.</p> <p><i>count</i>: Stop after sending this number of ECHO_REQUEST packets.</p> <p><i>forever</i>: keep sending ECHO_REQUEST packets until you use Ctrl+c to stop.</p> <p><i>interface_name</i>: specifies interface through which to send the ECHO_REQUEST packets.</p> <p><i>filter_extension</i>: You can use 1-256 alphanumeric characters, spaces, or '()+,/:=?!*#@\$%_- characters.</p>
<pre>ping6 {ipv6   hostname} [source ipv6] [size &lt;0..65527&gt;] [forever   count &lt;1..4096&gt;] [interface {interface_name   virtual_interface_name}] [extension filter_extension]</pre>	<p>Sends an ICMP ECHO_REQUEST to test the reachability of a host on an IPv6 network and to measure the round-trip time for a message sent from the originating host to the destination computer.</p> <p>Use the extension filter to extend the use of this command.</p> <p><i>source</i>: Set source address to specified interface IPv6 address. When pinging IPv6 link-local address this option is required.</p> <p><i>size</i>: specifies the number of data bytes to be sent</p> <p><i>count</i>: Stop after sending this number of ECHO_REQUEST packets.</p> <p><i>forever</i>: keep sending ECHO_REQUEST packets until you use Ctrl+c to stop.</p> <p><i>interface_name</i>: specifies interface through which to send the ECHO_REQUEST packets.</p> <p><i>filter_extension</i>: You can use 1-256 alphanumeric characters, spaces, or '()+,/:=?!*#@\$%_- characters.</p>
<pre>traceroute {ipv4   hostname} [source ipv4] [interface interface_name] [extension filter- extension]</pre>	<p>Displays the route packets take to an IPv4 network host.</p> <p>Use the extension filter to extend the use of this command.</p> <p><i>source</i>: Set source address to specified interface IPv4 address.</p> <p><i>interface_name</i>: specifies a network interface to obtain the source IP address for outgoing probe packets.</p> <p><i>filter_extension</i>: You can use 1-256 alphanumeric characters, spaces, or '()+,/:=?!*#@\$%_- characters.</p>

Table 326 Maintenance Tools Commands in Privilege Mode (continued)

COMMAND	DESCRIPTION
<code>traceroute6 {ipv6   hostname} [source ipv6] [interface interface_name] [extension filter- extension]</code>	Displays the route packets take to an IPv6 network host.  Use the extension filter to extend the use of this command.  <i>source</i> : Set source address to specified interface IPv6 address.  <i>interface_name</i> : specifies a network interface to obtain the source IP address for outgoing probe packets.  <i>filter_extension</i> : You can use 1-256 alphanumeric characters, spaces, or '()+,/:=?!*#@\$_%.- characters.
<code>tracpath6 {ipv6   hostname}</code>	Displays the path MTU for the target address.
<code>show packet-capture status</code>	Displays whether a packet capture is ongoing.
<code>show ipv6 neighbor-list</code>	Displays the Zyxel Device's IPv6 neighbors.
<code>show packet-capture config</code>	Displays current packet capture settings.

Here are maintenance tool commands that you can use in configuration mode.

Table 327 Maintenance Tools Commands in Configuration Mode

COMMAND	DESCRIPTION
<code>ipv6 neighbor flush {ipv6   all}</code>	Clears the specified IPv6 address or all IPv6 addresses from the IPv6 neighbor cache.

## 71.1 Maintenance Command Examples

Some packet-trace command examples are shown below.

```
Router# packet-trace duration 3
tcpdump: listening on eth0
19:24:43.239798 192.168.1.10 > 192.168.1.1: icmp: echo request
19:24:43.240199 192.168.1.1 > 192.168.1.10: icmp: echo reply
19:24:44.258823 192.168.1.10 > 192.168.1.1: icmp: echo request
19:24:44.259219 192.168.1.1 > 192.168.1.10: icmp: echo reply
19:24:45.268839 192.168.1.10 > 192.168.1.1: icmp: echo request
19:24:45.269238 192.168.1.1 > 192.168.1.10: icmp: echo reply

6 packets received by filter
0 packets dropped by kernel
```

```

Router# packet-trace interface ge2 ip-proto icmp file extension-filter -s
-> 500 -n
tcpdump: listening on eth1
07:24:07.898639 192.168.105.133 > 192.168.105.40: icmp: echo request (DF)
07:24:07.900450 192.168.105.40 > 192.168.105.133: icmp: echo reply
07:24:08.908749 192.168.105.133 > 192.168.105.40: icmp: echo request (DF)
07:24:08.910606 192.168.105.40 > 192.168.105.133: icmp: echo reply

8 packets received by filter
0 packets dropped by kernel

```

```

Router# packet-trace interface ge2 ip-proto icmp file extension-filter
-> and src host 192.168.105.133 and dst host 192.168.105.40 -s 500 -n
tcpdump: listening on eth1
07:26:51.731558 192.168.105.133 > 192.168.105.40: icmp: echo request (DF)
07:26:52.742666 192.168.105.133 > 192.168.105.40: icmp: echo request (DF)
07:26:53.752774 192.168.105.133 > 192.168.105.40: icmp: echo request (DF)
07:26:54.762887 192.168.105.133 > 192.168.105.40: icmp: echo request (DF)

8 packets received by filter
0 packets dropped by kernel

```

```

Router# traceroute www.zyxel.com
traceroute to www.zyxel.com (203.160.232.7), 30 hops max, 38 byte packets
 1  172.23.37.254  3.049 ms  1.947 ms  1.979 ms
 2  172.23.6.253  2.983 ms  2.961 ms  2.980 ms
 3  172.23.6.1  5.991 ms  5.968 ms  6.984 ms
 4  * * *

```

Here are maintenance tool commands that you can use in configure mode.

Table 328 Maintenance Tools Commands in Configuration Mode

COMMAND	DESCRIPTION
show arp-table	Displays the current Address Resolution Protocol table.
arp IP <i>mac_address</i>	Edits or creates an ARP table entry.
no arp <i>ip</i>	Removes an ARP table entry.

The following example creates an ARP table entry for IP address 192.168.1.10 and MAC address 01:02:03:04:05:06. Then it shows the ARP table and finally removes the new entry.

```
Router# arp 192.168.1.10 01:02:03:04:05:06
Router# show arp-table
Address                HWtype  HWaddress           Flags Mask            Iface
192.168.1.10          ether   01:02:03:04:05:06   CM                    ge1
172.23.19.254         ether   00:04:80:9B:78:00   C                     ge2
Router# no arp 192.168.1.10
Router# show arp-table
Address                HWtype  HWaddress           Flags Mask            Iface
192.168.1.10          (incomplete)
172.23.19.254         ether   00:04:80:9B:78:00   C                     ge2
```

### 71.1.1 Packet Capture Command Example

The following examples show how to configure packet capture settings to capture packets going through the Zyxel Device WAN1 interface only.

Use **Split Size** to specify a maximum size for individual packet capture files. After a packet capture file reaches this size, the Zyxel Device starts another packet capture file.

Use **File Size** to specify a maximum size limit for the total combined size of all the capture files on the Zyxel Device, including any existing capture files and any new capture files you generate.

Use **Duration** to set a limit in seconds for the capture. The Zyxel Device stops the capture and generates the capture file when either this period of time has passed or when the file reaches the **File Size** limit you specify.

Enable **Ring Buffer** to continuously capture and overwrite old files until you stop capturing packets manually. The Zyxel Device will not stop even if the **File Size** limit you specify is reached. You should specify the **File Size** limit to a larger number or delete existing captured files if you disable this feature.

This example follows the parameters in the list below.

- IP address: any
- Host IP: any
- Host Port: any (then you do not need to configure this setting)
- File Suffix: Example
- Split Size: 10 megabytes
- File Size: 100 megabytes
- Duration: 150 seconds
- Save the captured packets to: USB storage device
- Ring Buffer: Enable

- 1 Check if there's any packet capture running on the Zyxel Device.

```
Router(config)# show packet-capture status
```

- 2 Check the current packet capture settings.

```
Router(config)# show packet-capture config
iface: None
ip-version: any
proto-type: any
host-port: 0
host-ip: any
file-suffix: -packet-capture
snaplen: 1500
duration: 0
file-size: 10
split-size: 2
ring-buffer: 0
storage: 0
```

- 3 Enter packet capture sub-command mode to configure settings to capture traffic that goes through the specific interface.

```
Router(config)# packet-capture configure
Router(packet-capture)#
```

- 4 Configure the packet capture settings according to the list above.

```
Router(packet-capture)# iface add wan1
Router(packet-capture)# ip-type any
Router(packet-capture)# host-ip any
Router(packet-capture)# file-suffix Example
Router(packet-capture)# files-size 100
Router(packet-capture)# duration 150
Router(packet-capture)# storage usbstorage
Router(packet-capture)# ring-buffer enable
Router(packet-capture)# split-size 10
Router(packet-capture)#
```

- 5 Exit the sub-command mode. Activate packet capture to have the Zyxel Device capture packets according to the settings you just configured.

```
Router(packet-capture)# exit
Router(config)# packet-capture activate
Router(config)#
```

- 6 Manually stop the running packet capturing when you get the information you need. Otherwise, with **Ring Buffer** enabled, the Zyxel Device will keep capturing and overwriting old captured files.

```
Router(config)# no packet-capture activate
Router(config)#
```

- 7 Check current packet capture status and list all stored packet captures.

```
Router(config)# show packet-capture status
capture status: off
Router(config)# dir /packet_trace
File Name                               Size      Modified Time
=====
wan1-Example.cap                        575160    2009-11-24 09:06:59
Router(config)#
```

- 8 Download the captured files in the web configurator at **Maintenance > Diagnostics > Packet Capture > Files**. Open and study it using a packet analyzer tool (for example, Ethereal or Wireshark).

## 71.2 Scheduled Reboot

For stability, you can restart the Zyxel Device periodically according to a user-defined schedule.



## 71.2.1 High Availability Reboot Process

Figure 68 High Availability Reboot Process Flow

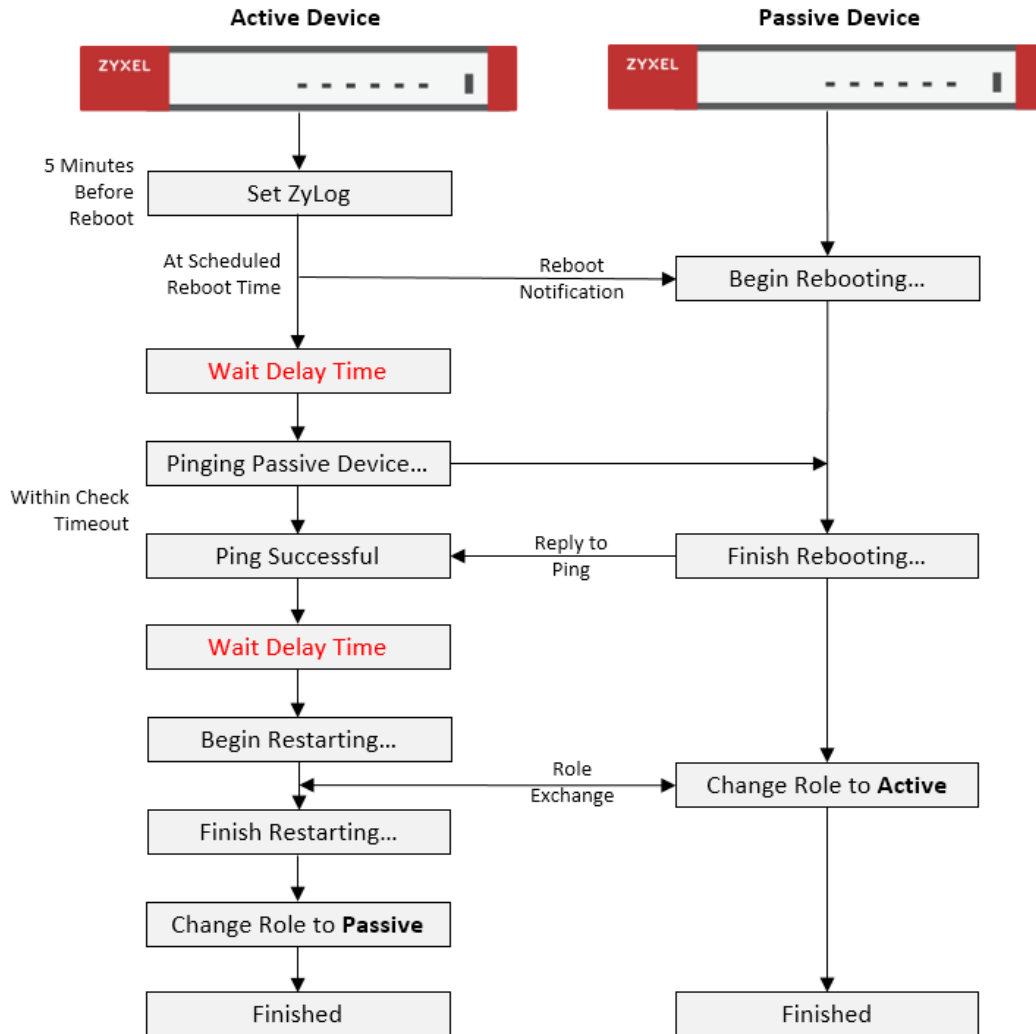

The following table describes the schedule reboot commands.

Table 329 Scheduled Reboot Commands

COMMAND	DESCRIPTION
[no] schedule reboot activate	Enables or disables the reboot schedule. When enabled, the Zyxel Device will restart according to the schedule.
schedule reboot daily <time, hh:mm>	Sets the device to restart once a day at the specified hour and minute.  hh:mm is in 24-hour format, for example 23:30.
schedule reboot weekly <time, hh:mm> {sun/mon/tue/wed/thu/fri/sat}	Sets the device to restart once a week on the specified day, at the specified hour and minute.  hh:mm is in 24-hour format, for example 23:30.
schedule reboot monthly <time, hh:mm> <day, dd>	Sets the device to restart once a month on the specified day, at the specified hour and minute.  dd must be written as two digits. The valid range is 01–28.

Table 329 Scheduled Reboot Commands (continued)

COMMAND	DESCRIPTION
<code>device-ha2 schedule-reboot check-timeout &lt;1..3600&gt;</code>	Sets how long the active device pings the passive device for, in seconds, after the passive device has restarted. If the passive device does not respond within the specified time, the activate device cancels the scheduled reboot.  The default time is 1800 seconds.
<code>device-ha2 schedule-reboot delay &lt;1..300&gt;</code>	Sets a delay time to ensure the passive device has sufficient time to shut down and start up. The delay time is measured in seconds, and the default is 10.  After the passive device shuts down, the active device waits for the specified delay time before starting to ping the passive device. Then after the ping is successful, the activate device waits for the specified delay time before rebooting.
<code>show schedule reboot status</code>	Displays the status of the reboot schedule, including whether it is active and at what time and date the device is scheduled to reboot.
<code>show device-ha2 schedule-reboot check-timeout</code>	Displays the ping timeout time, in seconds.
<code>show device-ha2 schedule-reboot delay</code>	Displays the HA reboot delay time, in seconds.

## 71.3 Configuration File Backup

You can back up the Zyxel Device's configuration file, by downloading it to your local computer or by sending it to an email address.

Table 330 Configuration File Backup Commands

COMMAND	DESCRIPTION
The <code>conf-mail</code> commands send a user-specified configuration file immediately to an email address.	
<code>conf-mail mail-subject &lt;subject&gt;</code>	Sets the backup email subject text.  The text must be 1–60 characters, and may consist of letters, numbers, and the following special characters: '()+,./ :=?;!*#@\$_%'-
<code>conf-mail mail-content &lt;mail-content&gt;</code>	Sets the backup email body text.  The text must consist of 1–250 ASCII characters.
<code>conf-mail no mail-content</code>	Clears the backup email body text.
<code>conf-mail {mail-to-1/mail-to-2/mail-to-3/mail-to-4/mail-to-5} &lt;user@domainname&gt;</code>	Sets the receiving email address.  You can send the configuration file to a maximum of five email addresses.
<code>conf-mail no {mail-to-1/mail-to-2/mail-to-3/mail-to-4/mail-to-5}</code>	Clears the receiving email address.
<code>conf-mail attach password &lt;attachment password&gt;</code>	Adds an encryption password to the configuration file in the email.  The password must consist of 1–31 ASCII characters.

Table 330 Configuration File Backup Commands (continued)

COMMAND	DESCRIPTION
<code>conf-mail send-now &lt;configfile&gt;</code>	Sends the specified configuration file to the configured email addresses.  <CONFIGFILE> must contain a full file path, for example: /conf/system-default.conf
<code>show config-backup status</code>	Shows the backup mail settings.
The <code>conf-backup</code> commands automatically backup the current Zyxel Device configuration file according to a schedule, and then send it to an email address.	
<code>config-backup setting</code>	Enters the configuration file scheduled backup subcommand mode.
<code>mail-attach password &lt;attachment password&gt;</code>	Adds an encryption password to the configuration file in the email.  The password must consist of 1–31 ASCII characters.
<code>no mail-attach password</code>	Removes the encryption password from the email.
<code>mail-info content &lt;mail-content&gt;</code>	Sets the backup email body text.  The text must consist of 1–250 ASCII characters.
<code>no mail-info content</code>	Clears the backup email body text.
<code>mail-info {mail-to-1/mail-to-2/mail-to-3/mail-to-4/mail-to-5} &lt;user@domainname&gt;</code>	Sets the receiving email address.  You can send the configuration file to a maximum of five email addresses.
<code>no {mail-to-1/mail-to-2/mail-to-3/mail-to-4/mail-to-5}</code>	Clears the receiving email address.
<code>[no] mail-send</code>	The Zyxel Device backs up the current configuration file, and then sends it to the configured email addresses.  With the <code>[no]</code> option, the Zyxel Device only backs up the current configuration file.
<code>scheduler daily &lt;time, hh:mm&gt;</code>	Sets the device to backup its config file once a day at the specified hour and minute.  <i>hh:mm</i> is in 24-hour format, for example 23:30.
<code>scheduler weekly &lt;time, hh:mm&gt; {sun/mon/tue/wed/thu/fri/sat}</code>	Sets the device to backup its config file once a week on the specified day, at the specified hour and minute.  <i>hh:mm</i> is in 24-hour format, for example 23:30.
<code>scheduler monthly &lt;time, hh:mm&gt; &lt;day, dd&gt;</code>	Sets the device to backup its config file once a month on the specified day, at the specified hour and minute.  <i>dd</i> must be written as two digits. The valid range is 01–31. If the day is greater than the number of days in the month, then the job will run on the last day of the month.
<code>exit</code>	Exits subcommand mode.
<code>[no] config-backup scheduler activate</code>	Enables or disables the automatic configuration file backup.
<code>config-backup run</code>	Backups up the configuration file now.
<code>show config-backup status</code>	Shows the schedules configuration file backup settings.

# CHAPTER 72

## Miscellaneous

### 72.1 SDWAN OnCloud

From firmware version 5.0 and later, certain models of Zyxel Device can be managed by Nebula Control Center (NCC).

Table 331 SDWAN Commands

COMMAND	DESCRIPTION
<code>show sdwan oncloudst</code>	Displays whether NCC is managing the Zyxel Device.

### 72.2 Watchdog Timer

This section provides information about the Zyxel Device's watchdog timers.

#### 72.2.1 Hardware Watchdog Timer

The hardware watchdog has the system restart if the hardware fails.

**The `hardware-watchdog-timer` commands are for support engineers. It is recommended that you not modify the hardware watchdog timer settings.**

Table 332 hardware-watchdog-timer Commands

COMMAND	DESCRIPTION
<code>[no] hardware-watchdog-timer &lt;4..37&gt;</code>	Sets how long the system's hardware can be unresponsive before resetting. The <code>no</code> command turns the timer off.
<code>show hardware-watchdog-timer status</code>	Displays the settings of the hardware watchdog timer.

#### 72.2.2 Software Watchdog Timer

The software watchdog has the system restart if the core firmware fails.

**The `software-watchdog-timer` commands are for support engineers. It is recommended that you not modify the software watchdog timer settings.**

Table 333 software-watchdog-timer Commands

COMMAND	DESCRIPTION
[no] software-watchdog-timer <10..600>	Sets how long the system's core firmware can be unresponsive before resetting. The no command turns the timer off.
show software-watchdog-timer status	Displays the settings of the software watchdog timer.
show software-watchdog-timer log	Displays a log of when the software watchdog timer took effect.

### 72.2.3 Application Watchdog

The application watchdog has the system restart a process that fails. These are the `app-watchdog` commands. Use the `configure terminal` command to enter the configuration mode to be able to use these commands.

Table 334 app-watchdog Commands

COMMAND	DESCRIPTION
[no] app-watch-dog activate	Turns the application watchdog timer on or off.
[no] app-watch-dog auto-recover	If app-watch-dog detects a dead process, app-watch-dog will try to auto-recover. The no command turns off auto-recover
[no] app-watch-dog console-print {always once}	Display debug messages on the console (every time they occur or once). The no command changes the setting back to the default.
[no] app-watch-dog cpu-threshold min <1..100> max <1..100>	Sets the percentage thresholds for sending a CPU usage alert. The Zyxel Device starts sending alerts when CPU usage exceeds the maximum (the second threshold you enter). The Zyxel Device stops sending alerts when the CPU usage drops back below the minimum threshold (the first threshold you enter). The no command changes the setting back to the default.
[no] app-watch-dog interval <6..300>	Sets how frequently (in seconds) the Zyxel Device checks the system processes. The no command changes the setting back to the default.
[no] app-watch-dog retry-count <1..5>	Set how many times the Zyxel Device is to re-check a process before considering it failed. The no command changes the setting back to the default.
[no] app-watch-dog alert	Has the Zyxel Device send an alert the user when the system is out of memory or disk space.
[no] app-watch-dog disk-threshold min <1..100> max <1..100>	Sets the percentage thresholds for sending a disk usage alert. The Zyxel Device starts sending alerts when disk usage exceeds the maximum (the second threshold you enter). The Zyxel Device stops sending alerts when the disk usage drops back below the minimum threshold (the first threshold you enter). The no command changes the setting back to the default.
[no] app-watch-dog mem-threshold min <1..100> max <1..100>	Sets the percentage thresholds for sending a memory usage alert. The Zyxel Device starts sending alerts when memory usage exceeds the maximum (the second threshold you enter). The Zyxel Device stops sending alerts when the memory usage drops back below the minimum threshold (the first threshold you enter). The no command changes the setting back to the default.

Table 334 app-watchdog Commands

COMMAND	DESCRIPTION
<code>app-watch-dog reboot-log flush</code>	Flushes the reboot log record.
<code>[no] app-watch-dog sys-reboot</code>	If auto recover fail reaches the maximum retry count, app-watch-dog reboots the device. The <code>no</code> command turns off system auto reboot.
<code>show app-watch-dog config</code>	Displays the application watchdog timer settings.
<code>show app-watch-dog monitor-list</code>	Display the list of applications that the application watchdog is monitoring.
<code>show app-watch-dog reboot-log</code>	Displays the application watchdog reboot log.

### 72.2.3.1 Application Watchdog Commands Example

The following example displays the application watchdog configuration and lists the processes that the application watchdog is monitoring.

```

Application Watch Dog Setting:
activate: yes
alert: yes
console print: always
retry count: 3
auto recover: yes
system reboot: yes
interval: 60 seconds
mem threshold: 80% ~ 90%
cpu threshold: 80% ~ 90%
disk threshold: 80% ~ 90%
Router(config)# show app-watch-dog monitor-list
#app_name min_process_count max_process_count(-1 unlimited) recover_enable recover_reboot recover_always recover_max_try_count recover_max_fail_count
usamd 1 1 0 1 1 1 1 3
firewall 1 1 0 1 1 1 1 3
policyd 1 1 0 1 1 1 1 3
confld 1 1 0 1 1 1 1 3
classify 1 1 0 1 1 1 1 3
ospfd 1 1 0 1 1 1 1 3
ripd 1 1 0 1 1 1 1 3
resd 1 1 0 1 1 1 1 3
zyshd_wd 1 1 0 1 1 1 1 3
zyshd 1 1 0 0 1 1 1 3
htcpd 1 1 0 1 1 1 1 3
dnhcpd 1 1 0 1 1 1 1 3
sshpscpm 1 1 0 1 1 1 1 3
zylogd 1 1 0 1 1 1 1 3
syslog-ng 1 1 0 1 1 1 1 3
zylogger 1 1 0 1 1 1 1 3
dnsm_dad 1 1 0 1 1 1 1 3
tpd 1 1 0 1 1 1 1 3
wtd 1 1 0 1 1 1 1 3
zebra 1 1 0 1 1 1 1 3
link_updown 1 1 0 1 1 1 1 3
fauthd 1 1 0 1 1 1 1 3
pro 1 1 0 1 1 1 1 3
signal_wrapper 1 1 0 1 1 1 1 3
asd 1 1 0 1 1 1 1 3
ctipd.bin 1 1 1 1 1 1 1 3
ipmonitor 1 1 0 1 1 1 1 3
  
```

## 72.3 Conserve Memory

The Zyxel Device throughput may be slow if dynamic memory usage is reaching a maximum. Conserve Memory allows Zyxel Device to free up memory by omitting certain security scans.

Note: Enabling this feature is not recommended, as it might reduce the security of your network.

Conserve Memory is supported on ZyWALL USG (Unified Security Gateway) models only. This does not include USG FLEX models. For a full list of USG models, see [Section 1.1 on page 25](#).

### 72.3.1 Conserve Memory Settings

To conserve dynamic memory, enable one or both of the following settings:

- **AV Cloud Query Bypass:** Traffic passing through the Zyxel Device is not scanned by Anti-Virus (express mode).
- **UTM Features Bypass:** Traffic passing through the Zyxel Device is not scanned by the following services: IDP, ADP, App Patrol, Anti-Virus (stream mode).

### 72.3.2 Conserve Memory Commands

The following table lists the Conserve Memory commands.

Table 335 Conserve Memory Commands

COMMAND	DESCRIPTION
<code>show mem-conserve status</code>	Displays all Conserve Memory settings.
<code>[no] mem-conserve activate</code>	Enables or disables the Conserve Memory feature.
<code>[no] mem-conserve av-bypass falling-threshold &lt;1..4000&gt;</code>	Sets the on threshold for AV Cloud Query Bypass, in Megabytes (MB). When the available memory of the Zyxel Device is equal to this value, the Zyxel Device enables AV Cloud Query Bypass mode.
<code>[no] mem-conserve av-bypass rising-threshold &lt;1..4000&gt;</code>	Sets the off threshold for AV Cloud Query Bypass, in Megabytes (MB). When the available memory of the Zyxel Device is equal to this value, the Zyxel Device disables AV Cloud Query Bypass mode.
<code>[no] mem-conserve av-bypass sustained-time &lt;1..60&gt;</code>	Sets the minimum amount of time, in minutes, that AV Cloud Query Bypass stays enabled after reaching the falling threshold. If available memory reaches the rising threshold during this time period, AV Cloud Query Bypass is not disabled.
<code>[no] mem-conserve utm-bypass falling-threshold &lt;1..4000&gt;</code>	Sets the on threshold for UTM Features Bypass, in Megabytes (MB). When the available memory of the Zyxel Device is equal to this value, the Zyxel Device enables UTM Features Bypass mode.



Table 335 Conserve Memory Commands

COMMAND	DESCRIPTION
[no] mem-conserve utm-bypass rising-threshold <1..4000>	Sets the off threshold for UTM Features Bypass, in Megabytes (MB). When the available memory of the Zyxel Device is equal to this value, the Zyxel Device disables UTM Features Bypass mode.
[no] mem-conserve utm-bypass sustained-time <1..60>	Sets the minimum amount of time, in minutes, that UTM Features Bypass stays enabled after reaching the falling threshold. If available memory reaches the rising threshold during this time period, UTM Features Bypass is not disabled.

### 72.3.3 Conserve Memory Example

In this example, the Zyxel Device is set to bypass UTM security services if available memory drops to 5 MB, for a minimum of 4 seconds. The UTM security services bypass will be disabled if available memory increases to 10 MB.

Figure 69 Conserve Memory: Example

```
Router# configure terminal
Router(config)# mem-conserve utm-bypass falling-threshold 5
Router(config)# mem-conserve utm-bypass rising-threshold 10
Router(config)# mem-conserve utm-bypass sustained-time 4
```

The following figure shows the result of these commands:

Figure 70 Converse Memory Example

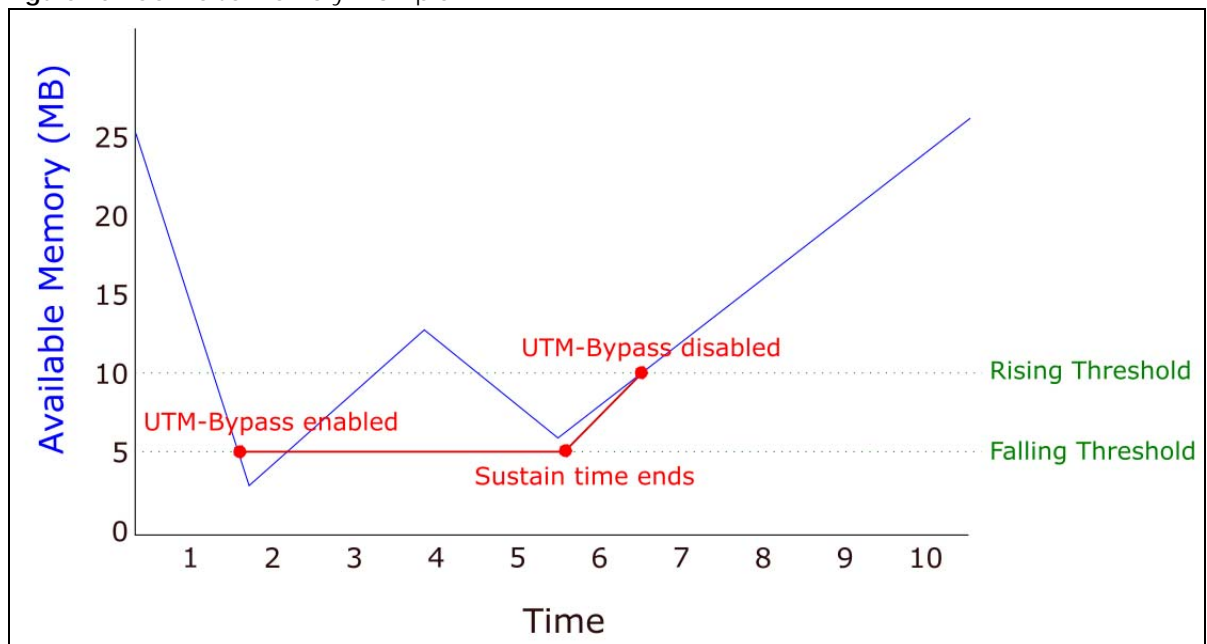

## 72.4 GUI Visibility

The GUI visibility commands show or hide advanced features in the Web Configurator.

Table 336 gui-visibility Commands

COMMAND	DESCRIPTION
[no] gui-visibility gui-visibility policy-route-fromlocal-snat	Allows you to configure Source Network Address Translation (SNAT) when Incoming interface is set to "ZyWALL" in the Web Configurator at <b>Configuration &gt; Network &gt; Routing &gt; Policy Route &gt; Add/Edit Policy Route</b> .  The <code>no</code> command prevents this setting from being configured.  Note: This command is available in ZLD firmware 5.0 and later.
[no] gui-visibility show-advanced	
show gui-visibility status	Displays the current GUI visibility settings.

# CHAPTER 73

## Managed AP Commands

Connect directly to a managed AP's CLI (Command Line Interface) to configure the managed AP's CAPWAP (Control And Provisioning of Wireless Access Points) client and DNS server settings.

### 73.1 Managed Series AP Commands Overview

Log into an AP's CLI and use the commands in this chapter if the AP does not automatically connect to the Zyxel Device or you need to configure the AP's DNS server. Use the CAPWAP client commands to configure settings to let the AP connect to the Zyxel Device. Use the DNS server commands to configure the DNS server address to which the AP connects. When the AP reboots, it only keeps the configuration from commands covered in this chapter.

### 73.2 Accessing the AP CLI

Connect to the AP's console port and use a terminal emulation program or connect through the network using Telnet or SSH. The settings and steps for logging in are similar to connecting to the Zyxel Device. See [Section 1.2 on page 26](#) for details.

Note: The AP's default login username is **admin** and password is **1234**. The username and password are case-sensitive. If the AP has connected to the Zyxel Device, the AP uses the same admin password as the Zyxel Device.

Use the `write` command to save the current configuration to the Zyxel Device.

Note: Always save the changes before you log out after each management session. All unsaved changes will be lost after the system restarts.

### 73.3 CAPWAP Client Commands

Use the CAPWAP client commands to configure the AP's IP address and other related management interface settings. Do not use the original interface commands to configure the IP address and related settings on the AP, because the AP does not save interface command settings after rebooting.

The following table identifies the values required for many of these commands. Other input values are discussed with the corresponding commands.

Table 337 Input Values for CAPWAP Client Commands

LABEL	DESCRIPTION
<i>ip</i>	IPv4 address.
<i>netmask</i>	The network subnet mask. For example, 255.255.255.0.
<i>gateway</i>	The default gateway IP address of the interface. Enter a standard IPv4 IP address (for example, 127.0.0.1).
<i>primary_ac_ap</i>	The primary IPv4 address of the Zyxel Device.
<i>secondary_ac_ap</i>	Optional IPv4 address of the Zyxel Device.
<i>vid</i>	The VLAN ID (1-4094) of the managed AP.
<i>primary_ac_dns</i>	The primary fully qualified domain name (FQDN) of the Zyxel Device.
<i>secondary_ac_dns</i>	The secondary fully qualified domain name (FQDN) of the Zyxel Device.

The following table describes commands for configuring the AP's CAPWAP client parameters, which include the management interface. You must use the `configure terminal` command to enter the configuration mode before you can use these commands.

Table 338 Command Summary: CAPWAP Client

COMMAND	DESCRIPTION
<code>capwap ap vlan ip address <i>ip netmask</i></code>	Sets the IP address and network mask of the AP's management interface.
<code>capwap ap vlan ip gateway <i>gateway</i></code>	Sets the default gateway IP address for the AP's management interface.
<code>capwap ap vlan no ip gateway</code>	Clears the default gateway IP address setting for the AP's management interface.
<code>capwap ap vlan vlan-id <i>vid</i> { tag   untag }</code>	Sets the AP's management VLAN ID as well as whether the AP sends tagged or untagged packets. The management VLAN on the Zyxel Device and AP must match for the Zyxel Device to manage the AP. The Zyxel Device's force vlan command (see <a href="#">Table 12 on page 56</a> ) takes priority over this command.
<code>capwap ap ac-ip {<i>primary_ac_ip/primary_ac_dns</i> } {<i>secondary_ac_ip/secondary_ac_dns</i> }</code>	Specifies the primary and secondary IP address or domain name of the AP controller (the Zyxel Device) to which the AP connects.
<code>capwap ap ac-ip auto</code>	Sets the AP to use DHCP to get the address of the AP controller (the Zyxel Device).
<code>show capwap ap info</code>	Displays the IP address of the Zyxel Device managing the AP and CAPWAP settings and status.
<code>show capwap ap discovery-type</code>	Displays how the AP finds the Zyxel Device.
<code>show capwap ap ac-ip</code>	Displays the address of the Zyxel Device or auto if the AP finds the Zyxel Device through broadcast packets.

### 73.3.1 CAPWAP Client Commands Example

This example shows how to configure the AP's management interface and how it connects to the AP controller (the Zyxel Device), and check the connecting status. The following commands:

- Display how the AP finds the Zyxel Device

- Set the AP's management IP address to 192.168.1.37 and netmask 255.255.255.0
- Set the AP's default gateway IP address to 192.168.1.32
- Sets the AP's management interface to use VLAN ID 2 and send tagged packets
- Specifies the primary and secondary IP addresses of the Zyxel Device (192.168.1.1 and 192.168.1.2) to which the AP connects.
- Displays the settings it configured

```

Router# configure terminal
Router(config)# show capwap ap discovery-type
Discovery type : Broadcast
Router(config)# capwap ap vlan ip address 192.168.1.37 255.255.255.0
Router(config)# capwap ap vlan ip gateway 192.168.1.32
Router(config)# capwap ap vlan vlan-id 2 tag
Router(config)# capwap ap ac-ip 192.168.1.1 192.168.1.2
Router(config)# show capwap ap discovery-type
Discovery type : Static AC IP
Router(config)# show capwap ap ac-ip
AC IP: 192.168.1.1 192.168.1.2
Router(config)# exit
Router# show capwap ap info
      AC-IP                192.168.1.1
Discovery type            Static AC IP
      SM-State              RUN(8)
      msg-buf-usage         0/10 (Usage/Max)
      capwap-version        10118
      Radio Number          1/4 (Usage/Max)
      BSS Number            8/8 (Usage/Max)
      IANA ID                037a
      Description            AP-0013499999FF

```

## 73.4 DNS Server Commands

The following table describes commands for configuring the AP's DNS server. You must use the `configure terminal` command to enter the configuration mode before you can use these commands.

Table 339 Command Summary: DNS Server

COMMAND	DESCRIPTION
<pre>ip dns server zone-forwarder {&lt;1..32&gt; append insert &lt;1..32&gt;} {domain_zone_name *} {interface interface_name   user-defined ipv4_address [interface {interface_name   auto}]}</pre>	<p>Sets a domain zone forwarder record that specifies a fully qualified domain name. You can also use an asterisk (*) if all domain zones are served by the specified DNS server(s).</p> <p><i>domain_zone_name</i>: This is a domain zone, not a host. For example, <code>zyxel.com.tw</code> is the domain zone for the <code>www.zyxel.com.tw</code> fully qualified domain name. So whenever the Zyxel Device receives needs to resolve a <code>zyxel.com.tw</code> domain name, it can send a query to the recorded name server IP address.</p> <p><i>interface_name</i>: This is the interface through which the ISP provides a DNS server. The interface should be activated and set to be a DHCP client.</p> <p><i>auto</i>: any interface that the Zyxel Device uses to send DNS queries to a DNS server according to the routing rule.</p>
<pre>ip dns server zone-forwarder move &lt;1..32&gt; to &lt;1..32&gt;</pre>	Changes the index number of a zone forwarder record.
<pre>no ip dns server zone-forwarder &lt;1..4&gt;</pre>	Removes the specified zone forwarder record.

### 73.4.1 DNS Server Commands Example

This example configures the AP to connect to the AP controller (the Zyxel Device) by DNS. The following commands:

- Set the AP's management IP address to 192.168.1.100 and netmask 255.255.255.0
- Sets the AP's management interface to use VLAN ID 3
- Set the AP's default gateway IP address to 192.168.1.1
- Add a domain zone forwarder record that specifies a DNS server's IP address of 10.1.1.1 and uses the bridge 0 interface to send queries to that DNS server
- Set the AP controller's primary domain name as `capwap-server.zyxel.com` and secondary domain name as `capwap.test.com`

```
Router(config)# capwap ap vlan ip address 192.168.1.100 255.255.255.0
Router(config)# capwap ap vlan vlan-id 3
Router(config)# capwap ap vlan ip gateway 192.168.1.1
Router(config)# ip dns server zone-forwarder append * user-defined 10.1.1.1
interface br0
Router(config)# capwap ap ac-ip capwap-server.zyxel.com capwap.test.com
```

### 73.4.2 DNS Server Commands and DHCP

The AP in the example in [Section 73.4.1 on page 590](#) uses a static IP address. If the AP uses DHCP instead, you do not need to configure the DNS server's IP address on the AP when you configure DHCP

option 6 on the DHCP server. For the example in [Section 73.4.1 on page 590](#), you would just need to configure the management interface's VLAN ID (`capwap ap vlan vlan-id 3`).

# List of Commands (Alphabetical)

This section lists the commands and sub-commands in alphabetical order. Commands and subcommands appear at the same level.

.....	132
.....	197
.....	288
.....	363
.....	405
ap internal-auth shared-secret key .....	59
geo-ip [no] geography <country_code> all address {ipv4   ip6} .....	451
(no) bootfile-name <filename> .....	127
(no) bootp-server <w.x.y.z> .....	127
(no) cnm-agent enable-cnm-id .....	237
(no) remote-assistance activate .....	563
[isakmp_algo] .....	282
[isakmp_algo] .....	283
[no] logging mail <1..2> tls authenticate-server .....	552
[no] {ipv4   ipv4_cidr   ipv4_range   wildcard_domainname   tld   ipv6   ipv6_range   ipv6_prefix } 361 .....	
[no] {ipv4   ipv4_cidr   ipv4_range   wildcard_domainname   top_level_domain} .....	326
[no] 2g-scan-channel wireless_channel_2g .....	82
[no] 5g-scan-channel wireless_channel_5g .....	83
[no] 8021x-ss0 .....	249
[no] aaa authentication profile-name .....	465
[no] aaa group server ad group-name .....	460
[no] aaa group server ldap group-name .....	462
[no] aaa group server radius group-name .....	463
[no] access-page color-window-background .....	497
[no] access-page message-text message .....	497
[no] account {pppoe   pptp} profile_name .....	484
[no] account cellular profile_name .....	485
[no] account l2tp profile_name .....	295
[no] account profile_name .....	136
[no] activate .....	194
[no] activate .....	201
[no] activate .....	213
[no] activate .....	213
[no] activate .....	219
[no] activate .....	227
[no] activate .....	227
[no] activate .....	230
[no] activate .....	248
[no] activate .....	256
[no] activate .....	266
[no] activate .....	267
[no] activate .....	279
[no] activate .....	288
[no] activate .....	300
[no] activate .....	476
[no] activate .....	504
[no] activate .....	557
[no] activate .....	76
[no] activate .....	82



[no] activate .....	95
[no] activate .....	98
[no] additional-ddns-options .....	184
[no] address <i>address_object</i> .....	227
[no] address6 <i>address6_object</i> .....	227
[no] address6-object <i>object_name</i> { <i>ipv6_address</i>   <i>ipv6_range</i>   <i>ipv6_subnet</i> } .....	447
[no] address6-object OBJECT_NAME interface-ip interface {dhcpv6   link-local   slaac   static} { <i>addr_index</i> } .....	447
[no] address6-object <i>object_name</i> interface-subnet interface {dhcpv6   slaac   static} { <i>addr_index</i> } .....	447
[no] address-object <i>object_name</i> .....	450
[no] ad-server basedn <i>basedn</i> .....	458
[no] ad-server binddn <i>binddn</i> .....	459
[no] ad-server cn-identifier <i>uid</i> .....	459
[no] ad-server host <i>ad_server</i> .....	459
[no] ad-server password <i>password</i> .....	459
[no] ad-server password-encrypted <i>password</i> .....	459
[no] ad-server port <i>port_no</i> .....	459
[no] ad-server search-time-limit <i>time</i> .....	459
[no] ad-server ssl .....	459
[no] advertisement activate .....	268
[no] advertisement name <i>description</i> url <i>url</i> .....	268
[no] am pdu .....	76
[no] amsdu .....	76
[no] anti-botnet log [alert] .....	324
[no] anti-botnet statistics collect .....	330
[no] anti-botnet update auto .....	329
[no] anti-spam black-list [ <i>rule_number</i> ] e-mail <i>email</i> {activate deactivate} .....	396
[no] anti-spam black-list [ <i>rule_number</i> ] ip6-address <i>ipv6_subnet</i> {activate deactivate} .....	396
[no] anti-spam black-list [ <i>rule_number</i> ] ip-address <i>ip_subnet_mask</i> {activate deactivate} .....	396
[no] anti-spam black-list [ <i>rule_number</i> ] mail-header <i>mail-header mail-header-value</i> {activate deactivate} .....	396
[no] anti-spam black-list [ <i>rule_number</i> ] subject <i>subject</i> {activate deactivate} .....	396
[no] anti-spam black-list activate .....	396
[no] anti-spam dnsbl activate .....	398
[no] anti-spam ip-reputation activate .....	391
[no] anti-spam ip-reputation private-check activate .....	391
[no] anti-spam mail-content activate .....	391
[no] anti-spam mail-phishing activate .....	391
[no] anti-spam statistics collect .....	400
[no] anti-spam virus-outbreak activate .....	392
[no] anti-spam white-list [ <i>rule_number</i> ] e-mail <i>email</i> {activate deactivate} .....	396
[no] anti-spam white-list [ <i>rule_number</i> ] ip6-address <i>ipv6_subnet</i> {activate deactivate} .....	396
[no] anti-spam white-list [ <i>rule_number</i> ] ip-address <i>ip_subnet_mask</i> {activate deactivate} .....	396
[no] anti-spam white-list [ <i>rule_number</i> ] mail-header <i>mail-header mail-header-value</i> {activate deactivate} .....	396
[no] anti-spam white-list [ <i>rule_number</i> ] subject <i>subject</i> {activate deactivate} .....	396
[no] anti-spam white-list activate .....	396
[no] anti-spam xheader {white-list   black-list} <i>mail-header mail-header-value</i> ..	397
[no] anti-spam xheader dnsbl <i>mail-header mail-header-value</i> .....	399
[no] anti-spam xheader query-timeout <i>xheader-name xheader-value</i> .....	393
[no] anti-virus activate .....	310
[no] anti-virus black-list activate .....	312
[no] anti-virus cloud-query activate .....	310
[no] anti-virus cloud-query ftype-identify <i>file_type</i> .....	310
[no] anti-virus eicar activate .....	310
[no] anti-virus skip-unknown-file-type activate .....	310
[no] anti-virus statistics collect .....	316
[no] anti-virus update auto .....	315

[no] anti-virus white-list activate .....	313
[no] ap-group-profile <i>ap_group_profile_name</i> .....	68
[no] ap-mode detection activate .....	66
[no] apn <i>access_point_name</i> .....	485
[no] app <profile-name> .....	306
[no] app log_sid .....	306
[no] app statistics collect .....	306
[no] app update auto .....	306
[no] application <sid> .....	441
[no] application <i>application_object</i> .....	288
[no] application-object <object> .....	442
[no] app-profile <profile name> {[no log]   [log by-profile]} {activate   deactivate} .....	221
[no] app-watch-dog activate .....	581
[no] app-watch-dog alert .....	581
[no] app-watch-dog auto-recover .....	581
[no] app-watch-dog console-print {always once} .....	581
[no] app-watch-dog cpu-threshold min <1..100> max <1..100> .....	581
[no] app-watch-dog disk-threshold min <1..100> max <1..100> .....	581
[no] app-watch-dog interval <6..300> .....	581
[no] app-watch-dog mem-threshold min <1..100> max <1..100> .....	581
[no] app-watch-dog retry-count <1..5> .....	581
[no] app-watch-dog sys-reboot .....	582
[no] area IP [{stub   nssa}] .....	174
[no] area IP authentication .....	174
[no] area IP authentication authentication-key <i>authkey</i> .....	174
[no] area IP authentication message-digest .....	174
[no] area IP authentication message-digest-key <1..255> md5 <i>authkey</i> .....	174
[no] area IP virtual-link IP .....	174
[no] area IP virtual-link IP authentication .....	174
[no] area IP virtual-link IP authentication authentication-key <i>authkey</i> .....	174
[no] area IP virtual-link IP authentication message-digest .....	174
[no] area IP virtual-link IP authentication message-digest-key <1..255> md5 <i>authkey</i> .....	174
[no] area IP virtual-link IP authentication same-as-area .....	174
[no] area IP virtual-link IP authentication-key <i>authkey</i> .....	174
[no] area IP virtual-link IP encrypted-authentication-key < <i>ciphertext</i> > .....	174
[no] as-number <1..4294967295> .....	177
[no] as-profile <profile name> {[no log]   [log by-profile]} {activate   deactivate} .....	221
[no] authentication {chap-pap   chap   pap   mschap   mschap-v2} .....	484
[no] authentication {force   required} .....	248
[no] authentication {none   pap   chap} .....	486
[no] authentication mode {md5   text} .....	173
[no] authentication string <i>authkey</i> .....	173
[no] auth-server activate .....	476
[no] auth-server activate .....	504
[no] auth-server cert <i>certificate_name</i> .....	476
[no] auth-server cert <i>certificate_name</i> .....	504
[no] auth-server trusted-client <i>profile_name</i> .....	476
[no] auth-server trusted-client <i>profile_name</i> .....	504
[no] auto-destination .....	164
[no] auto-disable .....	164
[no] auto-healing activate .....	107
[no] av-profile <profile name>{[no log]   [log by-profile]} {activate   deactivate} .....	221
[no] backmx .....	184
[no] backup-custom <i>ip</i> .....	183
[no] backup-iface <i>interface_name</i> .....	184
[no] band {auto wcdma gsm lte} .....	138
[no] bandwidth activate .....	256
[no] bandwidth activate .....	494
[no] billing discount activate .....	255

[no] billing discount unit <2..10> price <i>price</i> .....	255
[no] billing profile <i>profile_name</i> .....	255
[no] billing replenish activate .....	255
[no] billing tax-rate activate .....	255
[no] billing wlan-ssid-profile <i>profile_name</i> .....	255
[no] bind <i>interface_name</i> .....	136
[no] block-ack .....	77
[no] broadcast .....	81
[no] broadcast .....	82
[no] budget active .....	139
[no] budget data active {download-upload   download   upload} <1..100000> .....	139
[no] budget time active <1..672> .....	139
[no] bwm activate .....	164
[no] bwm activate .....	299
[no] bwm highest sip bandwidth priority .....	300
[no] bypass {ip-reputation   mail-content   virus-outbreak} .....	391
[no] bypass {white-list   black-list   dnsbl} .....	391
[no] bypass {white-list   black-list} .....	311
[no] bypass mail-phishing .....	391
[no] bypass-firewall activate .....	207
[no] capwap activate .....	56
[no] case-sensitive .....	461
[no] case-sensitive .....	462
[no] case-sensitive .....	463
[no] cdr activate .....	405
[no] cdr block block-wireless-client .....	405
[no] cdr update auto .....	407
[no] cdr white-list ipv4 <i>ip_address</i> .....	406
[no] cdr white-list mac <i>mac_address</i> .....	406
[no] certificate <i>cert_name</i> .....	410
[no] cf-profile <profile name> {[no log]   [log by-profile]} {activate   deactivate} .....	221
[no] client-identifier <i>mac_address</i> .....	125
[no] client-name <i>host_name</i> .....	125
[no] clock auto-sync-daylight-saving .....	499
[no] clock auto-sync-timezone .....	499
[no] clock daylight-saving .....	499
[no] clock saving-interval begin {apr aug dec feb jan jul jun mar may nov oct sep} {1 2 3 4 last} {fri mon sat sun thu tue wed} <i>hh:mm</i> end {apr aug dec feb jan jul jun mar may nov oct sep} {1 2 3 4 last} {fri mon sat sun thu tue wed} <i>hh:mm</i> offset .....	499
[no] clock time-zone {- + <i>hh:mm</i> } [+ -]HH:MM. ....	499
[no] cloud-helper firmware update auto .....	534
[no] cloud-helper-notify activate .....	535
[no] cnm-agent acs password <i>tr069_acs_password</i> .....	238
[no] cnm-agent acs username <i>tr069_acs_username</i> .....	238
[no] cnm-agent activate .....	237
[no] cnm-agent authentication enable .....	238
[no] cnm-agent auto-get-accs activate .....	237
[no] cnm-agent auto-get-accs activate .....	238
[no] cnm-agent cnm-id <ID> .....	237
[no] cnm-agent encrypted-xmpp-password .....	239
[no] cnm-agent manager {https_url   http_url} .....	238
[no] cnm-agent password .....	238
[no] cnm-agent periodic-inform activate .....	238
[no] cnm-agent periodic-inform interval <10..86400> .....	238
[no] cnm-agent trigger-inform <0..8640> .....	238
[no] cnm-agent username .....	239
[no] cnm-agent vantage certificate <i>tr069_cert_file_name</i> .....	238
[no] cnm-agent xmpp-domain <i>xmpp_domain</i> .....	239

[no] cnm-agent xmpp-host <i>xmpp_host</i> .....	239
[no] cnm-agent xmpp-password <i>xmpp_password</i> .....	239
[no] cnm-agent xmpp-resource <i>xmpp_resource</i> .....	239
[no] cnm-agent xmpp-username <i>xmpp_username</i> .....	239
[no] compression {yes   no} .....	484
[no] config-backup scheduler activate .....	579
[no] configuration-payload-provide {first-dns IPv6   second-dns IPv6} .....	276
[no] configuration-payload-provide {first-dns IPv6   second-dns IPv6} .....	286
[no] configuration-payload-provide activate .....	275
[no] configuration-payload-provide activate .....	286
[no] connection-id <i>connection_id</i> .....	485
[no] connectivity {nail-up   dial-on-demand} .....	136
[no] connectivity-check continuous-log activate .....	132
[no] connectivity-check continuous-log activate .....	549
[no] console baud <i>baud_rate</i> .....	500
[no] contain <i>ap_mac</i> .....	98
[no] content-filter block message <i>message</i> .....	360
[no] content-filter block redirect <i>redirect_url</i> .....	360
[no] content-filter https-domain-filter activate .....	361
[no] content-filter https-domain-filter block-page activate .....	365
[no] content-filter profile < <i>filtering_profile</i> > safesearch .....	365
[no] content-filter profile <i>filtering_profile</i> .....	362
[no] content-filter profile <i>filtering_profile</i> category { <i>category_name</i> } .....	363
[no] content-filter profile <i>filtering_profile</i> commtouch-url category { <i>category_name</i> } .....	363
[no] content-filter profile <i>filtering_profile</i> custom .....	362
[no] content-filter profile <i>filtering_profile</i> custom activex .....	362
[no] content-filter profile <i>filtering_profile</i> custom cookie .....	362
[no] content-filter profile <i>filtering_profile</i> custom java .....	362
[no] content-filter profile <i>filtering_profile</i> custom proxy .....	363
[no] content-filter profile <i>filtering_profile</i> custom trust-allow-features .....	363
[no] content-filter profile <i>filtering_profile</i> custom trust-only .....	363
[no] content-filter profile <i>filtering_profile</i> url-server .....	362
[no] content-filter safesearch < <i>name</i> > .....	365
[no] content-filter service-timeout <i>service_timeout</i> .....	363
[no] content-filter sslv3 action block .....	362
[no] content-filter sslv3 action block .....	365
[no] content-filter statistics collect .....	366
[no] corefile copy usb-storage .....	146
[no] cpu-temperature-monitor activate .....	51
[no] crypto boost-tcp .....	271
[no] crypto ignore-df-bit .....	273
[no] crypto map <i>map_name</i> .....	273
[no] crypto map <i>map_name</i> .....	284
[no] crypto <i>map_name</i> .....	279
[no] crypto <i>map_name</i> .....	286
[no] crypto <i>profile_name</i> .....	180
[no] ctmatch {dnat   snat} .....	220
[no] ctsrts <0..2347> .....	78
[no] custom <i>ip</i> .....	183
[no] dcs activate .....	78
[no] ddns-server {FQDN DNS} .....	184
[no] deactivate .....	164
[no] deactivate .....	166
[no] default-router <i>ip</i> .....	126
[no] description < <i>description</i> > .....	441
[no] description < <i>description</i> > .....	442
[no] description <i>description</i> .....	116
[no] description <i>description</i> .....	126
[no] description <i>description</i> .....	164

[no] description <i>description</i> .....	166
[no] description <i>description</i> .....	214
[no] description <i>description</i> .....	220
[no] description <i>description</i> .....	227
[no] description <i>description</i> .....	228
[no] description <i>description</i> .....	249
[no] description <i>description</i> .....	288
[no] description <i>description</i> .....	300
[no] description DESCRIPTION .....	306
[no] description <i>description</i> .....	411
[no] description <i>description</i> .....	434
[no] description <i>description</i> .....	450
[no] description <i>description</i> .....	455
[no] description <i>description</i> .....	477
[no] description <i>description</i> .....	504
[no] destination { <i>address6_object</i>  any} .....	166
[no] destination { <i>address_object</i>   <i>group_name</i> } .....	249
[no] destination { <i>address_object</i>  any} .....	164
[no] destination <i>address_object</i> .....	300
[no] destinationip <i>address_object</i> .....	220
[no] destinationip6 <i>address_object</i> .....	220
[no] device block mac < <i>mac address</i> > .....	429
[no] device identify activate .....	429
[no] device mac < <i>mac address</i> > description < <i>description</i> > .....	429
[no] device profile < <i>profile name</i> > .....	429
[no] device profile < <i>profile name</i> > category < <i>category</i> > .....	430
[no] device profile < <i>profile name</i> > description < <i>description</i> > .....	429
[no] device profile < <i>profile name</i> > os < <i>os</i> > .....	430
[no] device-ha activate .....	419
[no] device-ha ap-mode authentication {string key   ah-md5 key} .....	420
[no] device-ha ap-mode backup sync authentication password <i>password</i> .....	421
[no] device-ha ap-mode backup sync auto .....	421
[no] device-ha ap-mode backup sync from <i>master_address</i> port <i>port</i> .....	421
[no] device-ha ap-mode backup sync interval <5..1440> .....	421
[no] device-ha ap-mode <i>interface_name</i> activate .....	420
[no] device-ha ap-mode <i>interface_name</i> manage-ip <i>ip subnet_mask</i> .....	420
[no] device-ha ap-mode master sync authentication password <i>password</i> .....	421
[no] device-ha ap-mode preempt .....	420
[no] device-ha2 activate .....	423
[no] device-ha2 connchk-monitor .....	424
[no] device-ha2 disable-session-sync .....	423
[no] device-ha2 <i>interface_name</i> activate .....	423
[no] device-ha2 manage-ip <i>ip1 ip2 subnet_mask</i> .....	423
[no] device-ha2 srv-monitor .....	424
[no] device-ha2 sync password .....	423
[no] diag-info copy usb-storage .....	146
[no] dial-string <i>isp_dial_string</i> .....	485
[no] disable-bss-color .....	77
[no] disable-dfs-switch .....	79
[no] dns-content-filter black-list activate .....	367
[no] dns-content-filter statistics collect .....	369
[no] dns-content-filter white-list activate .....	368
[no] dns-filter black-list activate .....	333
[no] dns-filter drop-malform-packet activate .....	333
[no] dns-filter drop-malform-packet log .....	333
[no] dns-filter statistics collect .....	334
[no] dns-filter white-list activate .....	334
[no] domain-name <i>domain_name</i> .....	126
[no] domainname <i>domain_name</i> .....	498

[no] domain-name <i>walled_garden_fqdn</i> .....	267
[no] dot11n-disable-coexistence .....	79
[no] downstream <0..1048576> .....	116
[no] downstream <0..1048576> .....	144
[no] downstream <0..1048576> .....	155
[no] dpd .....	271
[no] dscp {<0..63>   any   class {af11   af12   af13   af21   af22   af23   af31   af32   af33   af41   af42   af43   cs0   cs1   cs2   cs3   cs4   cs5   cs6   cs7   default   wmm_be0   wmm_be24   wmm_bk16   wmm_bk8   wmm_vi32   wmm_vi40   wmm_vo48   wmm_vo56}} .....	300
[no] dscp {any   <0..63>} .....	164
[no] dscp {any   <0..63>} .....	166
[no] dscp class {default   <i>dscp_class</i> } .....	164
[no] dscp class {default   <i>dscp_class</i> } .....	166
[no] duplex <full   half> .....	134
[no] dynamic-guest <i>user_name</i> .....	493
[no] eap type {server AAA_method user-id {name   any}   client name username {password PASSWORD   encrypted- password PASSWORD} .....	283
[no] eap type {server auth_method user-id {name   any}   client name username {password PASSWORD   encrypted- password <i>password</i> } .....	284
[no] encryption {nomppe   mppe-40   mppe-128} .....	485
[no] entry {IPv4   IPv4_CIDR   IPv4_RANGE   IPv6   IPv6_PREFIX   IPv6_RANGE   SSL_INSPECTION_WILDCARD_CNAME} 410 .....	
[no] error-url <i>url</i> .....	247
[no] fall-back .....	271
[no] <i>fall-back</i> .....	282
[no] <i>fall-back</i> .....	283
[no] fbwifi activate .....	250
[no] fbwifi idle-detection .....	250
[no] file-decompression [unsupported destroy] .....	311
[no] first-dns-server { <i>ip</i>   <i>interface_name</i> {1st-dns   2nd-dns   3rd-dns}   ZyWALL} 126	
[no] first-wins-server <i>ip</i> .....	127
[no] flood-detection {tcp-flood   udp-flood   icmp-flood   igmp-flood} {activate   log [alert]   block} 231	
[no] <i>forbid_hosts</i> .....	362
[no] force .....	249
[no] force vlan .....	68
[no] force-mu-mimo .....	79
[no] frag <256..2346> .....	79
[no] frame-capture activate .....	104
[no] free-time activate .....	263
[no] free-time auto-login .....	263
[no] free-time deliver-method onscreen .....	263
[no] free-time deliver-method sms .....	263
[no] free-time maximum-allowed-account <1..2000> .....	263
[no] free-time maximum-register-number <1..5> .....	263
[no] free-time reset-register <i>hh:mm</i> .....	263
[no] free-time time-period <i>time_period</i> .....	263
[no] from <i>zone_object</i> .....	220
[no] geo-ip database update auto .....	451
[no] google-auth .....	249
[no] groupname <i>groupname</i> .....	434
[no] groupname <i>groupname</i> .....	434
[no] gui-visibility gui-visibility policy-route-fromlocal-snat .....	586
[no] gui-visibility show-advanced .....	586
[no] ha-iface <i>interface_name</i> .....	184
[no] hardware-address <i>mac_address</i> .....	125
[no] hardware-watchdog-timer <4..37> .....	580
[no] hash-auto .....	196
[no] health-check activate .....	195
[no] hidden .....	266

[no] host <i>hostname</i> .....	183
[no] host <i>ip</i> .....	125
[no] hostname <i>hostname</i> .....	498
[no] htprotect .....	79
[no] https enable-sni .....	196
[no] icmp-decoder {bad-icmp-l4-size   icmp-fragment   icmp-smurf} activate .....	231
[no] idle <0..360> .....	485
[no] idle <0..360> .....	486
[no] idp .....	341
[no] idp anomaly white-list activate .....	233
[no] idp signature update auto .....	350
[no] idp statistics collect .....	351
[no] idp-profile <profile name> {[no log]   [log by-profile]} {activate   deactivate} .....	221
[no] igmp activate .....	156
[no] igmp direction {upstream   downstream} .....	156
[no] ignore-country-ie .....	79
[no] ikev2 policy <i>policy_name</i> .....	281
[no] ikev2 policy6 <i>policy_name</i> .....	283
[no] inbound ceiling {<0..1048576>   maximize-bandwidth-usage} .....	301
[no] inbound guarantee-bandwidth <0..1048576> priority <1..7> .....	301
[no] inbound-dscp-mark {<0..63>   class {af11   af12   af13   af21   af22   af23   af31   af32   af33   af41   af42   af43   cs0   cs1   cs2   cs3   cs4   cs5   cs6   cs7   default   wmm_be0   wmm_be24   wmm_bk16   wmm_bk8   wmm_vi32   wmm_vi40   wmm_vo48   wmm_vo56}} .....	301
[no] incoming-interface {interface <i>interface_name</i>   trunk <i>group_name</i> } .....	301
[no] in-dnat activate .....	275
[no] infected-action {destroy   send-win-msg} .....	311
[no] in-snat activate .....	275
[no] interface { <i>num/interface_name</i> } .....	160
[no] interface <i>interface_name</i> .....	116
[no] interface <i>interface_name</i> .....	138
[no] interface <i>interface_name</i> .....	165
[no] interface <i>interface_name</i> .....	166
[no] interface <i>interface_name</i> .....	180
[no] interface <i>interface_name</i> .....	201
[no] interface <i>interface_name</i> .....	213
[no] interface <i>interface_name</i> .....	264
[no] interface <i>tunnel_iface</i> .....	143
[no] interface-group <i>group-name</i> .....	159
[no] internal-welcome-url <i>url</i> .....	247
[no] ip < <i>w.x.y.z</i> > .....	251
[no] ip address dhcp .....	116
[no] ip address <i>ip subnet_mask</i> .....	116
[no] ip address <i>ip subnet_mask</i> .....	155
[no] ip address <i>ip subnet_mask</i> .....	476
[no] ip address <i>ip subnet_mask</i> .....	504
[no] ip ddns profile <i>profile_name</i> .....	183
[no] ip dhcp pool <i>profile_name</i> .....	125
[no] ip dhcp-pool <i>profile_name</i> .....	127
[no] ip dns server a-record <i>fqdn w.x.y.z</i> .....	501
[no] ip dns server mx-record <i>domain_name {w.x.y.z fqdn}</i> .....	501
[no] ip dns server zone-forwarder {<1..32> append insert <1..32>} { <i>domain_zone_name</i>  *} interface <i>interface_name</i> .....	502
[no] ip ftp server .....	519
[no] ip ftp server cert <i>certificate_name</i> .....	519
[no] ip ftp server cipher-suite {3des   des   rc4} .....	519
[no] ip ftp server port <1..65535> .....	519
[no] ip ftp server tls-required .....	519
[no] ip gateway <i>ip</i> .....	116
[no] ip helper-address <i>ip</i> .....	127

[no] ip http authentication <i>auth_method</i> .....	513
[no] ip http content-security-policy .....	513
[no] ip http port <1..65535> .....	513
[no] ip http secure-port <1..65535> .....	513
[no] ip http secure-server .....	513
[no] ip http secure-server auth-client .....	514
[no] ip http secure-server cert <i>certificate_name</i> .....	514
[no] ip http secure-server force-redirect .....	514
[no] ip http secure-server sslv3 .....	514
[no] ip http server .....	514
[no] ip http x-frame-options .....	515
[no] ip ipnp activate .....	264
[no] ip ospf {authentication-key <i>key8</i>   encrypted-authentication-key <i>encrypted_str</i> } .....	156
[no] ip ospf authentication [message-digest   same-as-area] .....	156
[no] ip ospf authentication-key <i>password</i> .....	131
[no] ip ospf cost <1..65535> .....	131
[no] ip ospf dead-interval <1..65535> .....	131
[no] ip ospf hello-interval <1..65535> .....	131
[no] ip ospf message-digest-key <1..255> {md5 <i>dr_authkey_16</i>   encrypted-md5 <i>encrypted_str</i> } ....	156
[no] ip ospf priority <0..255> .....	131
[no] ip ospf priority <i>priority</i> .....	155
[no] ip ospf retransmit-interval <1..65535> .....	131
[no] ip proxy-arp { <i>ipv4</i>   <i>ipv4_range</i>   <i>ipv4_cidr</i> } .....	123
[no] ip proxy-arp activate .....	123
[no] ip rip {send   receive} version <1..2> .....	130
[no] ip rip {send   receive} version <1..2> [1.2] .....	156
[no] ip rip v2-broadcast .....	130
[no] ip route { <i>w.x.y.z</i> } { <i>w.x.y.z</i> } { <i>interface w.x.y.z</i> } <0..127> .....	170
[no] ip route control-virtual-server-rules activate .....	170
[no] ip ssh server .....	516
[no] ip ssh server cert <i>certificate_name</i> .....	516
[no] ip ssh server port <1..65535> .....	516
[no] ip ssh server v1 .....	517
[no] ip telnet server .....	517
[no] ip telnet server port <1..65535> .....	517
[no] ip v2-broadcast .....	156
[no] ip-address < <i>w.x.y.z</i> >/<1..32> .....	267
[no] ip-address <i>ip</i> .....	214
[no] ip-decoder {ip-spoof   ip-teardrop} action {drop   reject-sender   reject-receiver   reject-both} ..	232
[no] ip-decoder {ip-spoof   ip-teardrop} activate .....	232
[no] ip-decoder {ip-spoof   ip-teardrop} log .....	232
[no] ip-reputation black-list activate .....	321
[no] ip-reputation ebl activate .....	323
[no] ip-reputation ebl update auto .....	323
[no] ip-reputation log [alert] .....	320
[no] ip-reputation log-all .....	320
[no] ip-reputation statistics collect .....	322
[no] ip-reputation update auto .....	322
[no] ip-reputation webroot incoming-category {botnets   denial-of-service   exploits   phishing   proxy   reputation   scanners   spam-sources   tor-proxy   web-attacks} ..	321
[no] ip-reputation webroot outgoing-category {botnets   phishing} .....	321
[no] ip-reputation white-list activate .....	321
[no] ip-select {iface   auto   custom} .....	183
[no] ip-select-backup {iface   auto   custom} .....	183
[no] ipv6 activate .....	509
[no] ipv6 address <i>dhcp6_profile dhcp6_suffix_128</i> .....	137
[no] ipv6 dhcp6 address-request .....	137
[no] ipv6 dhcp6 rapid-commit .....	137
[no] ipv6 dhcp6-request-object <i>dhcp6_profile</i> .....	137



[no] ipv6 enable .....	137
[no] ipv6 metric <0..15> .....	137
[no] ipv6 nd ra accept .....	137
[no] isakmp policy <i>policy_name</i> .....	271
[no] item as-report .....	558
[no] item av-report .....	558
[no] item cf-report .....	558
[no] item cpu-usage .....	558
[no] item idp-report .....	558
[no] item mem-usage .....	558
[no] item port-usage .....	558
[no] item session-usage .....	558
[no] item traffic-report .....	558
[no] join <i>interface_name</i> .....	150
[no] keyword .....	362
[no] l2tp-over-ipsec activate; .....	294
[no] l2tp-over-ipsec first-dns-server { <i>ip</i>   <i>interface_name</i> } {1st-dns 2nd-dns 3rd-dns}   { <i>ppp_in-</i> <i>terface</i> } {1st-dns 2nd-dns}} .....	294
[no] l2tp-over-ipsec first-wins-server <i>ip</i> .....	294
[no] l2tp-over-ipsec keepalive-timer <1..180> .....	294
[no] l2tp-over-ipsec second-dns-server { <i>ip</i>   <i>interface_name</i> } {1st-dns 2nd-dns 3rd-dns}   { <i>ppp_interface</i> } {1st-dns 2nd-dns}} .....	294
[no] l2tp-over-ipsec second-wins-server <i>ip</i> .....	294
[no] l2tp-over-ipsec user <i>user_name</i> .....	294
[no] language update auto .....	509
[no] lan-provision model { <i>nwa5301-nj</i>   <i>wac6502d-e</i>   <i>wac6502d-s</i>   <i>wac6503d-s</i>   .....	69
[no] lan-provision model { <i>nwa5301-nj</i>   <i>wac6502d-e</i>   <i>wac6502d-s</i>   <i>wac6503d-s</i>   .....	69
[no] lan-provision model { <i>nwa5301-nj</i>   <i>wac6502d-e</i>   <i>wac6502d-s</i>   <i>wac6503d-s</i>   .....	69
[no] lan-provision model { <i>nwa5301-nj</i>   <i>wac6502d-e</i>   <i>wac6502d-s</i>   <i>wac6503d-s</i>   .....	69
[no] ldap-server basedn .....	459
[no] ldap-server binddn <i>binddn</i> .....	459
[no] ldap-server cn-identifier <i>uid</i> .....	459
[no] ldap-server host <i>ldap_server</i> .....	459
[no] ldap-server password <i>password</i> .....	459
[no] ldap-server password-encrypted <i>password</i> .....	459
[no] ldap-server port <i>port_no</i> .....	459
[no] ldap-server search-time-limit <i>time</i> .....	459
[no] ldap-server ssl .....	459
[no] lease {<0..365> [<0..23> [<0..59>]]   infinite} .....	127
[no] limit <0..8192> .....	227
[no] limit <0..8192> .....	228
[no] listen-interface <i>interface_name</i> .....	207
[no] load-balancing [slot1   slot2] activate .....	69
[no] load-balancing [slot1   slot2] kickout .....	70
[no] load-balancing <group1   group2> <i>group_name</i> .....	57
[no] local-address < <i>ip</i> > .....	140
[no] local-address <i>ip</i> .....	136
[no] log .....	410
[no] log [alert] .....	220
[no] log [alert] .....	301
[no] log [alert] .....	311
[no] log [alert] .....	391
[no] logging cef-format include year .....	549
[no] logging console .....	553
[no] logging console category <i>module_name</i> .....	554
[no] logging debug suppression .....	551
[no] logging debug suppression interval <10..600> .....	551
[no] logging mail <1..2> .....	552
[no] logging mail <1..2> {send-log-to   send-alerts-to} <i>e_mail</i> .....	553

[no] logging mail <1..2> address {ip   hostname}	552
[no] logging mail <1..2> authentication	552
[no] logging mail <1..2> authentication username username password password	552
[no] logging mail <1..2> category module_name level {alert   all}	553
[no] logging mail <1..2> port <1..65535>	552
[no] logging mail <1..2> schedule {full   hourly}	553
[no] logging mail <1..2> subject subject	553
[no] logging mail <1..2> tls activate	552
[no] logging mail <1..2> tls starttls-off	553
[no] logging syslog <1..4>	551
[no] logging syslog <1..4> {disable   level normal   level all}	551
[no] logging syslog <1..4> address {ip   hostname}	551
[no] logging syslog <1..4> facility {local_1   local_2   local_3   local_4   local_5   local_6   local_7}	551
[no] logging syslog <1..4> format {cef   vrpt}	551
[no] logging system-log suppression	549
[no] logging system-log suppression interval <10..600>	549
[no] logging usb-storage	146
[no] logging usb-storage	549
[no] logging usb-storage keep-duration	550
[no] login-page color-background	497
[no] login-page color-window-background	497
[no] login-page message-text % message	497
[no] login-url url	247
[no] logout-ip ipv4_address	247
[no] logout-url url	248
[no] mac-auth database mac mac_address type ext-mac-address mac-role username description description	436
[no] mac-auth database mac mac_address type int-mac-address mac-role username description description	436
[no] mac-auth database mac oui type ext-oui mac-role username description description	436
[no] mac-auth database mac oui type int-oui mac-role username description description	436
[no] mail-from e_mail	558
[no] mail-from email_address	505
[no] mail-send	579
[no] mail-subject append date-time	505
[no] mail-subject append date-time	558
[no] mail-subject append system-name	505
[no] mail-subject append system-name	558
[no] mail-to-1 e_mail	558
[no] mail-to-2 e_mail	558
[no] mail-to-3 e_mail	558
[no] mail-to-4 e_mail	558
[no] mail-to-5 e_mail	558
[no] match-action pop3 {forward   forward-with-tag}	391
[no] match-action smtp {drop   forward   forward-with-tag}	391
[no] maximum-paths <1..255>	177
[no] mem-conserve activate	584
[no] mem-conserve av-bypass falling-threshold <1..4000>	584
[no] mem-conserve av-bypass rising-threshold <1..4000>	584
[no] mem-conserve av-bypass sustained-time <1..60>	584
[no] mem-conserve utm-bypass falling-threshold <1..4000>	584
[no] mem-conserve utm-bypass rising-threshold <1..4000>	585
[no] mem-conserve utm-bypass sustained-time <1..60>	585
[no] metric <0..15>	116
[no] metric <0..15>	155
[no] mode-config {first-dns   second-dns}	276
[no] mode-config {first-wins   second-wins}	277
[no] mss <536..1452>	137

[no] mss <536..1460> .....	116
[no] mtu <576..1480> .....	144
[no] mtu <576..1500> .....	116
[no] multicast .....	81
[no] multicast .....	82
[no] multicast-to-unicast .....	80
[no] mx {ip   domain_name} .....	184
[no] nail-up .....	275
[no] nail-up .....	286
[no] name description .....	266
[no] name description .....	267
[no] name profile_name .....	201
[no] narrowed .....	276
[no] narrowed .....	286
[no] nat-pmp activate .....	208
[no] natt .....	272
[no] negotiation auto .....	134
[no] neighbor ipv4 .....	177
[no] neighbor ipv4 connect-retry .....	178
[no] neighbor ipv4 default-originate .....	178
[no] neighbor ipv4 description description .....	177
[no] neighbor ipv4 ebgp-multihop hops <1..255> .....	177
[no] neighbor ipv4 maximum-prefix < 1..4294967295 > .....	178
[no] neighbor ipv4 password password .....	178
[no] neighbor ipv4 remote-as <1..4294967295> .....	177
[no] neighbor ipv4 timers < 0..65535> < 0..65535> .....	178
[no] neighbor ipv4 ttl-security [hops] <1..254> .....	178
[no] neighbor ipv4 update-source [ipv4/interface_name] .....	178
[no] neighbor ipv4 weight <1..65535> .....	177
[no] netbios-broadcast .....	275
[no] network interface area IP .....	174
[no] network interface_name .....	130
[no] network interface_name .....	173
[no] network interface_name area ip .....	131
[no] network ipv4_cidr .....	177
[no] network-extension {activate   ip- address_object   1st-dns {address_object   ip}   2nd- dns {address_object   ip}   1st-wins {address_object   ip}   2nd-wins {address_object   ip}   network address_object} .....	289
[no] network-extension netbios-broadcast .....	289
[no] network-extension traffic-enforcement .....	289
[no] network-selection {auto home} .....	139
[no] next-hop {auto gateway address_object   interface interface_name  trunk trunk_name tunnel tunnel_name} .....	165
[no] next-hop {auto gateway address_object   interface interface_name  trunk trunk_name tunnel tunnel_name} .....	166
[no] nol-channel-block .....	80
[no] ntp .....	499
[no] ntp server {fqdn w.x.y.z} .....	499
[no] object-group <object> .....	442
[no] object-group address group_name .....	449
[no] object-group group_name .....	450
[no] object-group group_name .....	455
[no] object-group service group_name .....	455
[no] outbound ceiling {<0..1048576>   maximize-bandwidth-usage} .....	301
[no] outbound guarantee-bandwidth <0..1048576> priority <1..7> .....	301
[no] outbound-dscp-mark {<0..63>   class {af11   af12   af13   af21   af22   af23   af31   af32   af33   af41   af42   af43   cs0   cs1   cs2   cs3   cs4   cs5   cs6   cs7   default   wmm_be0   wmm_be24   wmm_bk16   wmm_bk8   wmm_vi32   wmm_vi40   wmm_vo48   wmm_vo56}} .....	302
[no] outgoing-interface {interface interface_name   trunk group_name} .....	302

[no] outonly-interface <i>interface_name</i> .....	130
[no] outonly-interface <i>interface_name</i> .....	173
[no] out-snat activate .....	275
[no] override-full-power activate .....	57
[no] packet-capture activate .....	569
[no] passive-interface <i>interface_name</i> .....	130
[no] passive-interface <i>interface_name</i> .....	131
[no] passive-interface <i>interface_name</i> .....	173
[no] passive-interface <i>interface_name</i> .....	173
[no] password complexity-verify .....	434
[no] password <i>password</i> .....	484
[no] password <i>password</i> .....	485
[no] password <i>password</i> .....	506
[no] payment-service activate .....	258
[no] payment-service mobile-page-customization .....	258
[no] payment-service page-customization .....	258
[no] pin < <i>pin code</i> > .....	140
[no] ping-check activate .....	132
[no] ping-check activate .....	155
[no] policy controll-ipsec-dynamic-rules activate .....	167
[no] policy controll-virtual-server-rules activate .....	167
[no] policy override-direct-route activate .....	167
[no] policy6 override-direct-route activate .....	167
[no] policy-enforcement .....	275
[no] policy-enforcement .....	286
[no] port <1..65535> .....	201
[no] port <i>interface_name</i> .....	149
[no] printer-manager activate .....	261
[no] printer-manager encrypt activate .....	261
[no] printer-manager printer <1..10> .....	261
[no] priority-code <0.7> .....	149
[no] protocol gre .....	276
[no] pwd-expiry expiration days <1..365> .....	433
[no] pwd-expiry force-to-change-pwd activate .....	433
[no] radius-server host <i>radius_server</i> auth-port <i>auth_port</i> .....	460
[no] radius-server key <i>secret</i> .....	460
[no] radius-server timeout <i>time</i> .....	460
[no] redistribute {static   ospf} .....	173
[no] redistribute {static   rip} .....	173
[no] redistribute {static   rip} metric-type <1..2> metric <0.16777214> .....	173
[no] redistribute connected .....	177
[no] reject-legacy-station .....	80
[no] remote-address < <i>ip</i> > .....	140
[no] remote-address <i>ip</i> .....	137
[no] replay-detection .....	275
[no] replay-detection .....	286
[no] report .....	555
[no] report packet size statistics .....	557
[no] reset-counter .....	558
[no] respmsg url-filter block-page customized activate .....	508
[no] router-id IP .....	173
[no] router-id <i>router-id</i> .....	177
[no] rssi-retry .....	80
[no] rssi-thres .....	80
[no] rtls ekahau activate .....	318
[no] sandbox file-type {archives   chm   eicar   executables   macromedia-flash-data   ms-of- face-document   pdf   rtf   unknow-type} .....	336
[no] sandbox queue-packet .....	337
[no] sandbox statistics collect .....	337

[no] scan {http   ftp   imap4   smtp   pop3}	311
[no] scan {smtp   pop3}	391
[no] scan-detection {tcp-xxx} {activate   log [alert]   block}	231
[no] scan-detection {udp-portscan} {activate   log [alert]   block}	231
[no] schedule reboot activate	577
[no] schedule <i>schedule_name</i>	249
[no] schedule <i>schedule_object</i>	165
[no] schedule <i>schedule_object</i>	166
[no] schedule <i>schedule_object</i>	220
[no] schedule <i>schedule_object</i>	302
[no] second-dns-server {ip   interface_name {1st-dns   2nd-dns   3rd-dns}   ZyWALL}	126
[no] second-wins-server ip	127
[no] secret <i>secret</i>	476
[no] secret <i>secret</i>	504
[no] secure-policy activate	217
[no] secure-policy asymmetrical-route activate	217
[no] secure-policy6 activate	218
[no] secure-policy6 asymmetrical-route activate	219
[no] security-service anti-botnet-IP activate	324
[no] security-service anti-spam activate	394
[no] security-service anti-virus activate	310
[no] security-service app-patrol activate	306
[no] security-service dns-filter activate	335
[no] security-service ip-reputation activate	320
[no] security-service ips activate	340
[no] security-service sandbox activate	337
[no] server <fqdn> <w.x.y.z>	202
[no] server alternative-cn-identifier <i>uid</i>	461
[no] server alternative-cn-identifier <i>uid</i>	462
[no] server basedn <i>basedn</i>	461
[no] server basedn <i>basedn</i>	462
[no] server binddn <i>binddn</i>	461
[no] server binddn <i>binddn</i>	462
[no] server cn-identifier <i>uid</i>	461
[no] server cn-identifier <i>uid</i>	462
[no] server description <i>description</i>	461
[no] server description <i>description</i>	462
[no] server description <i>description</i>	463
[no] server group-attribute <1-255>	463
[no] server group-attribute <i>group-attribute</i>	461
[no] server group-attribute <i>group-attribute</i>	462
[no] server host <i>ad_server</i>	461
[no] server host <i>ldap_server</i>	462
[no] server host <i>radius_server</i>	463
[no] server ip	485
[no] server key <i>secret</i>	463
[no] server password <i>password</i>	461
[no] server password <i>password</i>	462
[no] server port <i>port_no</i>	461
[no] server port <i>port_no</i>	462
[no] server search-time-limit <i>time</i>	461
[no] server search-time-limit <i>time</i>	463
[no] server ssl	461
[no] server ssl	463
[no] server timeout <i>time</i>	463
[no] service {http-redirect   smtp-redirect}	202
[no] service { <i>service_name</i>  any}	165
[no] service { <i>service_name</i>  any}	166
[no] service application-group <i>app_name</i>	302

[no] service <i>service_name</i> .....	220
[no] service service-object { <i>service_name</i>   any} .....	302
[no] service-name { <i>ip</i>   <i>hostname</i>   <i>service_name</i> } .....	485
[no] service-object <i>object_name</i> .....	455
[no] service-type { <i>dyndns</i>   <i>dyndns_static</i>   <i>dyndns_custom</i>   <i>dynu-basic</i>   <i>dynu-premium</i>   <i>no-ip</i>   <i>peanut-hull</i>   <i>3322-dyn</i>   <i>3322-static</i>   <i>Selfhost</i>   <i>User custom</i> } .....	183
[no] session-limit activate .....	227
[no] session-limit6 activate .....	227
[no] session-url <i>url</i> .....	248
[no] shutdown .....	117
[no] shutdown .....	143
[no] shutdown .....	155
[no] sid {1-4294967295} .....	354
[no] signature <i>sid</i> activate .....	343
[no] slave <i>interface_name</i> .....	151
[no] <i>slot_name</i> ap-profile <i>radio_profile_name</i> .....	65
[no] <i>slot_name</i> ap-profile <i>radio_profile_name</i> .....	68
[no] <i>slot_name</i> monitor-profile <i>monitor_profile_name</i> .....	65
[no] <i>slot_name</i> monitor-profile <i>monitor_profile_name</i> Interval .....	68
[no] <i>slot_name</i> output-power <i>wlan_power</i> .....	65
[no] <i>slot_name</i> output-power <i>wlan_power</i> .....	68
[no] <i>slot_name</i> repeater-ap <i>radio_profile_name</i> .....	68
[no] <i>slot_name</i> root-ap <i>radio_profile_name</i> .....	68
[no] <i>slot_name</i> ssid-profile <1..8> <i>ssid_profile_name</i> .....	65
[no] <i>slot_name</i> ssid-profile <1..8> <i>ssid_profile_name</i> .....	68
[no] <i>slot_name</i> zymesh-profile <i>zymesh_profile_name</i> .....	65
[no] <i>slot_name</i> zymesh-profile <i>zymesh_profile_name</i> .....	68
[no] sms-service activate .....	506
[no] smtp-address { <i>ip</i>   <i>hostname</i> } .....	506
[no] smtp-auth activate .....	506
[no] smtp-auth activate .....	557
[no] smtp-auth username <i>username</i> password <i>password</i> .....	506
[no] smtp-port <1..65535> .....	506
[no] smtp-port <1..65535> .....	557
[no] smtp-tls activate .....	506
[no] smtp-tls authenticate-server .....	506
[no] smtp-tls starttls-off .....	506
[no] smtp-tls starttls-off .....	558
[no] snat { <i>outgoing-interface</i>   { <i>address_object</i> }} .....	165
[no] snmp-server .....	521
[no] snmp-server community <i>community_string</i> { <i>ro</i>   <i>rw</i> } .....	521
[no] snmp-server contact <i>description</i> .....	521
[no] snmp-server enable { <i>informs</i>   <i>traps</i> } .....	521
[no] snmp-server host { <i>w.x.y.z/fqdn/ipv6 address</i> } [ <i>community_string</i> ] .....	521
[no] snmp-server location <i>description</i> .....	521
[no] snmp-server port <1..65535> .....	521
[no] software-watchdog-timer <10..600> .....	581
[no] source { <i>address6_object</i>  any} .....	166
[no] source { <i>address_object</i>   <i>group_name</i> } .....	249
[no] source { <i>address_object</i>  any} .....	165
[no] source <i>address_object</i> .....	302
[no] source <i>profile_name</i> .....	202
[no] sourceip <i>address_object</i> .....	220
[no] sourceip6 <i>address_object</i> .....	220
[no] sourceport { <i>tcp</i>   <i>udp</i> } { <i>eq</i> <1..65535>  <i>range</i> <1..65535> <1..65535>} .....	220
[no] speed <100,10> .....	134
[no] srcport { <i>profile_name</i>  any} .....	165
[no] srcport { <i>profile_name</i>  any} .....	166
[no] ssid-profile <i>wlan_interface_index</i> <i>ssid_profile</i> .....	80

[no] ssl-inspection cert-update auto	412
[no] ssl-inspection statistics collect	413
[no] ssl-profile <profile name> { [no log]   [log by-profile] } { activate   deactivate }	221
[no] sslvpn application <i>application_object</i>	487
[no] sslvpn <i>profile_name</i>	180
[no] sslvpn <i>tunnel_name</i>	165
[no] sso	249
[no] starting-address <i>ip</i> -size <1..65535>	126
[no] suppress-retry-rts	81
[no] system default-snat	160
[no] tcp-decoder {tcp-xxx} action {drop   reject-sender   reject-receiver   reject-both}	231
[no] tcp-decoder {tcp-xxx} activate	231
[no] terms-of-service	248
[no] third-dns-server { <i>ip</i>   <i>interface_name</i> {1st-dns   2nd-dns   3rd-dns}   ZyWALL}	126
[no] threat-website action {block   log   pass   warn}	325
[no] threat-website block message <i>message</i>	325
[no] threat-website block redirect <i>url</i>	325
[no] threat-website category {anonymizers   browser-exploits   botnets   compromised   malicious-downloads   malicious-sites   malware   phishing   phishing-fraud   spam-sites   spam-urls   spyware-adware-keyloggers}	325
[no] threat-website ebl activate	327
[no] threat-website ebl update auto	328
[no] threat-website forbid-list activate	324
[no] threat-website profile < <i>profile name</i> > category { <i>anonymizers</i>   <i>malware</i>   <i>botnets</i>   <i>phishing</i> }	327
[no] threat-website profile < <i>profile name</i> > description < <i>description</i> >	326
[no] threat-website profile < <i>profile name</i> > log	327
[no] threat-website statistics collect	330
[no] threat-website trust-list activate	324
[no] to { <i>zone_object</i>  ZyWALL}	220
[no] transition-mode	89
[no] <i>trust_hosts</i>	363
[no] tunnel <i>tunnel_name</i>	165
[no] tunnel <i>tunnel_name</i>	167
[no] twofa-auth	272
[no] twofa-auth	283
[no] twofa-auth	284
[no] two-factor-auth activate	471
[no] two-factor-auth admin-access activate	473
[no] two-factor-auth admin-access deliver-method {sms email}	473
[no] two-factor-auth admin-access service {ssh telnet web}	474
[no] two-factor-auth admin-access user <i>username</i>	473
[no] two-factor-auth admin-access valid-time <1..5>	473
[no] two-factor-auth deliver-method {sms   email}	472
[no] two-factor-auth http activate	472
[no] two-factor-auth service {sslvpn ipsec l2tp}	472
[no] two-factor-auth user <i>username</i>	472
[no] two-factor-auth valid-time <1..15>	471
[no] type {domain   ip}	267
[no] type {per-user   shared   per-ip-source}	302
[no] udp-decoder {bad-udp-l4-size   udp-land   udp-smurf} activate	231
[no] ul-bandwidth-limit <1...1048576>	279
[no] upnp-igd activate	208
[no] upstream <0..1048576>	117
[no] upstream <0..1048576>	155
[no] url {URL TEXT}	184
[no] url <i>url</i>	266
[no] usb-storage activate	145
[no] usb-storage update-firmware enable	147

[no] user user_name .....	165
[no] user user_name .....	167
[no] user user_name .....	202
[no] user user_name .....	220
[no] user user_name .....	227
[no] user user_name .....	228
[no] user user_name .....	289
[no] user user_name .....	302
[no] user username .....	434
[no] user username .....	484
[no] user username .....	485
[no] username e-mail .....	506
[no] username username password password .....	183
[no] users idle-detection .....	435
[no] users idle-detection timeout <1..60> .....	435
[no] users lockout-period <1..65535> .....	435
[no] users retry-count <1..99> .....	435
[no] users retry-limit .....	435
[no] users simultaneous-logon {administration   access} enforce .....	435
[no] users simultaneous-logon {administration   access} limit <1..1024> .....	435
[no] users update-lease automation .....	435
[no] version <1..2> .....	173
[no] vlan-id <1..4094> .....	149
[no] vlan_interface .....	58
[no] vpn-concentrator profile_name .....	279
[no] vpn-concentrator6 profile_name .....	286
[no] vpn-configuration-provision activate .....	279
[no] vpn-configuration-provision iosfilter .....	280
[no] walled-garden activate .....	265
[no] walled-garden rule <1..50> .....	265
[no] wan-iface interface_name .....	184
[no] web-auth activate .....	245
[no] web-auth redirect-fqdn host_str .....	245
[no] webpage-encrypt .....	488
[no] welcome-url url .....	248
[no] wildcard .....	184
[no] wireless-health {activate   radio   sta} .....	100
[no] wlan-macfilter-profile macfilter_profile_name .....	92
[no] wlan-monitor-profile monitor_profile_name .....	82
[no] wlan-radio-profile radio profile name .....	100
[no] wlan-radio-profile radio_profile_name .....	75
[no] wlan-security-profile security_profile_name .....	87
[no] wlan-ssid-profile ssid_profile_name .....	85
[no] zero-wait-dfs .....	81
[no] zone profile_name .....	180
[no] zymesh-profile zymesh_profile_name .....	94
[no] address6-object object_name interface-gateway interface {slaac   static} {addr_index} .....	447
[no] https activate .....	183
[no] igmp activate .....	122
{anomaly   signature   system-protect} activate .....	341
{anomaly   signature   system-protect} activation .....	341
{bg   bgn   a   ac   an   bgnax   anacax} .....	77
<1..32>   insert <1..32>} .....	230
<1..32>   move <1..32> to <1..32>} .....	230
<1..4094> .....	406
<profile1> <profile2> .....	229
/ browser-exploits / phishing-fraud / compromised / spam-sites / malicious-downloads / spam-urls / malicious-sites / spyware-adware-keyloggers} .....	327
uint32 <0..4294967295>   ip ipv4 [ipv4]   fqdn fqdn [fqdn [fqdn]]   text text   hex hex   vivc enter-	



<code>prise_id hex_s [enterprise_id hex_s]   vivs enterprise_id hex_s [enterprise_id hex_s]</code>	126
<code>2g-basic-speed speed</code>	75
<code>2g-channel wireless_channel_2g</code>	75
<code>2g-multicast-speed wlan_2g_support_speed</code>	75
<code>2g-wlan-rate-control rate_2g</code>	75
<code>5g-basic-speed speed</code>	75
<code>5g-channel wireless_channel_5g</code>	75
<code>5g-multicast-speed wlan_5g_basic_speed</code>	75
<code>5g-wlan-rate-control rate_5g</code>	76
<code>aaa authentication [no] match-default-group</code>	466
<code>aaa authentication default member1 [member2] [member3] [member4]</code>	465
<code>aaa authentication profile-name member1 [member2] [member3] [member4]</code>	466
<code>aaa authentication rename profile-name-old profile-name-new</code>	465
<code>aaa group server ad group-name</code>	461
<code>aaa group server ad rename group-name group-name</code>	460
<code>aaa group server ldap group-name</code>	462
<code>aaa group server ldap rename group-name group-name</code>	462
<code>aaa group server radius group-name</code>	463
<code>aaa group server radius rename {group-name-old} group-name-new</code>	463
<code>access-page message-color {color-rgb   color-name   color-number}</code>	497
<code>access-page title title</code>	497
<code>access-page window-color {color-rgb   color-name   color-number}</code>	497
<code>account profile_name</code>	138
<code>account profile_name</code>	295
<code>action {allow deny reject}</code>	219
<code>activate</code>	233
<code>activate</code>	262
<code>activate</code>	271
<code>activate</code>	273
<code>activate</code>	281
<code>activate</code>	283
<code>activate</code>	285
<code>address ipv6_addr_prefix</code>	117
<code>address ipv6_addr_prefix</code>	119
<code>address6-object object_name {ip   ip_range   ip_subnet   fqdn fqdn  geography country code   interface-ip   interface-subnet   interface-gateway} {interface_name   virtual interface name}</code>	446
<code>address6-object object_name geography &lt;country code&gt; all</code>	446
<code>address-object object_name {ip   ip_range   ip_subnet   fqdn fqdn  geography country code   interface-ip   interface-subnet   interface-gateway} {interface_name   virtual interface name}</code>	446
<code>address-object object_name geography &lt;country code&gt; all</code>	446
<code>address-object rename object_name object_name</code>	446
<code>adjust-mss {auto   &lt;200..1500&gt;}</code>	274
<code>adjust-mss {auto   &lt;200..1500&gt;}</code>	285
<code>advertisement flush</code>	268
<code>advertisement rename description_old description_new</code>	268
<code>algorithm {wrr llf spill-over}</code>	159
<code>anti-botnet action {forward   reject-both   reject-receiver   reject-sender}</code>	324
<code>anti-botnet statistics flush</code>	330
<code>anti-botnet update daily &lt;0..23&gt;</code>	329
<code>anti-botnet update hourly</code>	329
<code>anti-botnet update signatures</code>	329
<code>anti-botnet update weekly {sun   mon   tue   wed   thu   fri   sat} &lt;0..23&gt;</code>	329
<code>anti-spam dnsbl [1..5] domain dnsbl_domain {activate deactivate}</code>	398
<code>anti-spam dnsbl ip-check-order {forward   backward}</code>	398
<code>anti-spam dnsbl max-query-ip [1..5]</code>	398
<code>anti-spam dnsbl query-timeout pop3 {forward   forward-with-tag}</code>	398
<code>anti-spam dnsbl query-timeout smtp {drop   forward   forward-with-tag}</code>	398

anti-spam dnsbl query-timeout time [1..10]	399
anti-spam dnsbl statistics flush	399
anti-spam ip-reputation query-timeout time [timeout]	391
anti-spam ip-reputation statistics flush	391
anti-spam mail-phishing query-timeout pop3 {forward   forward-with-tag}	392
anti-spam mail-phishing query-timeout smtp {drop   forward   forward-with-tag}	392
anti-spam mail-phishing query-timeout time [timeout]	392
anti-spam mail-scan query-timeout pop3 {forward   forward-with-tag}	392
anti-spam mail-scan query-timeout smtp {drop   forward   forward-with-tag}	392
anti-spam mail-scan query-timeout time [timeout]	392
anti-spam profile append	390
anti-spam profile delete rule_number	391
anti-spam profile insert rule_number	390
anti-spam profile move rule_number to rule_number	391
anti-spam profile rule_number	390
anti-spam statistics flush	400
anti-spam tag {dnsbl   dnsbl-timeout} [tag]	398
anti-spam tag {mail-content   mail-phishing   virus-outbreak} [tag]	392
anti-spam tag black-list [tag]	396
anti-spam tag mail-phishing [tag]	392
anti-spam tag query-timeout [tag]	392
anti-spam xheader {mail-content   virus-outbreak} xheader-name xheader-value	392
anti-spam xheader mail-phishing xheader-name xheader-value	392
anti-virus black-list {md5-hash md5-pattern   file-pattern file-pattern} {activate deactivate}	312
anti-virus black-list {replace <1..256>  file-pattern file-pattern md5-hash md5-pattern	313
anti-virus mail-infect-ext activate	310
anti-virus profile_name	311
anti-virus reload signatures	310
anti-virus rename old_profile_name new_profile_name	311
anti-virus scan mode {express   hybrid   stream}	310
anti-virus statistics flush	316
anti-virus update ctdb	315
anti-virus update daily <0..23>	315
anti-virus update hourly	315
anti-virus update signatures	315
anti-virus update weekly {sun   mon   tue   wed   thu   fri   sat} <0..23>	315
anti-virus white-list {md5-hash md5-pattern   file-pattern file-pattern} {activate deactivate}	313
anti-virus white-list {replace <1..256>  file-pattern file-pattern md5-hash md5-pattern	313
ap internal-auth no shared-secret	59
ap-group first-priority ap_group_profile_name	67
ap-group flush wtp-setting ap_group_profile_name	67
ap-group-member ap_group_profile_name [no] member mac_address	68
ap-group-member ap_group_wlan_name[no] member local-ap	68
ap-group-profile ap_group_profile_name	65
ap-group-profile rename ap_group_profile_name1 ap_group_profile_name2	71
ap_mac	95
ap_mac	98
app reload signatures	306
app rename <profile-name> <profile-name>	306
app statistics flush	306
app update	306
app update daily<0..23>	306
app update hourly	306
app update weekly {sun   mon   tue   wed   thu   fri   sat} <0..23>	306
application <profile-name> action {forward drop reject} {no log log [alert]}	306
application-object <object>	441
application-object rename <object> <object>	441

apply	41
apply /conf/file_name.conf [ignore-error] [rollback]	528
app-watch-dog reboot-log flush	582
area IP virtual-link IP message-digest-key <1..255> encrypted-authentication-key	175
area IP virtual-link IP message-digest-key <1..255> md5 authkey	175
arp {arp-interval <1..1000>   arp-ip-target <W.X.Y.Z>}	152
arp IP mac_address	573
atse	41
authentication {chap   chap-pap   mschap   mschap-v2   pap}	295
authentication {pre-share   rsa-sig   user-base-psk }	271
authentication {pre-share   rsa-sig}	282
authentication {pre-share   rsa-sig}	283
authentication key <1..255> key-string authkey	173
authentication-type {<profile name>   default-user-agreement   default-web-portal   facebook-wifi}	248
auth_method	476
auth_method	504
auth-server authentication	476
auth-server authentication	504
auto-healing activate: yes	108
auto-healing healing threshold: -85 dBm	108
auto-healing healing-interval interval	107
auto-healing healing-threshold	107
auto-healing interval: 10	108
auto-healing margin	108
auto-healing margin: 0	108
auto-healing power threshold: -70 dBm	108
auto-healing power-threshold <-50~-80>	108
auto-healing update	108
band {2.4G   5G} band-mode	77
bandwidth {upload   download} <0..1048576> priority <1..7>	256
bandwidth {upload   download} <0..1048576> priority <1..7>	494
base {all   everything   none}	230
beacon-interval <40..1000>	77
billing accounting-method {accumulation   time-to-finish }	254
billing accumulation idle-detection timeout <1..60>	254
billing accumulation-expire {day <1..360>   hour <1..24>}	254
billing currency {eur   gbp   usd   user-define currency_code }	254
billing decimal-places <2>	254
billing decimal-symbol {comma   dot}	254
billing discount button {a   b   c} [charge-by-level]	255
billing profile rename profile_name profile_name	255
billing tax-rate <0..100>	255
billing unused-expire {minute <30..60>   hour <1..24>   day <1..365>}	255
billing username-password-length <4..6>	255
bind profile	230
binding interface interface_name crypto-map map_name	156
bind-ipv4-addr ipv4	410
bind-ipv6-addr ipv6	410
broadcast pps <1~10000>	81
broadcast pps <1~10000>	82
bss-color <0-63>	77
budget {log   log-alert}[recursive <1..65535>]	139
budget {log-percentage   log-percentage-alert} [recursive <1..65535>]	140
budget current-connection {keep   drop}	140
budget new-connection {allow   disallow}	139
budget percentage {ptime   pdata} <0..99>	140
budget reset-counters	139
budget reset-day <0..31>	139
bwm <1..127>	299

bwm <1..127>	300
bwm append	299
bwm default inbound priority <1..7>	299
bwm default outbound priority <1..7>	299
bwm delete <1..127>	299
bwm insert <1..127>	300
bwm modify <1..127>	300
bwm move <1..127> to <1..127>	300
ca generate pkcs10 name <i>certificate_name</i> cn-type {ip cn <i>cn_ipv4_address</i>   ipv6 cn <i>cn_ipv6_address</i>   fqdn cn <i>cn_domain_name</i>   mail cn <i>cn_email</i> } [ou <i>organizational_unit</i> ] [o <i>organization</i> ] [l <i>town</i> ] [s <i>state</i> ] [c <i>country</i> ] [usr-def <i>user_definition</i> ] key-type {dsa   dsa-sha256   ecdsa   ecdsa-sha256   ecdsa-sha384   rsa   rsa-sha256   rsa-sha512} key-len <i>key_length</i> [extend-key <i>extend_key</i> ] year <i>lifetimes</i>	480
ca generate pkcs12 name <i>name</i> password <i>password</i>	480
ca generate x509 name <i>certificate_name</i> cn-type {ip cn <i>ipv4</i>   ipv6 cn <i>cn_ipv6_address</i>   fqdn cn <i>cn_domain_name</i>   mail cn <i>cn_email</i> } [ou <i>organizational_unit</i> ] [o <i>organization</i> ] [l <i>town</i> ] [s <i>state</i> ] [c <i>country</i> ] [usr-def <i>user_definition</i> ] key-type {dsa   dsa-sha256   ecdsa   ecdsa-sha256   ecdsa-sha384   rsa   rsa-sha256   rsa-sha512} key-len <i>key_length</i>	480
ca rename category {local remote} <i>old_name</i> <i>new_name</i>	481
ca validation <i>remote_certificate</i>	481
capwap ap ac-ip { <i>primary_ac_ip</i> } { <i>secondary_ac_ip</i> }	57
capwap ap ac-ip { <i>primary_ac_ip/primary_ac_dns</i> } { <i>secondary_ac_ip/secondary_ac_dns</i> }	588
capwap ap ac-ip auto	57
capwap ap ac-ip auto	588
capwap ap add <i>ap_mac</i> [ <i>ap_model</i> ]	57
capwap ap <i>ap_mac</i>	56
capwap ap <i>ap_mac</i>	64
capwap ap factory default <i>ap_mac</i>	57
capwap ap fallback disable	57
capwap ap fallback enable	58
capwap ap fallback interval <30..86400>	58
capwap ap idle timeout {25-100}	58
capwap ap kick {all   <i>ap_mac</i> }	58
capwap ap led-off <i>ap_mac</i>	58
capwap ap led-on <i>ap_mac</i>	58
capwap ap local-ap	65
capwap ap reboot <i>ap_mac</i>	58
capwap ap vlan ip address <i>ip</i> <i>netmask</i>	588
capwap ap vlan ip gateway <i>gateway</i>	588
capwap ap vlan no ip gateway	588
capwap ap vlan vlan-id <i>vid</i> { tag   untag }	588
capwap manual-add {enable   disable}	58
capwap station kick <i>sta_mac</i>	58
cdp {activate deactivate}	481
cdr block http-service-port <1..65535>	405
cdr block https-service-port <1..65535>	405
cdr block message <i>denied_message</i>	405
cdr block period <0..1440>	405
cdr block redirect < <i>url</i> >	405
cdr block url { <i>message/redirect</i> }	405
cdr blocked-by { <i>ip/mac</i> }	405
cdr quarantine period <0..1440>	406
cdr quarantine vlan-id	406
cdr rule <i>rule_id</i> threshold <i>occurrence</i> duration <i>duration</i> action {alert block quarantine}	406
cdr send-alerts-to <i>email_address</i>	406
cdr signature reload	407
cdr signature update	407
cdr unblock ipv4 <i>ip_address</i>	406
cdr unblock mac <i>mac_address</i>	406

cdr update daily <0..23>	407
cdr update hourly	407
cdr update weekly {sun   mon   tue   wed   thu   fri   sat} <0..23>	407
cdr white-list replace <1..512> ipv4 ip_address	406
cdr white-list replace <1..512> mac mac_address	406
certificate certificate-name	271
certificate certificate-name	282
certificate certificate-name	283
certificate cert_name	294
charge price	494
check-period 1-86400	196
ch-width wlan_htcw	77
clear	41
clear aaa authentication profile-name	465
clear aaa group server ad [group-name]	460
clear aaa group server ldap [group-name]	462
clear aaa group server radius group-name	463
clear ip dhcp binding {ip   *}	127
clear logging debug buffer	551
clear logging system-log buffer	549
clear report [interface_name]	555
clock date yyyy-mm-dd time hh:mm:ss	499
clock time hh:mm:ss	499
cloud-helper check all	533
cloud-helper check app	533
cloud-helper check app_incr	533
cloud-helper check av	534
cloud-helper check botnet	534
cloud-helper check ctdb	534
cloud-helper check firmware	534
cloud-helper check geoip	534
cloud-helper check idp	534
cloud-helper check rf	534
cloud-helper check sslca	534
cloud-helper check-notify new_features_rap	534
cloud-helper check-notify new_features_cdr	534
cloud-helper check-notify new_features_dns_cf	534
cloud-helper check-notify now	534
cloud-helper check-notify service_expired	534
cloud-helper check-notify whats_new	534
cloud-helper clean-download firmware	534
cloud-helper firmware update daily <0..23> reboot {no   yes}	534
cloud-helper firmware update weekly {fri   mon   sat   sun   thu   tue   wed} <0..23> reboot {no   yes}	534
cloud-helper get app	534
cloud-helper get av	535
cloud-helper get botnet	535
cloud-helper get firmware <1..2>	535
cloud-helper get idp	535
cloud-helper get sslca	535
cloud-helper pause-download firmware <1..2>	535
cloud-helper set {[retry_times <1..10>]} {[retry_period <2..60>]} {[retry_fail_period <180..720>]}	535
cloud-helper set remind {every-time   never}	535
cloud-helper set-read new_features_cdr	535
cloud-helper set-read new_features_dns_cf	535
cloud-helper set-read service_expired	535
cloud-helper set-read whats_new	535
cloud-helper update firmware <1..2>	535

cnm-agent server-type [vantage   tr069] .....	238
Command .....	194
config-backup run .....	579
config-backup setting .....	579
configuration-payload-provide address- {} .....	275
configuration-payload-provide address- {} .....	286
configure .....	41
conf-mail {mail-to-1/mail-to-2/mail-to-3/mail-to-4/mail-to-5} <user@domainname> ..	578
conf-mail attach password <attachment password> .....	578
conf-mail mail-content <mail-content> .....	578
conf-mail mail-subject <subject> .....	578
conf-mail no {mail-to-1/mail-to-2/mail-to-3/mail-to-4/mail-to-5} .....	578
conf-mail no mail-content .....	578
conf-mail send-now <configfile> .....	579
conn-check {FQDN   addr   activate} .....	164
conn-check {ip address ip address / first-and-last} method {icmp   tcp} period <5...3600> timeout <1...10> fail- tolerance <1...10> action {log   no-log} probe-condition {all   any} .....	277
connectivity {nail-up   dial-on-demand} .....	140
connect-timeout 1-300 .....	196
content-filter cf-queue flush .....	361
content-filter common-list {trust forbid} .....	361
content-filter dashboard statistics flush .....	50
content-filter https-domain-filter block-cache-ttl <1~60> .....	365
content-filter https-domain-filter block-page port <port> .....	365
content-filter https-domain-filter forward-cache-ttl <1~1440> .....	365
content-filter passed warning flush .....	360
content-filter passed warning timeout <1..1440> .....	360
content-filter profile <i>filtering_profile</i> [commtouch-url] log-all .....	364
content-filter profile <i>filtering_profile</i> [commtouch-url] match {block   log   pass} ..	363
content-filter profile <i>filtering_profile</i> [commtouch-url] offline {block   log   warn   pass} 364	
content-filter profile <i>filtering_profile</i> [commtouch-url] unrate {block   log   warn   pass} 364	
content-filter profile <i>filtering_profile</i> commtouch-url log-all .....	364
content-filter profile <i>filtering_profile</i> commtouch-url match {block   log   pass} ..	363
content-filter profile <i>filtering_profile</i> commtouch-url match-unsafe {block   log   warn  pass} 363	
content-filter profile <i>filtering_profile</i> commtouch-url offline {block   log   warn   pass} 364	
content-filter profile <i>filtering_profile</i> commtouch-url unrate {block   log   warn   pass} ..	364
content-filter profile <i>filtering_profile</i> custom-list forbid .....	362
content-filter profile <i>filtering_profile</i> custom-list keyword .....	362
content-filter profile <i>filtering_profile</i> custom-list trust .....	363
content-filter report deactivate .....	357
content-filter report server {ip_address   hostname} .....	357
content-filter statistics flush .....	366
content-filter url-cache clear .....	360
content-filter url-cache clear url .....	360
content-filter url-server test .....	361
content-filter url-server test commtouch .....	360
cookie match <string> .....	366
cookie parameter <string> .....	366
cookie value <string> .....	366
copy .....	41
copy {/conf   /idp   /packet_trace   /script   /tmp}file_name-a.conf {/conf   /idp   /pack- et_trace   /script   /tmp}/file_name-b.conf .....	528
copy running-config /conf/file_name.conf .....	529
copy running-config startup-config .....	529
country-code country_code .....	58

country-code <i>country_code</i> .....	77
country-code <i>country_code</i> .....	82
cpu-temperature-monitor period <i>minutes</i> .....	51
cpu-temperature-monitor unit {celsius  fahrenheit} .....	51
create-time <i>yyyy-mm-dd hh:mm</i> .....	494
crypto map dial <i>map_name</i> .....	273
crypto map <i>map_name</i> .....	278
crypto map <i>map_name</i> .....	284
crypto map rename <i>map_name map_name</i> .....	273
crypto map rename <i>map_name map_name</i> .....	284
crypto map6 dial <i>map_name</i> .....	284
crypto <i>map_name</i> .....	279
currency {eur   gbp   usd   user-define <i>currency_code</i> } .....	494
daily-report .....	557
dcs 2g-selected-channel <i>2.4g_channels</i> .....	78
dcs 5g-selected-channel <i>5g_channels</i> .....	78
dcs channel-deployment {3-channel  4-channel} .....	78
dcs client-aware {enable  disable} .....	78
dcs dcs-2g-method {auto  manual} .....	78
dcs dcs-5g-method {auto  manual} .....	78
dcs dfs-aware {enable  disable} .....	78
dcs mode {interval  schedule} .....	78
dcs now { <i>ap_mac</i>   <i>profile_name</i> } .....	106
dcs schedule <hh:mm> {mon  tue  wed  thu  fri  sat  sun} .....	78
dcs sensitivity-level {high  medium   low} .....	79
dcs time-interval <i>interval</i> .....	79
deactivate .....	233
deactivate .....	262
deactivate .....	271
deactivate .....	273
<i>deactivate</i> .....	281
<i>deactivate</i> .....	283
deactivate .....	285
debug (*) .....	41
delete .....	41
delete {/conf   /idp   /packet_trace   /script   /tmp}/ <i>file_name</i> .....	529
description <i>description</i> .....	230
description <i>description</i> .....	262
description <i>description</i> .....	68
description <i>description</i> .....	79
description <i>description2</i> .....	343
description <i>profile_description</i> .....	311
<i>description2</i> .....	95
details .....	41
device profile rename <profile name> <profile name> .....	429
device-ha ap-mode backup sync now .....	421
device-ha ap-mode cluster-id <1..32> .....	420
device-ha ap-mode priority <1..254> .....	420
device-ha ap-mode role {master backup} .....	420
device-ha mode active-passive .....	419
device-ha2 ap-firmware-sync .....	424
device-ha2 failover connchk-hold-time <60..86400> .....	424
device-ha2 failover reset-interval <1..30> .....	424
device-ha2 failover-count <5 ..50> .....	424
device-ha2 firmware-update check-timeout .....	424
device-ha2 firmware-update delay .....	424
device-ha2 heartbeat period <1..10> fail-tolerance <1..10> .....	424
device-ha2 license-sync <i>serial_number</i> .....	424
device-ha2 schedule-reboot check-timeout <1..3600> .....	578

device-ha2 schedule-reboot delay <1..300> .....	578
device-ha2 sync password <i>password</i> .....	423
device-ha2 sync_from_active .....	423
device-ha2 sync_to_passive .....	423
device-ha2 virtual-mac <i>zynos_style_mac_address</i> .....	424
dhcp6 .....	119
dhcp6 { server   client   relay upper { <i>config_interface</i>   <i>ipv6_addr</i> } } .....	118
dhcp6 address-request .....	118
dhcp6 address-request .....	119
dhcp6 duid { <i>duid</i>   <i>mac</i> } .....	118
dhcp6 rapid-commit .....	118
dhcp6 rapid-commit .....	119
dhcp6 refresh-time { <600..4294967294>   infinity } .....	118
dhcp6-lease-object <i>dhcp6_profile</i> .....	118
dhcp6-lease-object <i>dhcp6_profile</i> .....	119
dhcp6-lease-object <i>dhcp6_profile</i> { sip-server   ntp-server   dns-server } { <i>ipv6_addr</i>   <i>dhcp6_</i> <i>profile</i> } .....	491
dhcp6-lease-object <i>dhcp6_profile</i> address <i>ipv6_addr</i> <i>duid</i> <i>duid</i> .....	490
dhcp6-lease-object <i>dhcp6_profile</i> address- <i>ipv6_addr</i> <i>ipv6_addr</i> .....	491
dhcp6-lease-object <i>dhcp6_profile</i> prefix-delegation <i>ipv6_addr_prefix</i> <i>duid</i> <i>duid</i> ...	491
dhcp6-lease-object rename <i>dhcp6_profile</i> <i>dhcp6_profile</i> .....	491
dhcp6-request-object <i>dhcp6_profile</i> .....	118
dhcp6-request-object <i>dhcp6_profile</i> .....	120
dhcp6-request-object <i>dhcp6_profile</i> { dns-server   ntp-server   prefix-delegation   sip-server } 491	
dhcp6-request-object rename <i>dhcp6_profile</i> <i>dhcp6_profile</i> .....	491
dhcp-option <1..254> <i>option_name</i> {boolean <0..1>   uint8 <0..255>   uint16 <0..65535> } .....	126
diag .....	42
diag-info .....	42
diag-info collect .....	561
diaginfo collect ac .....	561
diaginfo collect wtp .....	561
diaginfo delete /ac .....	561
diaginfo delete /wtp .....	561
dir .....	42
dir {/conf   /idp   /packet_trace   /script   /tmp} .....	529
disable .....	42
dns query <i>fqdn</i> .....	196
dns-content-filter black-list FQDN {activate   deactivate} .....	367
dns-content-filter black-list replace <1..256> FQDN {activate   deactivate} .....	368
dns-content-filter fake-dns-response-ttl <300...86400> .....	368
dns-content-filter profile <i>profilename</i> .....	369
dns-content-filter redirect-ip custom IPv4 .....	368
dns-content-filter redirect-ip default .....	368
dns-content-filter statistics flush .....	369
dns-content-filter white-list FQDN {activate   deactivate} .....	368
dns-content-filter white-list replace <1..256> FQDN {activate   deactivate} .....	368
dns-filter black-list FQDN {activate deactivate} .....	333
dns-filter black-list replace <1..256> FQDN {activate deactivate} .....	333
dns-filter fake-dns-response-ttl <300...86400> .....	335
dns-filter profile <i>profilename</i> .....	333
dns-filter redirect-ip custom IPv4 .....	334
dns-filter redirect-ip default .....	334
dns-filter rename <i>old_profile_name</i> <i>new_profile_name</i> .....	334
dns-filter statistics flush .....	334
dns-filter white-list FQDN {activate deactivate} .....	334
dns-filter white-list replace <1..256> FQDN {activate deactivate} .....	334
domain match < <i>string</i> > .....	365
domain not-match < <i>string</i> > .....	365



dot11-preamble {long   short} .....	79
downdelay <0..1000> .....	152
dpd-interval <15..60> .....	271
draw-usage-graphics .....	557
dscp-marking <0..63> .....	164
dscp-marking <0..63> .....	166
dscp-marking class {default   <i>dscp_class</i> } .....	164
dscp-marking class {default   <i>dscp_class</i> } .....	166
dtim-period <1..255> .....	79
duration <0..300> .....	569
dynamic-guest freeuser <i>user_name</i> .....	493
dynamic-guest generate .....	493
dynamic-guest generate-freeuser .....	493
dynamic-guest keep-user-logged-in .....	493
eap auth_method AUTH_METHOD .....	282
eap auth_method <i>auth_method</i> .....	284
e-mail <i>email_address</i> .....	494
enable .....	117
enable .....	119
enable .....	42
encapsulation {tunnel   transport} .....	274
encapsulation {tunnel   transport} .....	285
encrypted-password <i>ciphertext</i> .....	295
encrypted-password <i>ciphertext</i> .....	484
encrypted-password <i>password</i> .....	494
encrypted-string ciphertext .....	173
exit .....	104
exit .....	116
exit .....	134
exit .....	144
exit .....	159
exit .....	165
exit .....	166
exit .....	177
exit .....	201
exit .....	227
exit .....	228
exit .....	232
exit .....	247
exit .....	279
exit .....	311
exit .....	326
exit .....	354
exit .....	361
exit .....	361
exit .....	362
exit .....	362
exit .....	363
exit .....	410
exit .....	410
exit .....	411
exit .....	42
exit .....	558
exit .....	579
exit .....	66
exit .....	68
exit .....	81
exit .....	82
exit .....	82

exit .....	83
exit .....	86
exit .....	90
exit .....	92
exit .....	94
exit .....	96
exit .....	98
expire-time <i>yyyy-mm-dd hh:mm</i> .....	494
FACILITY .....	552
fall-back-check-interval <60..86400> .....	272
fall-back-check-interval <60..86400> .....	282
fall-back-check-interval <60..86400> .....	283
fast forwarding { <i>activate</i>   <i>deactivate</i> } .....	511
fbwifi idle-detection timeout <1..60> .....	250
fbwifi reset-fbpage .....	250
fbwifi security { <i>high</i>   <i>low</i> } .....	250
<i>file_name</i> .....	103
file-prefix <i>file_name</i> .....	104
files-size <1..10000> .....	570
files-size <i>mon_dir_size</i> .....	104
file-suffix < <i>profile_name</i> > .....	570
firewall icsa { <i>icmp-destroy-session</i> } { <i>enable</i>   <i>disable</i> } .....	217
flood-detection block-period <1..3600> .....	231
flush .....	159
follow-real-client-routing { <i>yes</i>   <i>no</i> } .....	411
fqdn-object query-period <1..1440> .....	447
fqdn-object sync-period <1..5> .....	447
fqdn-object test <i>fqdn</i> .....	447
frame-capture configure .....	104
friendly-ap <i>ap_mac description2</i> .....	96
from-zone <i>zone_rule</i> .....	230
gateway .....	119
gateway <i>ipv6_addr</i> metric <0..15> .....	117
geo-ip database update <i>country</i> .....	451
geo-ip database update weekly { <i>fri</i>   <i>mon</i>   <i>sat</i>   <i>sun</i>   <i>thu</i>   <i>tue</i>   <i>wed</i> } <0..23> ..	451
group1 .....	272
group1 .....	282
group1 .....	283
group14 .....	272
group14 .....	282
group15 .....	282
group16 .....	282
group17 .....	282
group18 .....	282
group2 .....	272
group2 .....	282
group2 .....	283
group5 .....	272
group5 .....	282
group5 .....	283
groupname rename <i>groupname groupname</i> .....	434
guard-interval <i>wlan_htgi</i> .....	79
health-check type { <i>http</i>   <i>https</i>   <i>tcp</i>   <i>smtp</i>   <i>dns</i>   <i>ping</i> } .....	196
host <i>sni</i> .....	196
host-ip { <i>ip-address</i>   <i>profile_name</i>   <i>any</i> > .....	570
HOSTNAME .....	552
host-port <0..65535> .....	570
http path <i>url</i> .....	196
icmp-decoder { <i>bad-icmp-l4-size</i>   <i>icmp-fragment</i>   <i>icmp-smurf</i> } action { <i>drop</i>   <i>reject-sender</i>   <i>reject-receiver</i>   <i>re-</i>	

ject-both} .....	232
icmp-decoder {bad-icmp-l4-size   icmp-fragment   icmp-smurf} log [alert] .....	232
idle <0..360> .....	295
idp anomaly rule {delete .....	230
idp anomaly adp-profile [base {all   everything   none}] .....	230
idp anomaly rule {append   .....	230
idp anomaly white-list rename rule-name new-rule-name .....	234
idp anomaly white-list rule-name .....	233
idp customize signature edit quoted_string .....	347
idp customize signature quoted_string .....	347
idp customize_import name sig_name .....	347
idp packet-capture {enable   disable} .....	354
idp packet-capture default setting .....	354
idp packet-capture select {add-id sid   del-id sid} .....	354
idp packet-capture select {enable   disable} .....	354
idp packet-capture show status .....	354
idp reload .....	341
idp rename anomaly .....	229
idp rename signature profile1 profile2 .....	342
idp search signature my_profile name quoted_string sid SID severity severity_mask platform plat- form_mask classtype classtype_mask service service_mask activate {any   yes   no} log {any   no   log   log-alert} action action_mask .....	345
idp session-block {activate   deactivate} .....	341
idp session-block period {1-3600} .....	341
idp signature default_profile .....	344
idp signature mode {detection   prevention} .....	342
idp signature newpro [base {all   lan   wan   dmz   none}] .....	343
idp signature profile signature sid {activate   log [alert]   action {drop   reject-sender   reject-receiver   reject-both}} .....	342
idp signature update daily <0..23> .....	350
idp signature update hourly .....	350
idp signature update signatures .....	350
idp signature update weekly {sun   mon   tue   wed   thu   fri   sat} <0..23> ...	350
idp statistics flush .....	351
idp system-protect deactivate .....	341
idp white-list .....	354
iface {add   del} {interface_name   virtual_interface_name} .....	570
igmp {activate   direction {downstream   upstream}   version <1..3>} .....	152
igmp direction .....	122
igmp version <1..3> .....	122
ikev2 policy rename policy_name policy_name .....	283
ikev2 policy rename policy_name policy_name .....	284
in-dnat <1..10> protocol {all   tcp   udp} original-ip address_name <0..65535> <0..65535> mapped-ip address_name <0..65535> <0..65535> .....	275
in-dnat append protocol {all   tcp   udp} original-ip address_name <0..65535> <0..65535> mapped-ip address_name <0..65535> <0..65535> .....	275
in-dnat delete <1..10> .....	275
in-dnat insert <1..10> protocol {all   tcp   udp} original-ip address_name <0..65535> <0..65535> mapped-ip ad- dress_name <0..65535> <0..65535> .....	275
in-dnat move <1..10> to <1..10> .....	275
in-snat source address_name destination address_name snat address_name .....	275
interface .....	42
interface {num  append  insert num} interface-name [weight <1..10>  limit <1..2097152>   passive] .....	159
interface cellular budget-auto-save <5..1440> .....	140
interface dial interface_name .....	136
Interface dial wan1_ppp .....	295
Interface disconnect .....	295
interface disconnect interface_name .....	136
interface interface_name .....	127

interface <i>interface_name</i> .....	130
interface <i>interface_name</i> .....	131
interface <i>interface_name</i> .....	132
interface <i>interface_name</i> .....	133
interface <i>interface_name</i> .....	136
interface <i>interface_name</i> .....	149
interface <i>interface_name</i> .....	150
interface <i>interface_name</i> .....	151
interface <i>interface_name</i> .....	155
interface <i>interface_name</i> .....	249
Interface <i>interface_name</i> .....	295
interface <i>interface_name</i> ipv6 .....	117
interface <i>interface_name</i> no ipv6 .....	119
interface reset { <i>interface_name</i>   <i>virtual_interface_name</i>  all} .....	120
interface send statistics interval <15..3600> .....	120
interface-name { <i>ppp_interface</i>   <i>ethernet_interface</i> } <i>user_defined_name</i> .....	120
interface-rename <i>old_user_defined_name</i> <i>new_user_defined_name</i> .....	120
<i>interval</i> .....	107
ip address dhcp option-60 <text> .....	116
ip address ipv4 <i>ipv4</i> .....	143
ip dhcp pool rename <i>profile_name</i> <i>profile_name</i> .....	125
ip dhcp static <i>_import_static_file</i> <i>import file name</i> interface <i>interface name</i> ....	125
ip dns security-options {default   1}] .....	503
ip dns server aaaa-record { <i>FQDN_DNS</i>   <i>FQDN_WILDCARD_DNS</i> } IPv6 .....	502
ip dns server cache-flush .....	501
ip dns server cname-record { <i>FQDN_DNS</i>   <i>FQDN_WILDCARD_DNS</i> } { <i>FQDN_DNS</i> } .....	502
ip dns server rule {<1..32> append insert <1..32>} access-group {ALL  <i>address_object</i> } zone {ALL  <i>address_object</i> } action {accept deny} .....	501
ip dns server rule move <1..32> to <1..32> .....	502
ip dns server zone-forwarder {<1..32> append insert <1..32>} { <i>domain_zone_name</i>  *} {interface <i>interface_name</i> / user-defined <i>ipv4_address</i> [interface { <i>interface_name</i>   auto}]} 590	
ip dns server zone-forwarder {<1..32> append insert <1..32>} { <i>domain_zone_name</i>  *} user-defined <i>w.x.y.z</i> { <i>ip_type</i> } [private   interface { <i>interface_name</i>   auto}] .....	502
ip dns server zone-forwarder move <1..32> to <1..32> .....	502
ip dns server zone-forwarder move <1..32> to <1..32> .....	590
ip ftp server rule { <i>rule_number</i>  append insert <i>rule_number</i> } access-group {ALL  <i>address_object</i> } zone {ALL  <i>zone_object</i> } action {accept deny} .....	519
ip ftp server rule move <i>rule_number</i> to <i>rule_number</i> .....	519
ip gateway ip metric <0..15> .....	116
ip http secure-server cipher-suite { <i>cipher_algorithm</i> } [ <i>cipher_algorithm</i> ] [ <i>cipher_algorithm</i> ] [ <i>cipher_algorithm</i> ] .....	514
ip http secure-server table {admin user} rule { <i>rule_number</i>  append insert <i>rule_number</i> } access- group {ALL  <i>address_object</i> } zone {ALL  <i>zone_object</i> } action {accept deny} ....	514
ip http secure-server table {admin user} rule move <i>rule_number</i> to <i>rule_number</i> ...	514
ip http server table {admin user} rule { <i>rule_number</i>  append insert <i>rule_number</i> } access-group {ALL  <i>address_object</i> } zone {ALL  <i>zone_object</i> } action {accept deny} .....	514
ip http server table {admin user} rule move <i>rule_number</i> to <i>rule_number</i> .....	514
ip http skip-csrf-check .....	514
ip http-redirect activate <i>description</i> .....	199
ip http-redirect deactivate <i>description</i> .....	199
ip http-redirect <i>description</i> interface <i>interface_name</i> redirect-to <i>w.x.y.z</i> <1..65535> 199	
ip http-redirect <i>description</i> interface <i>interface_name</i> redirect-to <i>w.x.y.z</i> <1..65535> deactivate .....	199
ip http-redirect flush .....	199
ip ipnp config .....	264
ip ospf authentication .....	131
ip ospf authentication message-digest .....	131
ip ospf authentication same-as-area .....	131
ip ospf cost <1..65535> .....	155

ip ospf dead-interval <1..65535> .....	156
ip ospf hello-interval <1..65535> .....	156
ip ospf message-digest-key <1..255> md5 <i>password</i> .....	131
ip ospf retransmit-interval <1..65535> .....	156
ip route replace { <i>w.x.y.z</i> } { <i>w.x.y.z</i> } { <i>interface w.x.y.z</i> } <0..127> with { <i>w.x.y.z</i> } { <i>w.x.y.z</i> } { <i>interface w.x.y.z</i> } <0..127> .....	170
ip ssh server rule { <i>rule_number append insert rule_number</i> } access-group {ALL  <i>address_object</i> } zone {ALL  <i>zone_object</i> } action {accept deny} .....	516
ip ssh server rule move <i>rule_number</i> to <i>rule_number</i> .....	516
ip telnet server rule { <i>rule_number append insert rule_number</i> } access-group {ALL  <i>address_object</i> } zone {ALL  <i>zone_object</i> } action {accept deny} .....	518
ip telnet server rule move <i>rule_number</i> to <i>rule_number</i> .....	518
ip virtual-server {activate   deactivate} <i>profile_name</i> .....	187
ip virtual-server delete <i>profile_name</i> .....	187
ip virtual-server flush .....	187
ip virtual-server load-balancer name .....	194
ip virtual-server load-balancer rename <i>old_name new_name</i> .....	196
ip virtual-server <i>profile_name</i> interface <i>interface_name</i> original-ip {any   IP   <i>address_object</i> } map-to { <i>address_object</i>   ip} map-type original-service <i>service_object</i> mapped-service <i>service_object</i> [nat-loopback [nat-1-1-map] [deactivate]   nat-1-1-map [deactivate]   deactivate] .....	187
ip virtual-server <i>profile_name</i> interface <i>interface_name</i> original-ip {any   IP   <i>address_object</i> } map-to { <i>address_object</i>   ip} map-type port protocol {any   tcp   udp} original-port <1..65535> mapped-port <1..65535> [nat-loopback [nat-1-1-map] [deactivate]   nat-1-1-map [deactivate]   deactivate] .....	186
ip virtual-server <i>profile_name</i> interface <i>interface_name</i> original-ip {any   IP   <i>address_object</i> } map-to { <i>address_object</i>   ip} map-type ports protocol {any   tcp   udp} original-port-begin <1..65535> original-port-end <1..65535> mapped-port-begin <1..65535> [nat-loopback [nat-1-1-map] [deactivate]   nat-1-1-map [deactivate]   deactivate] .....	186
ip virtual-server <i>profile_name</i> interface <i>interface_name</i> source-ip {any   IPv4   <i>address-object</i> } original-ip {any   ip   <i>address_object</i> } map-to { <i>address_object</i>   ip} map-type any [nat-loopback [nat-1-1-map] [deactivate]   nat-1-1-map [deactivate]   deactivate] .....	186
ip virtual-server rename <i>profile_name profile_name</i> .....	187
ip6 route <i>destv6/prefix</i> { <i>ipv6_global_address</i>   <i>ipv6_link_local</i>   <i>interface</i> } [<0..127>] .....	170
ip6 route <i>destv6/prefix</i> { <i>ipv6_link_local interface</i> } [<0..127>] .....	170
ip6 route replace <i>destv6/prefix</i> { <i>gatewayv6</i>   <i>interface</i> } [<0..127>] with <i>destv6/prefix</i> { <i>gatewayv6</i>   <i>interface</i> } [<0..127>] .....	170
<i>ip_address</i> .....	103
ip-reputation action {block   pass} .....	320
ip-reputation action-level {high   medium   low} .....	320
ip-reputation black-list {IPv4 IPv4CIDR} {activate deactivate} .....	321
ip-reputation black-list replace <1..256> IPv4 {activate deactivate} .....	321
ip-reputation ebl < <i>profile name</i> > .....	323
ip-reputation ebl rename <i>old_profile_name new_profile_name</i> .....	323
ip-reputation ebl update .....	324
ip-reputation ebl update daily <0..23> .....	323
ip-reputation ebl update hourly .....	323
ip-reputation ebl update weekly { <i>sun  mon tue wed thu fri sat</i> } <0..23> .....	324
ip-reputation statistics flush .....	322
ip-reputation update daily <0..23> .....	322
ip-reputation update hourly .....	322
ip-reputation update signatures .....	322
ip-reputation update weekly { <i>sun   mon   tue   wed   thu   fri   sat</i> } <0..23> .....	322
ip-reputation white-list {IPv4 IPv4CIDR} {activate deactivate} .....	321
ip-reputation white-list replace <1..256> IPv4 {activate deactivate} .....	321
ipsec-isakmp <i>policy_name</i> .....	274
ipsec-isakmp <i>policy_name</i> .....	285
ipv6 6to4 [prefix <i>ipv6_addr_prefix</i>   destination-prefix <i>ipv4_cidr</i>   relay <i>ipv4</i> ] .....	144
ipv6 address <i>dhcp6_profile dhcp6_suffix_128</i> .....	118

ipv6 address <i>dhcp6_profile dhcp6_suffix_128</i> .....	119
ipv6 address <i>ipv6_addr_prefix</i> .....	144
ipv6 dhcp6 [client] .....	137
ipv6 dhcp6 duid { <i>duid</i>   <i>mac</i> } .....	137
ipv6 neighbor flush { <i>ipv6</i>   <i>all</i> } .....	572
ip-version {ip ip6 any} .....	570
isakmp policy rename <i>policy_name policy_name</i> .....	273
keystring <i>pre_shared_key</i> .....	272
keystring pre_shared_key .....	282
keystring pre_shared_key .....	284
l2-isolation .....	213
l2tp-over-ipsec <i>address-object</i> .....	294
l2tp-over-ipsec authentication <i>authentication profile_name</i> .....	294
l2tp-over-ipsec crypto <i>map_name</i> .....	294
l2tp-over-ipsec recover default-ipsec-policy .....	294
lacp-rate {fast   slow} .....	152
language <i>language_name</i> .....	509
language update daily <0..23> .....	509
language update hourly .....	509
language update package .....	509
language update weekly {sun   mon   tue   wed   thu   fri   sat} <0..23> .....	509
<i>lan_port</i> {activate   inactivate} pvid <1..4094> .....	58
lan-provision ap <i>ap_mac</i> .....	58
lan-provision <i>lan_port</i> {activate   inactivate} pvid <1..4094> .....	57
lan-provision <i>vlan_interface</i> {activate   inactivate} vid <1..4094> join <i>lan_port</i> {tag   untag} [ <i>lan_port</i> {tag   untag}] [ <i>lan_port</i> {tag   untag}] .....	57
ldap {activate deactivate} .....	481
ldap ip { <i>ip</i>   <i>fqdn</i> } port <1..65535> [ <i>id name password password</i> ] [deactivate] .....	481
led_locator <i>ap_mac_address</i> blink-timer <1..60> .....	110
led_locator <i>ap_mac_address</i> off .....	110
led_locator <i>ap_mac_address</i> on .....	110
led_suppress <i>ap_mac_address</i> disable .....	109
led_suppress <i>ap_mac_address</i> enable .....	109
lifetime <180..3000000> .....	272
lifetime <180..3000000> .....	282
lifetime <180..3000000> .....	283
limit-ampdu <100..65535> .....	76
limit-amsdu <2290..4096> .....	76
link-monitoring {arp   mii   none} .....	151
link-sticking outgoing interface { <i>interface_name</i>   all} .....	207
load-balance-algorithm { <i>rr/wrr/lc/sh</i> } .....	195
load-balancing [slot1   slot2] alpha <1..255> .....	69
load-balancing [slot1   slot2] beta <1..255> .....	69
load-balancing [slot1   slot2] kickInterval <1..255> .....	70
load-balancing [slot1   slot2] lInterval <1..255> .....	70
load-balancing [slot1   slot2] max sta <1..127> .....	70
load-balancing [slot1   slot2] sigma <51..100> .....	70
load-balancing [slot1   slot2] timeout <1..255> .....	70
load-balancing [slot1   slot2] traffic level {high   low   medium} .....	70
load-balancing mode [slot1   slot2] {station   traffic   smart-classroom} .....	70
loadbalancing-index <inbound   outbound   total> .....	160
local-address <i>w.x.y.z</i> .....	295
local-id type {ip <i>ip</i>   fqdn <i>domain_name</i>   mail <i>e_mail</i>   dn <i>distinguished_name</i> } ..	272
local-id type {ip ip   fqdn <i>domain_name</i>   mail <i>e_mail</i>   dn <i>distinguished_name</i> } ..	282
local-id type {ip IPv6   fqdn <i>domain_name</i>   mail <i>e_mail</i>   dn <i>distinguished_name</i> } ..	284
local-ip {ip { <i>ip</i>   <i>domain_name</i> }   interface <i>interface_name</i> } .....	272
local-ip {ip {ip   <i>domain_name</i> }   interface <i>interface_name</i> } .....	282
local-ip {ip IPv6} .....	284
local-ip <i>ip</i> .....	278

local-policy <i>address_name</i> .....	274
local-policy <i>address_name</i> .....	285
location <i>location</i> .....	66
logging console category <i>module_name</i> level {alert   crit   debug   emerg   error   info   notice   warn} .....	554
logging mail <1..2> schedule daily hour <0..23> minute <0..59> .....	553
logging mail <1..2> schedule weekly day <i>day</i> hour <0..23> minute <0..59> .....	553
logging mail <1..2> sending_now .....	552
logging system-log category <i>module_name</i> {disable   level normal   level all} ....	549
logging usb-storage category <i>category</i> disable .....	146
logging usb-storage category <i>category</i> level <all normal> .....	146
logging usb-storage category <i>module_name</i> level {all   normal} .....	549
logging usb-storage delete over-keep-duration .....	549
logging usb-storage flushThreshold <1..100> .....	146
logging usb-storage flushThreshold <1..100> .....	549
logging usb-storage keep-duration day <1..365> .....	550
login-mac <i>mac_address</i> .....	494
login-page background-color { <i>color-rgb</i>   <i>color-name</i>   <i>color-number</i> } .....	497
login-page message-color { <i>color-rgb</i>   <i>color-name</i>   <i>color-number</i> } .....	497
login-page title <i>title</i> .....	497
login-page title-color { <i>color-rgb</i>   <i>color-name</i>   <i>color-number</i> } .....	497
login-page window-color { <i>color-rgb</i>   <i>color-name</i>   <i>color-number</i> } .....	498
logo background-color { <i>color-rgb</i>   <i>color-name</i>   <i>color-number</i> } .....	498
mac <i>mac</i> .....	133
mail-attach password < <i>attachment password</i> > .....	579
mail-info { <i>mail-to-1/mail-to-2/mail-to-3/mail-to-4/mail-to-5</i> } < <i>user@domainname</i> > .....	579
mail-info content < <i>mail-content</i> > .....	579
mail-server .....	505
mail-subject set <i>subject</i> .....	558
marked-interface any .....	303
marked-interface interface vlan<1..4064> .....	303
marked-interface none .....	303
marked-interface trunk <i>trunk_name</i> .....	303
max-sw-retries <0..10> .....	79
miimon <1..1000> .....	152
mode {802_3ad   active-backup   balance-alb   mode 802_3ad} .....	151
mode {main   aggressive} .....	272
mode {normal trunk} .....	160
mode-config activate .....	276
mode-config address- <i>profile_name</i> .....	276
MODULE_NAME_WTP .....	552
MODULE_NAME_WTP_ .....	552
<i>mon_dir_size</i> .....	103
monitoring flush .....	96
move <1..8> to <1..8> .....	160
mtu <576..1492> .....	137
mtu <576..1492> .....	140
multicast pps <1-10000> .....	81
multicast pps <1-10000> .....	82
myzyxel-service get-cloud-timezone .....	499
myzyxel-service set-timezone-according-cloud .....	499
name <i>description</i> .....	494
name DNS_OPTIONS_NAME .....	503
nd ra accept .....	117
nd ra accept .....	119
nd ra advertise .....	117
nd ra advertise .....	119
nd ra default-lifetime .....	119
nd ra default-lifetime <4..9000> .....	118

nd ra hop-limit .....	119
nd ra hop-limit <0..255> .....	117
nd ra managed-config-flag .....	117
nd ra managed-config-flag .....	119
nd ra max-rtr-interval .....	119
nd ra max-rtr-interval <4..1800> .....	117
nd ra min-rtr-interval .....	119
nd ra min-rtr-interval <3..1350> .....	117
nd ra mtu .....	119
nd ra mtu <1280..1500>   <0> .....	117
nd ra other-config-flag .....	117
nd ra other-config-flag .....	119
nd ra prefix-advertisement <i>dhcp6_profile dhcp6_suffix_64</i> .....	118
nd ra prefix-advertisement DHCP6_PROFILE DHCP6_SUFFIX_64 .....	119
nd ra prefix-advertisement <i>ipv6_addr_prefix</i> [ auto { on   off } ] [ link { on   off } ] [ preferred-time { <0..4294967294>   infinity } ] [ valid-time { <0..4294967294>   infinity } ] .....	117
nd ra reachable-time .....	119
nd ra reachable-time <0..3600000> .....	117
nd ra retrans-timer .....	119
nd ra retrans-timer <0..4294967295> .....	118
nd ra router-preference { low   medium   high } .....	117
network <i>ip mask</i> .....	126
network IP/<1..32> .....	126
no { <i>mail-to-1/mail-to-2/mail-to-3/mail-to-4/mail-to-5</i> } .....	579
no additional-from-cache activate .....	503
no address-object <i>object_name</i> .....	446
no address-object-group { any   PROFILE } .....	503
no anti-spam dnsbl domain <i>dnsbl_domain</i> .....	398
no anti-spam xheader { mail-content   virus-outbreak } .....	392
no anti-spam xheader mail-phishing .....	392
no anti-virus black-list { md5-hash md5-pattern   file-pattern file-pattern } .....	313
no anti-virus mail-infect-ext activate .....	310
no anti-virus white-list { md5-hash md5-pattern   file-pattern file-pattern } .....	313
no application-object <object> .....	441
no application-object <profile-name> .....	306
no area IP virtual-link IP message-digest-key <1..255> .....	175
no arp <i>ip</i> .....	573
no authentication key .....	173
no auth-server authentication .....	476
no auth-server authentication .....	504
no bind .....	230
no budget log .....	139
no budget log-percentage .....	140
no ca category { local remote } <i>certificate_name</i> .....	482
no ca validation <i>name</i> .....	482
no content-filter profile <i>filtering_profile</i> [ commtouch-url ] match { log } .....	364
no content-filter profile <i>filtering_profile</i> [ commtouch-url ] offline { log } .....	365
no content-filter profile <i>filtering_profile</i> [ commtouch-url ] unrate { log } .....	365
no content-filter profile <i>filtering_profile</i> commtouch-url match { log } .....	364
no content-filter profile <i>filtering_profile</i> commtouch-url match-unsafe { log } .....	364
no content-filter profile <i>filtering_profile</i> commtouch-url offline { log } .....	365
no content-filter profile <i>filtering_profile</i> commtouch-url unrate { log } .....	365
no description .....	230
no dhcp6-lease-object <i>dhcp6_profile</i> .....	491
no dhcp6-request-object <i>dhcp6_profile</i> .....	491
no dhcp-option <1..254> .....	126
no dns-content-filter black-list FQDN .....	367
no dns-content-filter white-list FQDN .....	368
no dns-filter black-list FQDN .....	333



no dns-filter white-list FQDN .....	334
no dscp-marking .....	165
no dscp-marking .....	166
no friendly-ap ap_mac .....	96
no icmp-decoder {bad-icmp-l4-size icmp-fragment   icmp-smurf} log .....	232
no icmp-decoder {bad-icmp-l4-size   icmp-fragment   icmp-smurf} action .....	232
no idp anomaly <profile3> .....	229
no idp anomaly rule <1..32> .....	230
no idp anomaly white-list rule-name .....	233
no idp customize signature custom_sid .....	347
no idp signature profile3 .....	342
no ip dns server rule <1..32> .....	502
no ip dns server zone-forwarder <1..4> .....	590
no ip ftp server rule rule_number .....	519
no ip http secure-server cipher-suite {cipher_algorithm} .....	514
no ip http secure-server table {admin user} rule rule_number .....	514
no ip http server table {admin user} rule rule_number .....	514
no ip http skip-csrf-check .....	515
no ip http-redirect description .....	199
no ip ospf authentication .....	131
no ip ospf message-digest-key .....	131
no ip ssh server rule rule_number .....	517
no ip telnet server rule rule_number .....	518
no ip virtual-server load-balancer name .....	196
no ip virtual-server profile_name .....	186
no ip6 route destv6/prefix { gatewayv6   interface } [<0..127>] .....	170
no ip-reputation black-list IPv4 .....	321
no ip-reputation ebl <profile name> .....	323
no ip-reputation white-list IPv4 .....	321
no l2-isolation activate .....	213
no l2-isolation white-list activate .....	213
no l2-isolation white-list rule_number .....	213
no l2tp-over-ipsec session tunnel-id <0..65535> .....	294
no mac .....	133
no mail-attach password .....	579
no mail-info content .....	579
no mail-subject set .....	558
no network .....	126
no object-group application <object> .....	442
no packet-trace .....	42
no rap slot_name ssid-profile <1..6> .....	64
no real-server address .....	195
no recursion activate .....	503
no rogue-ap ap_mac .....	96
no sa spi spi .....	281
no sa tunnel-name map_name .....	281
no scan-detection sensitivity .....	230
no schedule-object object_name .....	456
no security-service ip6-exception profile_name .....	416
no security-service ip-exception profile_name .....	416
no server-auth <1..2> .....	89
no server-type .....	488
no service-object object_name .....	453
no signature sid action .....	343
no signature sid action .....	344
no signature sid log .....	343
no smtp-address .....	557
no smtp-auth username .....	557
no snmp-server rule rule_number .....	522

no ssl-inspection profile SSI_profile_name .....	411
no sslvpn login-domain-1 .....	288
no sslvpn login-domain-2 .....	288
no sslvpn login-port .....	288
no sslvpn policy profile_name .....	289
no storm-control ethernet ap mac_address .....	82
no storm-control wireless ap mac_address .....	82
no tcp-decoder {tcp-xxx} log .....	231
no threat-website ebl <profile name> .....	328
no udp-decoder {bad-udp-l4-size   udp-land   udp-smurf} action .....	231
no udp-decoder {bad-udp-l4-size   udp-land   udp-smurf} log .....	231
no use-defined-mac .....	134
no user .....	279
no username username .....	432
no vpn-configuration-provision port .....	280
no web-auth redirect-parameter .....	246
nslookup .....	42
nslookup {ipv4   hostname} [server ipv4] [extension filter-extension] .....	562
nslookup6 {ipv6   hostname} [server ipv6] [extension filter-extension] .....	562
ntp sync .....	499
object-group address rename group_name group_name .....	450
object-group application <object> .....	442
object-group application rename <object> <object> .....	442
object-group service rename group_name group_name .....	455
ocsp {activate deactivate} .....	481
ocsp url url [id name password password] [deactivate] .....	482
output-power wlan_power .....	80
out-snat source address_name destination address_name snat address_name .....	275
packet-capture configure .....	569
packet-trace .....	42
packet-trace [interface interface_name] [[ip-proto ipv6-proto]   protocol_name   any]] [src-host {ip   hostname   any}] [dst-host {ip   hostname   any}] [port {<1..65535>   any}] [file] [duration <1..3600>] [extension-filter filter_extension] .....	569
password isp_account_password .....	295
password password .....	494
payment-info {cash   payment-service} .....	494
payment-service account-delivery delivery_method {deactivate   activate} .....	258
payment-service check paypal-currency .....	261
payment-service fail-page failed-message message .....	258
payment-service mobile-fail-page failed-message message .....	258
payment-service mobile-profile-page selection-message message .....	259
payment-service mobile-sms-page info-message message .....	259
payment-service mobile-success-page {notification-message   successful-message   notification-message-color {#00FF00   color_name   rgb(0,0,255)}} .....	259
payment-service profile-page selection-message message .....	259
payment-service provider paypal .....	258
payment-service provider paypal account e-mail .....	260
payment-service provider paypal currency paypal_currency .....	260
payment-service provider paypal exit .....	258
payment-service provider paypal gateway payment_gw_url .....	261
payment-service provider paypal identity-token paypal_token .....	260
payment-service provider paypal no account .....	260
payment-service provider paypal no identity-token .....	260
payment-service provider select provider .....	258
payment-service success-page {account-message message / format-date {dd-mm-yyyy   mm-dd-yyyy   yyyy-mm-dd}   notification-message message / notification-message-color {#00FF00   color_name   rgb(0,0,255)}   successful-message message} .....	259
peer-id type {any   ip ip   fqdn domain_name   mail e_mail   dn distinguished_name} .....	272
peer-id type {any   ip ip   fqdn domain_name   mail e_mail   dn distinguished_name} .....	282

peer-id type {any   ip IPv6   fqdn domain_name   mail e_mail   dn distinguished_name} .....	284
peer-ip {ip   domain_name} [ip   domain_name] .....	272
peer-ip {ip   domain_name} [ip   domain_name] .....	282
peer-ip {ip IPv6} .....	284
peer-ip ip .....	278
persistence granularity netmask .....	195
persistence timeout 1-86400 .....	195
phone phone_number .....	494
ping .....	42
Ping {ipv4   hostname} [source ipv4] [size <0..65507>] [forever  count <1..4096>] 570	
ping {ipv4_addr   hostname} [source ipv4] [size <0..65507>] [forever   count <1..4096>] [in- interface interface_name] [extension filter-extension] .....	571
ping6 .....	42
ping6 {ipv6   hostname} [source ipv6] [size <0..65527>] [forever  count <1..4096>] [interface {interface_name   virtual_interface_name}] [extension filter_extension] ....	571
ping-check .....	152
ping-check {domain_name   ip} .....	155
ping-check {domain_name   ip} fail-tolerance <1..10> .....	155
ping-check {domain_name   ip} method {icmp   tcp} .....	155
ping-check {domain_name   ip} period <5..30> .....	155
ping-check {domain_name   ip} port <1..65535> .....	155
ping-check {domain_name   ip} timeout <1..10> .....	155
ping-check {FQDN   IPv4   default-gateway} [period <5..3600>] [timeout <1..10>] [fail-tolerance <1..10>] [method {icmp   tcp}] [port <1..65535>] [probe-condition {any   all}] .....	132
pn-check-thres <0..100> .....	80
policy {policy_number   append   insert policy_number} .....	164
policy default-route .....	167
policy delete policy_number .....	167
policy flush .....	167
policy list table .....	167
policy move policy_number to policy_number .....	167
policy6 {policy_number   append   insert policy_number} .....	166
port <1..65535> ending-port <1..65535>] .....	488
port <1..65535> ending-port <1..65535>] [program-path program-path] .....	488
port status Port<1..x> .....	134
price price .....	256
printer-ip ip_address .....	494
printer-ip ipv4_address .....	262
printer-manager button {a   b   c} profile_name .....	261
printer-manager discover .....	261
printer-manager encrypt secret-key secret_key .....	261
printer-manager multi-printout <1..3> .....	261
printer-manager port <1..65535> .....	261
printer-manager printer append .....	261
printer-manager printout-type {customized   default} .....	262
priority-code <0..7> .....	303
proto-type {icmp   icmp6   igmp   igmp   pim   ah   esp   vrrp   udp   tcp   any} .....	570
psk psk .....	94
psm .....	42
pwd-expiry expiration send-now .....	433
pwd-expiry link-to-device custom {myrouter   <FQDN>   <IPv6 Address>   <W.X.Y.X>} .....	433
quit .....	177
quota {total   upload   download} gigabytes <0..100> .....	256
quota {total   upload   download} gigabytes <0..100> .....	495
quota {total   upload   download} megabytes <0..1023> .....	256
quota {total   upload   download} megabytes <0..1023> .....	494
quota type {total   upload-download} .....	256
quota type {total   upload-download} .....	495
rap slot_name output-power wlan_power .....	64

<code>rap slot_name ssid-profile &lt;1..6&gt; ssid_profile_name [tunlif interface] vid vlan_id</code>	64
<code>real-server address mapped-port port weight weight [hash hash]</code>	195
<code>reboot</code>	42
<code>redirect-service &lt;1..20&gt;</code>	201
<code>redirect-service append &lt;1..20&gt;</code>	201
<code>redirect-service flush</code>	202
<code>redirect-service insert &lt;1..20&gt;</code>	202
<code>redirect-service move &lt;1..20&gt; to &lt;1..20&gt;</code>	202
<code>redistribute {static   ospf} metric &lt;0..16&gt;</code>	173
<code>release</code>	42
<code>release dhcp interface-name</code>	127
<code>remaining-time &lt;1..25920000&gt;</code>	495
<code>remote-assistance [address1 address2] ipv4</code>	563
<code>remote-assistance [https ssh] port port</code>	563
<code>remote-assistance generate user-password</code>	563
<code>remote-assistance remove {address1 address2}</code>	563
<code>remote-assistance schedule DATE TIME date time</code>	563
<code>remote-assistance settings [random manual]</code>	563
<code>remote-assistance user-object user</code>	563
<code>remote-policy address_name</code>	274
<code>remote-policy address_name</code>	285
<code>rename</code>	42
<code>rename {/conf   /idp   /packet_trace   /script   /tmp}/old-file_name {/conf   /idp   /packet_trace   /script   /tmp}/new-file_name</code>	529
<code>rename /script/old-file_name /script/new-file_name</code>	529
<code>renew</code>	42
<code>renew dhcp interface-name</code>	127
<code>replenish enable</code>	495
<code>report packet size statistics clear</code>	557
<code>reset-counter-now</code>	558
<code>respsmsg url-filter block-page background-color {&lt;rgb(0,0,255)&gt;   &lt;color name&gt;   &lt;#00FF00&gt;}</code>	508
<code>respsmsg url-filter block-page banner-color {&lt;rgb(0,0,255)&gt;   &lt;color name&gt;   &lt;#00FF00&gt;}</code>	508
<code>respsmsg url-filter block-page banner-message-color {&lt;rgb(0,0,255)&gt;   &lt;color name&gt;   &lt;#00FF00&gt;}</code>	508
<code>respsmsg url-filter block-page message-color {&lt;rgb(0,0,255)&gt;   &lt;color name&gt;   &lt;#00FF00&gt;}</code>	508
<code>retry 1-99</code>	196
<code>ring-buffer &lt;enable disable&gt;</code>	570
<code>rogue-ap ap_mac description2</code>	96
<code>rogue-ap containment</code>	98
<code>rogue-ap detection</code>	95
<code>role wlan_role</code>	80
<code>router bgp</code>	177
<code>router ospf</code>	131
<code>router ospf</code>	173
<code>router ospf</code>	174
<code>router ospf</code>	174
<code>router rip</code>	130
<code>router rip</code>	173
<code>Router(config)#</code>	108
<code>Router(config)#</code>	510
<code>Router(config)# auto-healing activate</code>	108
<code>Router(config)# auto-healing power-threshold -70</code>	108
<code>Router(config)# show auto-healing config</code>	108
<code>Router(config)# zon lldp server</code>	510
<code>Router(config)# zon lldp server status</code>	510
<code>router(config-ss0-primary)#</code>	251
<code>router(config-ss0-primary)#</code>	251
<code>router(config-ss0-secondary)#</code>	251

<code>router(config-ss0-secondary)# [no] port &lt;1025..65535&gt;</code>	251
<code>Router(SIP Signaling Port)# [no] port &lt;1025..65535&gt;</code>	205
<code>rsi-dbm &lt;-20~-76&gt;</code>	80
<code>rsi-interval (1..86400)</code>	80
<code>rsi-kickout &lt;-20~-105&gt;</code>	80
<code>rsi-optype &lt;0-3&gt;</code>	80
<code>rsi-privilegetime</code>	80
<code>rsi-retrycount &lt;1~100&gt;</code>	80
<code>rsi-verifytime</code>	80
<code>rtls ekahau ip address &lt;ip&gt;</code>	318
<code>rtls ekahau ip port &lt;1..65535&gt;</code>	318
<code>run</code>	42
<code>run /script/file_name.zysh</code>	529
<code>rx-mask chain_mask</code>	80
<code>sandbox dashboard statistics flush</code>	336
<code>sandbox dashboard statistics flush</code>	337
<code>sandbox file-scanning-log {log   log-alert   no}</code>	336
<code>sandbox file-send-log {log   log-alert   no}</code>	336
<code>sandbox malicious-action malicious {allow   destroy} {log   log-alert   no}</code>	336
<code>sandbox malicious-action suspicious {allow   destroy} {log   log-alert   no}</code>	336
<code>sandbox mdb flush</code>	336
<code>sandbox response-clean-log {log   log-alert   no}</code>	337
<code>sandbox server-file {delete   keep}</code>	337
<code>sandbox statistics flush</code>	337
<code>scan-detection block-period &lt;1..3600&gt;</code>	230
<code>scan-detection sensitivity {low   medium   high}</code>	230
<code>scan-dwell &lt;100..1000&gt;</code>	83
<code>scan-method scan_method</code>	82
<code>scenario {site-to-site-static   site-to-site-dynamic   remote-access-server   remote-access-client}</code>	274
<code>scenario {site-to-site-static   site-to-site-dynamic   remote-access-server   remote-access-client}</code>	285
<code>schedule hour &lt;0..23&gt; minute &lt;00..59&gt;</code>	505
<code>schedule hour &lt;0..23&gt; minute &lt;00..59&gt;</code>	558
<code>schedule reboot daily &lt;time,hh:mm&gt;</code>	577
<code>schedule reboot monthly &lt;time,hh:mm&gt; &lt;day,dd&gt;</code>	577
<code>schedule reboot weekly &lt;time,hh:mm&gt; {sun/mon/tue/wed/thu/fri/sat}</code>	577
<code>schedule schedule_object</code>	80
<code>schedule-object object_name date time date time</code>	457
<code>schedule-object object_name time time [day] [day] [day] [day] [day] [day] [day]</code>	457
<code>scheduler daily &lt;time,hh:mm&gt;</code>	579
<code>scheduler monthly &lt;time,hh:mm&gt; &lt;day,dd&gt;</code>	579
<code>scheduler weekly &lt;time,hh:mm&gt; {sun/mon/tue/wed/thu/fri/sat}</code>	579
<code>schedule-run 1 file_name.zysh {daily   monthly   weekly} time {date   sun   mon   tue   wed   thu   fri   sat}</code>	529
<code>secure policy &lt;1..500&gt; device &lt;profile name&gt;</code>	430
<code>secure-policy &lt;profile name&gt;</code>	220
<code>secure-policy activate</code>	216
<code>secure-policy append</code>	217
<code>secure-policy backup activate</code>	216
<code>secure-policy default-rule action {allow   deny   reject} { no log   log [alert] }</code>	217
<code>secure-policy delete rule_number</code>	217
<code>secure-policy flush</code>	217
<code>secure-policy insert rule_number</code>	217
<code>secure-policy move rule_number to rule_number</code>	217
<code>secure-policy rule_number</code>	217
<code>secure-policy zone_object {zone_object ZyWALL} append</code>	217
<code>secure-policy zone_object {zone_object ZyWALL} delete &lt;1..5000&gt;</code>	217
<code>secure-policy zone_object {zone_object ZyWALL} flush</code>	217
<code>secure-policy zone_object {zone_object ZyWALL} insert rule_number</code>	217
<code>secure-policy zone_object {zone_object ZyWALL} move rule_number to rule_number</code>	217

secure-policy zone_object {zone_object ZyWALL} rule_number .....	217
secure-policy6 append .....	218
secure-policy6 default-rule action {allow   deny   reject} { no log   log [alert] }	219
secure-policy6 delete rule_number .....	219
secure-policy6 flush .....	219
secure-policy6 insert rule_number .....	219
secure-policy6 move rule_number to rule_number .....	219
secure-policy6 rule_number .....	218
secure-policy6 zone_object {zone_object ZyWALL} append .....	218
secure-policy6 zone_object {zone_object ZyWALL} delete <1..5000> .....	218
secure-policy6 zone_object {zone_object ZyWALL} flush .....	218
secure-policy6 zone_object {zone_object ZyWALL} insert rule_number .....	218
secure-policy6 zone_object {zone_object ZyWALL} move rule_number to rule_number ..	218
secure-policy6 zone_object {zone_object ZyWALL} rule_number .....	218
secure-policy-style {general   advance} .....	222
secure-policy-style advance all-inspect-by-policy .....	222
secu-reporter activate {no   yes} .....	241
secu-reporter traffic-log {activate   deactivate} .....	241
secu-reporter upload-filesize <1..10> .....	241
secu-reporter upload-interval <60..600> .....	241
security-service anti-spam inspect {all-traffic   by-policy} .....	394
security-service anti-virus inspect {all-traffic   by-policy} .....	311
security-service dns-filter inspect {all-traffic   by-policy} .....	335
security-service ip6-exception {profile_name} .....	416
security-service ip-exception {profile_name} .....	416
security-service ips inspect {all-traffic   by-policy} .....	341
security-service threat-website inspect {all-traffic   by-policy} .....	326
send-now .....	558
serial-number number .....	495
server {domain_name   w.x.y.z} .....	295
server-type {file-sharing   owa   web-server} url URL [entry-point entry_point] ..	487
server-type file-sharing share-path share-path .....	488
server-type rdp server-address server-address [starting- .....	488
server-type vnc server-address server-address [starting- .....	488
server-type weblink url url .....	488
service-object object_name {tcp   udp} {eq <1..65535>   range <1..65535> <1..65535>} 453	
service-object object_name icmp icmp_value .....	454
service-object object_name icmpv6 {<0..255>   neighbor-solicitation   router-advertisement   echo   packet-toobig   router-solicitation   echo-reply   parameter-problem   time-ex- ceeded   neighbor-advertisement   redirect   unreachable} .....	454
service-object object_name protocol <1..255> .....	454
service-object rename object_name object_name .....	454
service-register checkexpire .....	53
service-register _setremind {after-10-days   after-180-days   after-30-days   every-time   nev- er} .....	53
session timeout {udp-connect <1..300>   udp-deliver <1..300>   icmp <1..300>} ...	564
session timeout session {tcp-established   tcp-synrecv   tcp-close   tcp-finwait   tcp-synsent   tcp-closewait   tcp-lastack   tcp-timewait} <1..300> .....	564
session-limit append .....	227
session-limit delete rule_number .....	227
session-limit flush .....	227
session-limit insert rule_number .....	227
session-limit limit <0..8192> .....	227
session-limit move rule_number to rule_number .....	227
session-limit rule_number .....	227
session-limit6 append .....	228
session-limit6 delete rule_number .....	228
session-limit6 flush .....	228
session-limit6 insert rule_number .....	228

session-limit6 limit <0..8192>	227
session-limit6 move rule_number to rule_number	228
session-limit6 rule_number	227
session-page {activate   deactivate}	246
session-status-update alg {active inactive}	219
session-status-update reply-time <5..300>	219
set firmware boot number <1..2>	530
set firmware boot option <0..1>	530
set pfs {group1   group2   group5   none}	274
set pfs {group1   group2   group5   none}	285
set security-association lifetime seconds <180..3000000>	274
set security-association lifetime seconds <180..3000000>	285
set session-key {ah <256..4095> auth_key   esp <256..4095> [cipher enc_key] authenticator auth_key}	278
setenv	42
setenv-startup stop-on-error off	529
show	125
show	302
show	391
show	42
show	505
show [all]	311
show {address-object   address6-object   service-object   schedule-object} [object_name]	446
show aaa authentication {group-name default}	465
show aaa group server ad group-name	460
show aaa group server ldap group-name	462
show aaa group server radius group-name	463
show access-page settings	498
show account [pppoe profile_name   pptp profile_name]	484
show account cellular profile_name	485
show account l2tp [profile_name]	295
show ad-server	458
show advertisement	268
show advertisement activation	268
show anti-botnet dashboard statistics summary	50
show anti-botnet signature update	329
show anti-botnet signatures date	324
show anti-botnet signatures number	324
show anti-botnet signatures version	325
show anti-botnet statistics collect status	331
show anti-botnet statistics recent-activities	331
show anti-botnet statistics summary	331
show anti-botnet status	325
show anti-botnet update status	329
show anti-spam black-list [status]	396
show anti-spam dashboard statistics summary	50
show anti-spam dnsbl domain	398
show anti-spam dnsbl ip-check-order	398
show anti-spam dnsbl max-query-ip	398
show anti-spam dnsbl query-timeout {smtp   pop3}	398
show anti-spam dnsbl query-timeout time	399
show anti-spam dnsbl statistics	399
show anti-spam dnsbl status	398
show anti-spam ip-reputation high-sensitivity	393
show anti-spam ip-reputation private-check	393
show anti-spam ip-reputation query-timeout time	393
show anti-spam ip-reputation statistics	401
show anti-spam mail-phishing query-timeout pop3	393
show anti-spam mail-phishing query-timeout smtp	393
show anti-spam mail-phishing query-timeout time	393

show anti-spam mail-phishing status	393
show anti-spam mail-scan query-timeout pop3	393
show anti-spam mail-scan query-timeout smtp	393
show anti-spam mail-scan query-timeout time	393
show anti-spam mail-scan statistics	401
show anti-spam mail-scan status	393
show anti-spam profile [rule_number]	391
show anti-spam statistics collect	400
show anti-spam statistics ranking {source   mail-address}	401
show anti-spam statistics summary	400
show anti-spam tag {dnsbl   dnsbl-timeout}	399
show anti-spam tag {mail-content   mail-phishing   virus-outbreak}	393
show anti-spam tag black-list	396
show anti-spam tag mail-phishing	393
show anti-spam tag query-timeout	393
show anti-spam white-list [status]	396
show anti-spam xheader {mail-content   mail-phishing   virus-outbreak}	394
show anti-spam xheader {white-list   black-list}	397
show anti-spam xheader dnsbl	399
show anti-spam xheader mail-phishing	394
show anti-spam xheader query-timeout	394
show anti-virus black-list	312
show anti-virus black-list status	312
show anti-virus cloud-query ftype-identify status	310
show anti-virus cloud-query status	310
show anti-virus eicar activation	310
show anti-virus profile	312
show anti-virus profile [profile_name]	312
show anti-virus scan mode status	310
show anti-virus search signature {all   name virus_name} [{from id to id}]	314
show anti-virus signatures status	315
show anti-virus skip-unknown-file-type activation	310
show anti-virus statistics collect	316
show anti-virus statistics ranking {destination   destination6   source   source6   virus-name}	316
show anti-virus statistics summary	316
show anti-virus statistics summary	50
show anti-virus update	315
show anti-virus update status	315
show anti-virus white-list	313
show anti-virus white-list status	313
show ap-group first-priority	70
show ap-group-profile {all   ap_group_profile_name}	70
show ap-group-profile ap_group_profile_name lan-provision interface {all   vlan   ethernet   ap_lan_port   vlan_interface} model {nwa5301-nj   wac6502d-e   wac6502d-s   wac6503d-s   wac6553d-e}	71
show ap-group-profile ap_group_profile_name lan-provision model	71
show ap-group-profile ap_group_profile_name load-balancing config	70
show ap-group-profile rule_count	71
show ap-info {mac_address   all} {sta   usage} {24G   5G   all} timer	46
show ap-info top 10 alert {2.4G   5G   all}	99
show ap-info top number {sta   usage} timer	46
show ap-info total {sta   usage} {24G   5G   all} timer	46
show app category <category_id>	306
show app profiles	306
show app profiles <profile-name>	306
show app profiles <profile-name> application	306
show app profiles <profile-name> application category {category_id   all}	306
show app search-name <application_keyword>	306



---

show app signature update .....	307
show app signatures date .....	307
show app signatures status .....	307
show app signatures version .....	307
show app statistics collect .....	307
show app statistics summary .....	307
show app tag info .....	307
show app update status .....	307
show application-object <object> .....	441
show app-watch-dog config .....	582
show app-watch-dog monitor-list .....	582
show app-watch-dog reboot-log .....	582
show arp-table .....	573
show auth-server status .....	477
show auth-server status .....	504
show auth-server trusted-client .....	477
show auth-server trusted-client .....	504
show auth-server trusted-client <i>profile_name</i> .....	477
show auth-server trusted-client <i>profile_name</i> .....	504
show auto-healing config .....	108
show bgp [global   neighbor] .....	178
show bgp [summary   route   mem] .....	178
show billing discount default rule .....	255
show billing discount rule .....	255
show billing discount status .....	255
show billing profile [ <i>profile_name</i> ] .....	255
show billing status .....	255
show boot status .....	46
show bridge available member .....	150
show bwm activation .....	167
show bwm activation .....	300
show bwm all .....	300
show bwm applications list .....	300
show bwm default .....	300
show bwm highest sip bandwidth priority .....	300
show bwm-usage < [policy-route <i>policy_number</i> ]   [interface <i>interface_name</i> ] .....	167
show ca category {local remote} .....	482
show ca category {local remote} name <i>certificate_name</i> certpath .....	482
show ca category {local remote} name <i>certificate_name</i> format {text pem} .....	482
show ca hierarchy name <i>certificate_name</i> [format all   cn   file] .....	482
show ca spaceusage .....	482
show ca validation name <i>name</i> .....	482
show capwap ap {all   <i>ap_mac</i> } .....	58
show capwap ap {all   <i>ap_mac</i> } .....	59
show capwap ap {all   <i>ap_mac</i> } config .....	58
show capwap ap {all   <i>ap_mac</i> } config status .....	59
show capwap ap ac-ip .....	588
show capwap ap ac-ip .....	59
show capwap ap all lite2 .....	105
show capwap ap all statistics .....	59
show capwap ap <i>ap_mac slot_name</i> detail .....	59
show capwap ap discovery-type .....	588
show capwap ap fallback .....	59
show capwap ap fallback interval .....	59
show capwap ap idle timeout .....	59
show capwap ap info .....	588
show capwap ap wait-list .....	59
show capwap manual-add .....	59
show capwap station all .....	59

---

show cdr block-list .....	407
show cdr event-list .....	407
show cdr rules .....	407
show cdr signature .....	407
show cdr status .....	407
show cdr update .....	407
show cdr white-list .....	407
show clock date .....	500
show clock status .....	500
show clock time .....	500
show cloud-helper autoupdate firmware .....	533
show cloud-helper firmware .....	533
show cloud-helper highlight .....	533
show cloud-helper notify_all .....	533
show cloud-helper remind .....	533
show cloud-helper retry .....	533
show cnm-agent configuration .....	237
show comport status .....	46
show config-backup status .....	579
show config-backup status .....	579
show conn [user {username any unknown}] [service {service-name any unknown}] [source {ip any}] [destination {ip any}] [begin <1..128000>] [end <1..128000>] [dstcc {country-code any}] [srtcc {country-code any}] fastpath .....	556
show conn ip-traffic destination .....	556
show conn ip-traffic source .....	556
show conn status .....	556
show connectivity-check continuous-log status .....	132
show connectivity-check continuous-log status .....	549
show console .....	500
show content-filter common-list {trust forbid} .....	362
show content-filter dashboard statistics summary .....	50
show content-filter https-domain-filter status .....	362
show content-filter passed warning .....	362
show content-filter profile .....	366
show content-filter profile [filtering_profile] .....	366
show content-filter profile [filtering_profile] commtouch .....	366
show content-filter profile commtouch .....	366
show content-filter safesearch .....	366
show content-filter settings .....	362
show content-filter statistics collect .....	367
show content-filter statistics summary .....	366
show content-filter statistics summary .....	367
show corefile copy usb-storage .....	146
show country-code list .....	59
show cpu all .....	46
show cpu average .....	561
show cpu status .....	46
show cpu-temperature-monitor status .....	51
show crypto boost-tcp .....	271
show crypto map [map_name] .....	273
show crypto map6 [map_name] .....	284
show daily-report status .....	557
show ddns [profile_name] .....	183
show ddns-status .....	183
show default country-code .....	59
show device identify status .....	429
show device info all .....	429
show device info ip <ip address> .....	429
show device info mac <mac address> .....	429

show device profile <profile name>	429
show device profile all	429
show device-ha ap-mode backup sync	421
show device-ha ap-mode backup sync status	421
show device-ha ap-mode backup sync summary	421
show device-ha ap-mode forwarding-port <i>interface_name</i>	421
show device-ha ap-mode interfaces	421
show device-ha ap-mode master sync	421
show device-ha ap-mode next-sync-time	421
show device-ha ap-mode status	421
show device-ha mode	421
show device-ha status	419
show device-ha2 activation	424
show device-ha2 device-status	424
show device-ha2 firmware-update check-timeout	425
show device-ha2 firmware-update delay	425
show device-ha2 firmware-update status	425
show device-ha2 interfaces	425
show device-ha2 log	425
show device-ha2 mgnt-iface	425
show device-ha2 mode	424
show device-ha2 passive device-status	424
show device-ha2 passive log	425
show device-ha2 passive trace-log	425
show device-ha2 schedule-reboot check-timeout	578
show device-ha2 schedule-reboot delay	578
show device-ha2 status	425
show device-ha2 sync status	425
show device-ha2 sync summary	425
show device-ha2 trace-log	425
show device-ha2 virtual-mac	425
show device-register status	53
show dhcp6 interface	490
show dhcp6 lease-object [ <i>dhcp6_profile</i> ]	490
show dhcp6 object-binding <i>interface_name</i>	490
show dhcp6 request-object [ <i>dhcp6_profile</i> ]	490
show diag-info	561
show diag-info copy usb-storage	146
show disk	46
show dns-content-filter {white-list   black-list}	368
show dns-content-filter dashboard statistics summary	368
show dns-content-filter fake-dns-response-ttl	368
show dns-content-filter profile {all   profileName}	368
show dns-content-filter search FQDN	368
show dns-content-filter statistics collect	370
show dns-content-filter statistics list	370
show dns-content-filter statistics summary	370
show dns-content-filter status	368
show dns-filter {white-list black-list}	334
show dns-filter dashboard statistics summary	334
show dns-filter fake-dns-response-ttl	335
show dns-filter profile {all   profilename}	335
show dns-filter search FQDN	335
show dns-filter statistics collect	335
show dns-filter statistics list	335
show dns-filter statistics summary	335
show dns-filter status	335
show dynamic-guest log	494
show dynamic-guest log create-time begin yyyy-mm-dd hh:mm end yyyy-mm-dd hh:mm	494

show dynamic-guest users	494
show extension-slot	46
show fast forwarding status	511
show fbwifi activate	250
show fbwifi service-register status	250
show fbwifi status	250
show firewall icsa status	218
show firmware image boot option	530
show fqdn	447
show fqdn	498
show fqdn-object all	447
show fqdn-object query-period	447
show fqdn-object sync-period	447
show fqdn-object6 all	447
show frame-capture config	104
show frame-capture status	104
show free-time status	263
show geo-ip country-code	451
show geo-ip country-list region code	451
show geo-ip database update	451
show geo-ip database version	451
show geo-ip database version country	451
show geo-ip geography	451
show geo-ip geography6	451
show geo-ip region-code	451
show groupname [groupname]	434
show gui-visibility status	586
show hardware-watchdog-timer status	580
show idp	341
show idp {signature   anomaly} base profile	342
show idp anomaly adp-profile ip-decoder {ip-spoof   ip-teardrop} details	233
show idp anomaly adp-profile ip-decoder all details	233
show idp anomaly base profile	229
show idp anomaly profile flood-detection [all details]	232
show idp anomaly profile flood-detection {tcp-flood   udp-flood   icmp-flood   icmp-flood} details	232
show idp anomaly profile icmp-decoder {bad-icmp-l4-size   icmp-smurf} details	233
show idp anomaly profile icmp-decoder all details	233
show idp anomaly profile scan-detection [all details]	232
show idp anomaly profile scan-detection {tcp-portscan   tcp-portscan-syn   tcp-portswEEP   tcp-portscan-fin} details	232
show idp anomaly profile scan-detection {udp-portscan} details	232
show idp anomaly profile tcp-decoder {bad-tcp-flag   bad-tcp-l4-size   tcp-land} details	233
show idp anomaly profile tcp-decoder all details	232
show idp anomaly profile udp-decoder {bad-udp-l4-size   udp-land   udp-smurf} details	233
show idp anomaly profile udp-decoder all details	233
show idp anomaly profiles	230
show idp anomaly rules	230
show idp anomaly rules	230
show idp anomaly white-list {all   rule-name}	234
show idp dashboard statistics summary	50
show idp engine version	342
show idp rate_based_sig <profile name>	341
show idp search signature my_profile name quoted_string sid SID severity severity_mask platform platform_mask classtype classtype_mask service service_mask activate {any   yes   no} log {any   no   log   log-alert} action action_mask	345
show idp signature all details	342
show idp signature base profile {all none wan lan dmz} settings	342
show idp signature mode	342

show idp signature <i>profile</i> signature all details	342
show idp signature <i>profile</i> signature sid details	342
show idp signature profiles	342
show idp signature signatures {version   date   number}	350
show idp signature update	350
show idp signature update status	350
show idp signatures custom-signature all details	347
show idp signatures custom-signature <i>custom_sid</i> {details   contents   non-contents}	347
show idp signatures custom-signature number	347
show idp signatures date	351
show idp signatures number	351
show idp signatures version	351
show idp statistics collect	352
show idp statistics collect status	352
show idp statistics ranking {signature-name   source   source6   destination   destination6   rate-based}	352
show idp statistics summary	352
show idp white-list	354
show ikev2 policy [ <i>policy_name</i> ]	281
show ikev2 policy6 [ <i>policy_name</i> ]	283
show interface {ethernet   vlan   bridge   ppp} status	115
show interface { <i>interface_name</i>   ethernet   vlan   bridge   ppp   virtual ethernet   virtual vlan   virtual bridge   all}	115
show interface cellular [ <i>corresponding-slot</i>   <i>device-status</i>   <i>support-device</i> ]	140
show interface cellular budget-auto-save	140
show interface cellular corresponding-slot	140
show interface cellular device-status	140
show interface cellular status	140
show interface cellular support-device	140
show interface <i>interface_name</i> [budget]	141
show interface <i>interface_name</i> device profile	141
show interface <i>interface_name</i> device status	141
show interface <i>interface_name</i> proxy-arp address	124
show interface <i>interface_name</i> proxy-arp status	124
show interface lag	152
show interface lagx	152
show interface ppp	295
show interface ppp system-default	137
show interface ppp user-define	137
show interface send statistics interval	116
show interface summary all	116
show interface summary all status	116
show interface tunnel status	144
show interface <i>tunnel_iface</i>	144
show interface vti	157
show interface vtix	157
show interface-group {system-default user-define  <i>group-name</i> }	159
show interface-name	120
show ip bgp neighbor <i>ipv4</i> [advertised-routes   prefix-counts   routes]	178
show ip dhcp binding [ <i>ip</i> ]	127
show ip dhcp dhcp-options	124
show ip dhcp list interface {all   <i>interface name</i> } keyword <i>keyword</i>	124
show ip dhcp pool [ <i>profile_name</i> ]	124
show ip dhcp pool <i>profile_name</i> dhcp-options	125
show ip dhcp static interface {all   <i>interface name</i> }	124
show ip dns security-options all	502
show ip dns server	502
show ip dns server database	502
show ip dns server status	502

show ip ftp server status	519
show ip http server secure status	515
show ip http server status	515
show ip http skip-csrf-check	515
show ip http-redirect [description]	199
show ip ipnp activation	265
show ip ipnp interface	265
show ip route [kernel   connected   static   ospf   rip   bgp]	175
show ip route bgp	178
show ip route control-virtual-server-rules	170
show ip route static-dynamic	565
show ip route-settings	170
show ip ssh server status	517
show ip telnet server status	518
show ip virtual-server [profile_name]	186
show ip virtual-server load-balancer name	197
show ip virtual-server load-balancer name real-server	197
show ip virtual-server load-balancer statistics name	197
show ip virtual-server load-balancer statistics rate name	197
show ip-reputation {white-list black-list}	321
show ip-reputation {white-list black-list} status	321
show ip-reputation dashboard statistics summary	50
show ip-reputation ebl	324
show ip-reputation ebl <1..4> {date   number}	324
show ip-reputation ebl <profile name>	324
show ip-reputation ebl signature update	324
show ip-reputation search {Ipv6Address   Ipv4Address}	322
show ip-reputation signature update	322
show ip-reputation signatures date	320
show ip-reputation signatures number	321
show ip-reputation signatures version	321
show ip-reputation statistics collect status	322
show ip-reputation statistics recent-activities	322
show ip-reputation statistics summary	322
show ip-reputation status	320
show ip-reputation update status	322
show ip-reputation webroot {incoming-category   outgoing-category}	321
show ipv6 dhcp6 binding	490
show ipv6 interface {interface_name   all}	115
show ipv6 nd ra status config_interface	115
show ipv6 neighbor-list	572
show ipv6 static address interface	115
show ipv6 status	509
show isakmp keepalive	271
show isakmp policy [policy_name]	271
show isakmp sa	281
show l2-isolation	213
show l2-isolation activation	213
show l2-isolation white-list [rule_number]	213
show l2-isolation white-list activation	213
show l2tp-over-ipsec	295
show l2tp-over-ipsec session	295
show lag available slaves	152
show language {setting   all}	509
show lan-provision ap ap_mac interface {lan_port   vlan_interface   all   ethernet   uplink   vlan}	59
show ldap-server	459
show led status	46
show led_locator ap_mac_address status	110

---

show led_suppress ap_mac_address status .....	109
show lockout-users .....	437
show logging debug entries [priority pri] [category module_name] [srcip ip] [srcip6 ipv6_addr] [dstip ip] [dstip6 ipv6_addr] [service service_name] [srciface interface_name] [dstiface interface_name] [protocol protocol] [begin <1..512> end <1..512>] [keyword keyword] 550	
show logging debug entries field field [begin <1..1024> end <1..1024>] .....	551
show logging debug status .....	550
show logging entries [priority pri] [category module_name] [srcip ip] [srcip6 ipv6_addr] [dstip ip] [dstip6 ipv6_addr] [service service_name] [begin <1..512> end <1..512>] [keyword keyword] [srciface interface_name] [dstiface interface_name] [protocol protocol] 549	
show logging entries field field [begin <1..512> end <1..512>] .....	549
show logging status console .....	553
show logging status mail .....	552
show logging status syslog .....	551
show logging status system-log .....	549
show logging status usb-storage .....	146
show login-page default-title .....	498
show login-page settings .....	498
show logo settings .....	498
show mac .....	46
show mem status .....	46
show mem status all .....	561
show mem-conserve status .....	584
show myzyxel-service get-cloud-timezone .....	499
show ntp server .....	500
show object-group {address   address6} [group_name] .....	449
show object-group application <object> .....	442
show object-group service group_name .....	455
show ospf area IP virtual-link .....	174
show packet-capture config .....	572
show packet-capture status .....	572
show page-customization .....	498
show password complexity-verify status .....	434
show payment-service account-delivery .....	259
show payment-service activation .....	260
show payment-service check payment-all-currency .....	260
show payment-service fail-page settings .....	260
show payment-service mobile-fail-page settings .....	260
show payment-service mobile-page-customization .....	260
show payment-service mobile-profile-page settings .....	260
show payment-service mobile-sms-page settings .....	260
show payment-service mobile-success-page settings .....	260
show payment-service page-customization .....	260
show payment-service profile-page settings .....	260
show payment-service provider paypal .....	260
show payment-service provider select .....	260
show payment-service sms-page settings .....	260
show payment-service success-page settings .....	260
show ping-check [interface_name   status] .....	132
show policy-route [policy_number] .....	167
show policy-route begin <1..200> end <1..200> .....	167
show policy-route conn-check .....	167
show policy-route conn-check [policy_number] .....	167
show policy-route conn-check status [policy_number] .....	167
show policy-route controll-ipsec-dynamic-rules .....	167
show policy-route controll-virtual-server-rules .....	167
show policy-route override-direct-route .....	167
show policy-route rule_count .....	168

show policy-route underlayer-rules	168
show policy-route6 [policy_number]	168
show policy-route6 begin <1..200> end <1..200>	168
show policy-route6 controll-ipsec-dynamic-rules	168
show policy-route6 override-direct-route	168
show policy-route6 rule_count	168
show port setting	134
show port statistic portx interval <5..3600>	134
show port status	134
show port type physical	134
show port vlan-id	149
show port-grouping	134
show printer-manager button	262
show printer-manager discover-printer-status	262
show printer-manager printer [<1..10>]	262
show printer-manager printerfw version	262
show printer-manager printer-status	262
show printer-manager printout-type	262
show printer-manager settings	262
show printer-manager workableIP	262
show pwd-expiry {all   expiration   force-to-change-pwd   link-to-device}	434
show radius-server	460
show ram-size	46
show redirect-service <1..20>	202
show reference object aaa authentication [default   auth_method]	44
show reference object account pppoe [object_name]	44
show reference object account pptp [object_name]	44
show reference object address [object_name]	44
show reference object address6 [object_name]	44
show reference object app-patrol [profile-name]	44
show reference object ca category {local remote} [cert_name]	44
show reference object crypto map [crypto_name]	44
show reference object device <profile name>	429
show reference object dhcp6-lease-object [object_name]	45
show reference object dhcp6-request-object [object_name]	45
show reference object interface [interface_name   virtual_interface_name]	44
show reference object isakmp policy [isakmp_name]	45
show reference object schedule [object_name]	44
show reference object service [object_name]	44
show reference object sslvpn application [object_name]	44
show reference object sslvpn policy [object_name]	45
show reference object username [username]	44
show reference object zone [object_name]	45
show reference object-group aaa ad [group_name]	45
show reference object-group aaa ldap [group_name]	45
show reference object-group aaa radius [group_name]	45
show reference object-group address [object_name]	45
show reference object-group address6 [object_name]	45
show reference object-group interface [object_name]	45
show reference object-group service [object_name]	45
show reference object-group username [username]	45
show remote-assistance	563
show remote-assistance generate	563
show report [interface_name {ip   service   url}]	555
show report [interface_name] https-url	556
show report packet size statistics {interface_name} [interval interval]	557
show report packet size statistics status	557
show report status	555
show respmsg url-filter block-page	508



show rip {global   interface {all   <i>interface_name</i> }}	130
show rogue-ap containment config	98
show rogue-ap containment list	98
show rogue-ap detection info	96
show rogue-ap detection list {rogue   friendly  all}	96
show rogue-ap detection monitoring	96
show rogue-ap detection status	96
show route order	565
show rtls ekahau cli	318
show rtls ekahau config	318
show running-config	529
show sa counter	281
show sa monitor [{begin <1..1000>}   {end <1..1000>}   {crypto-map regexp}   {policy regexp}   {rsort <i>sort_order</i> }   {sort <i>sort_order</i> }]	281
show sa monitor [ap-description <i>desc</i> ] rap	64
show sandbox dashboard statistics summary	50
show sandbox file-type all	337
show sandbox file-type status	337
show sandbox statistics collect	337
show sandbox statistics dashboard summary	337
show sandbox statistics ranking file-name	337
show sandbox statistics summary	337
show sandbox status	337
show schedule reboot status	578
show schedule-object	456
show sdwan oncloudst	580
show secure-policy	218
show secure-policy any ZyWALL	218
show secure-policy backup status	216
show secure-policy block_rules	218
show secure-policy _check-exposed-srv	216
show secure-policy filter from <i>zone_object</i> to <i>zone_object</i> srcip <ip-address> dstip <ip> service {any   tcp   udp   icmp   gre   esp   user-defined} port-number user <i>user_name</i> sch <i>schedule_object</i>	217
show secure-policy <i>rule_number</i>	218
show secure-policy status	218
show secure-policy <i>zone_object</i> { <i>zone_object</i>  ZyWALL}	218
show secure-policy <i>zone_object</i> { <i>zone_object</i>  ZyWALL} <i>rule_number</i>	218
show secure-policy6	219
show secure-policy6 any ZyWALL	219
show secure-policy6 block_rules	219
show secure-policy6 filter from <i>zone_object</i> to <i>zone_object</i> srcip6 <ip-address> dstip6 <ip> service {any   tcp   udp   icmp   gre   esp   user-defined} port-number user <i>user_name</i> sch <i>schedule_object</i>	218
show secure-policy6 <i>rule_number</i>	219
show secure-policy6 status	219
show secure-policy6 <i>zone_object</i> { <i>zone_object</i>  ZyWALL}	219
show secure-policy6 <i>zone_object</i> { <i>zone_object</i>  ZyWALL} <i>rule_number</i>	219
show secure-policy-style status	222
show secu-reporter category status	242
show secu-reporter status	241
show security-service inspect status	222
show security-service ip6-exception	416
show security-service ip-exception	416
show security-service signature status	307
show security-service signature status	315
show security-service signature status	329
show security-service status	307
show security-service status	311

show security-service status .....	320
show security-service status .....	325
show security-service status .....	335
show security-service status .....	337
show security-service status .....	340
show security-service status .....	394
show security-service status .....	50
show serial-number .....	46
show service-object [object_name] .....	453
show service-register content-filter-engine .....	53
show service-register status {all   application-security   as   av   cdr   concurrent-device- upgrade   content-filter   firmware-upgrade   geo-ip   idp   malware-blocker   ctdb   managed-ap-service   pkg   reputation-filter   sandbox   secu-reporter   secure-wifi   sslvpn   sslvpn-status   web-security   zymesh} .....	53
show service-register status content-filter {commtouch} .....	53
show service-register status secu-reporter .....	241
show service-register status sslvpn-status .....	53
show session-timeout {icmp   tcp-timewait   udp} .....	564
show session-limit .....	227
show session-limit begin rule_number end rule_number .....	227
show session-limit rule_number .....	227
show session-limit status .....	227
show session-limit6 .....	228
show session-limit6 begin rule_number end rule_number .....	228
show session-limit6 rule_number .....	228
show session-limit6 status .....	228
show session-status-update reply-time .....	219
show setenv-startup .....	529
show sms-service .....	507
show sms-service activation .....	507
show sms-service default-country-code .....	507
show sms-service provider email-to-sms .....	507
show sms-service provider vianett .....	507
show snmp status .....	522
show snmp-server v3user status .....	522
show socket listen .....	46
show socket open .....	46
show software-watchdog-timer log .....	581
show software-watchdog-timer status .....	581
show ssl-inspection cert-list .....	412
show ssl-inspection cert-update status .....	412
show ssl-inspection default-cert update .....	412
show ssl-inspection default-cert version .....	412
show ssl-inspection exclude-list .....	410
show ssl-inspection exclude-list settings .....	410
show ssl-inspection profile [SSI_profile_name] .....	412
show ssl-inspection statistics collect .....	413
show ssl-inspection statistics summary .....	413
show ssl-inspection status .....	409
show sslvpn application [application_object] .....	487
show sslvpn login-port .....	288
show sslvpn monitor .....	288
show ssl-vpn network-extension local-ip .....	288
show sslvpn policy [profile_name] .....	288
show sso {agent   port   presharekey} .....	249
show sso agent .....	251
show sso agent primary .....	251
show sso agent secondary .....	251
show sso agent status .....	251

show sso port	251
show sso presharekey	251
show sta-info {mac_address   all} usage timer	47
show sta-info top 10 alert {2.4G   5G   all}	99
show sta-info top number usage timer	47
show sta-info total usage timer	47
show storm-control ethernet ap mac_address	82
show system default-interface-group	160
show system default-snat	160
show system route default-wan-trunk	565
show system route dynamic-vpn	565
show system route nat-1-1	565
show system route policy-route	565
show system route site-to-site-vpn	565
show system snat default-snat	565
show system snat nat-1-1	565
show system snat nat-loopback	565
show system snat order	565
show system snat policy-route	565
show system uptime	46
show threat-website {trust forbid}	325
show threat-website ebl	328
show threat-website ebl <1..4> {date   number}	328
show threat-website ebl <profile name>	328
show threat-website ebl signature update	328
show threat-website search {ipv6address   ipv4address}	328
show threat-website statistics collect	331
show threat-website statistics list	331
show threat-website statistics summary	331
show threat-website status	325
show two-factor-auth	472
show two-factor-auth admin-access	474
show two-factor-auth admin-access	474
show usb-storage	145
show usb-storage space	147
show usb-storage space ftp	147
show usb-storage space tmp	147
show usb-storage space usb	147
show usb-storage update-firmware status	147
show username [username]	432
show username username google-auth backup-code	474
show username username google-auth qrcode	474
show users {username   all   current}	437
show users default-setting {all   user-type {admin user guest limited-admin ext-user  ext-group-user}}	434
show users idle-detection-settings	435
show users retry-settings	435
show users simultaneous-logon-settings	435
show users update-lease-settings	435
show version	46
show vpn-concentrator [profile_name]	279
show vpn-concentrator6 [profile_name]	286
show vpn-configuration-provision activation	280
show vpn-configuration-provision authentication	280
show vpn-configuration-provision iosfilter	280
show vpn-configuration-provision port	280
show vpn-configuration-provision rules	280
show vpn-counters	281
show vpn-interface-restriction status	157

show vpn-policy-pool .....	64
show vrpt send device information interval .....	551
show vrpt send interface statistics interval .....	551
show vrpt send system status interval .....	552
show walled-garden activation .....	266
show walled-garden rule <1..50> .....	266
show web-auth activation .....	246
show web-auth default-rule .....	246
show web-auth exceptional-service .....	246
show web-auth method .....	246
show web-auth policy {<1..1024>   all} .....	246
show web-auth portal status .....	247
show web-auth redirect-fqdn .....	246
show web-auth redirect-parameter .....	246
show web-auth status .....	247
show wireless-health-action .....	99
show wlan-macfilter-profile {all   macfilter_profile_name} .....	92
show wlan-monitor-profile {all   monitor_profile_name} .....	82
show wlan-radio-profile {all   radio_profile_name} .....	75
show wlan-security-profile {all   security_profile_name} .....	87
show wlan-ssid-profile {all   ssid_profile_name} .....	84
show workspace application .....	289
show workspace cifs .....	289
show zon lldp neighbors .....	510
show zon lldp server config .....	510
show zon lldp server statistics .....	510
show zon lldp server status .....	510
show zon zdp server status .....	510
show zone [profile_name] .....	180
show zone binding-iface .....	180
show zone default-binding .....	180
show zone none-binding .....	180
show zone system-default .....	180
show zone user-define .....	180
show zymesh ap info .....	93
show zymesh link info {repeater-ap   root-ap} .....	93
show zymesh provision-group .....	94
show zymesh-profile {all   zymesh_profile_name} .....	94
show vcp allowed crypto map .....	280
show vcp allowed crypto map6 .....	280
show vcp allowed users .....	280
shutdown .....	42
signature sid action {drop   reject-sender   reject-receiver   reject-both} .....	343
signature sid action {drop   reject-sender   reject-receiver   reject-both} .....	344
signature sid block_period .....	344
signature sid counts .....	344
signature sid log [alert] .....	343
signature sid seconds .....	344
sms-service account-send phone phone_number account user_name password password ..	506
sms-service default-country-code country_code .....	506
sms-service provider email-to-sms .....	507
sms-service provider vianett .....	506
sms-service provider-select vianett {vianett email-to-sms} .....	506
sms-service test-send phone phone_number msg message .....	507
sms-service _two-factor-auth-admin-send phone phone user username verification-code verifica- tion_code .....	433
smtp helo-name name .....	196
smtp-address {ip   hostname} .....	557
smtp-auth username username password password .....	557

snaplen <68..1512> .....	570
snmp-server rule {rule_number append insert rule_number} access-group {ALL address_object} zone {ALL zone_object} action {accept deny} .....	521
snmp-server rule move rule_number to rule_number .....	522
snmp-server v3user username description authentication {md5   sha} privacy {none   des   aes} privilege {ro   rw} .....	522
snmp-server version {v2c   v3} .....	522
source {src-ipv4-obj   any} destination {dst-ipv4-obj   any} service {service_obj   any} .....	233
source <url> .....	323
source <url> .....	328
split-size <1..2048> .....	570
src-ip {add del}{ipv4_address / local} .....	104
ssh {user@W.X.Y.Z   or W.X.Y.Z} .....	516
ssid ssid .....	94
ssl-inspection cache flush .....	412
ssl-inspection cert-update now .....	412
ssl-inspection exclude-list .....	410
ssl-inspection exclude-list-settings .....	410
ssl-inspection pkt-enc-mss <536..1460> .....	409
ssl-inspection profile rename SSI_profile_name1 SSI_profile_name2 .....	411
ssl-inspection profile ssi_profile_name .....	410
ssl-inspection server-sign-cert mode {default   rsa-1024   rsa-2048} .....	409
ssl-inspection server-sign-cert mode {ecdsa-rsa-1024 ecdsa-rsa-2048} .....	409
ssl-inspection statistics flush .....	413
ssl-inspection tls1-2 aesgcm {activate   deactivate} .....	412
ssl-inspection tls1-3 {activate   deactivate} .....	412
sslvpn action {pass   block}{no log   log [alert]} .....	411
sslvpn login message <description> .....	288
sslvpn login-domain-1 <domain name> .....	288
sslvpn login-domain-2 <domain name> .....	288
sslvpn login-port <1..65535> .....	288
sslvpn logout message <description> .....	288
sslvpn logout-defer-time <2..10> .....	288
sslvpn network-extension local-ip ip .....	288
sslvpn no connection username user_name .....	289
sslvpn policy {profile_name   profile_name append   profile_name insert <1..16>} .....	288
sslvpn policy move <1..16> to <1..16> .....	289
sslvpn policy rename profile_name profile_name .....	289
sslvpn update-interval <1..300> .....	289
sso agent primary .....	251
sso agent secondary .....	251
sso encrypted-presharekey <ciphertext> .....	251
sso presharekey <preshared key> .....	251
sso_port <1025..65535> .....	251
status .....	58
status: active .....	510
status-code {int/range} .....	196
storage <internal usbstorage> .....	570
storm-control ethernet ap mac_address .....	81
storm-control wireless ap mac_address .....	82
subframe-ampdu <2..64> .....	76
subframe-ampdu <2..64> .....	80
support-version-max {ssl3   tls1_0   tls1_1   tls1_2   tls1_3} .....	411
support-version-min {ssl3   tls1_0   tls1_1   tls1_2   tls1_3} .....	411
sysname system_name .....	66
system default-interface-group group-name .....	160
tcp-decoder {tcp-xxx} log [alert] .....	231
telnet .....	42
test aaa .....	42

test aaa {server secure-server} {ad ldap} host {hostname ipv4-address} [host {hostname ipv4-address}] port <1..65535> base-dn base-dn-string [bind-dn bind-dn-string password password] login-name-attribute attribute [alternative-login-name-attribute attribute] account account-name .....	466
The conf-backup commands automatically backup the current Zyxel Device configuration file according to a schedule, and then send it to an email address. ....	579
The conf-mail commands send a user-specified configuration file immediately to an email address. ....	578
threat-website {trust   forbid} .....	325
threat-website dashboard statistics flush .....	50
threat-website ebl <profile name> .....	327
threat-website ebl rename old_profile_name new_profile_name .....	328
threat-website ebl update .....	328
threat-website ebl update daily <0..23> .....	328
threat-website ebl update hourly .....	328
threat-website ebl update weekly {sun  mon tue wed thu fri sat} <0..23> .....	328
threat-website profile <profile name> action {block   pass   warn} .....	326
threat-website profile profile_name .....	326
threat-website rename old_profile_name new_profile_name .....	326
threat-website statistics flush .....	330
time-period {day <1..365>   hour <1..24>   minute <30..60>} .....	256
time-period <1..432000> .....	495
tracpath6 {ipv6   hostname} .....	572
traceroute .....	42
traceroute {ip   hostname} .....	569
traceroute {ipv4   hostname} [source ipv4] [interface interface_name] [extension filter-extension] .....	571
traceroute6 .....	42
traceroute6 {ipv6   hostname} .....	569
traceroute6 {ipv6   hostname} [source ipv6] [interface interface_name] [extension filter-extension] .....	572
traffic-prioritize {tcp-ack content-filter dns} bandwidth <0..1048576> priority <1..7> [maximize-bandwidth-usage]; .....	144
traffic-prioritize {tcp-ack content-filter dns} bandwidth <0..1048576>; .....	151
traffic-prioritize {tcp-ack content-filter dns} priority-code <0..7> deactivate ..	144
traffic-prioritize {tcp-ack content-filter dns} priority-code <0..7> deactivate ..	151
traffic-prioritize {tcp-ack content-filter dns ipsec-vpn ssl-vpn} bandwidth <0..1048576> priority <1..7> [maximize-bandwidth-usage]; .....	117
traffic-prioritize {tcp-ack content-filter dns ipsec-vpn ssl-vpn} deactivate ....	117
transform-set crypto_algo_ah [crypto_algo_ah [crypto_algo_ah]] .....	274
transform-set crypto_algo_ah [crypto_algo_ah [crypto_algo_ah]] .....	285
transform-set crypto_algo_esp [crypto_algo_esp [crypto_algo_esp]] .....	274
transform-set crypto_algo_esp [crypto_algo_esp [crypto_algo_esp]] .....	285
transform-set isakmp-algo [isakmp_algo] .....	282
transform-set isakmp-algo [isakmp_algo] .....	283
transform-set isakmp-algo [isakmp_algo [isakmp_algo]] .....	272
tunnel destination ipv4 .....	143
tunnel mode [ipv6ip [manual   6to4]] .....	144
tunnel mode ip gre .....	143
tunnel source [ipv4  tunnel_bind_interface _any] .....	143
two-factor-auth admin-access auth-method {google-auth pin-code} .....	473
two-factor-auth allow-access-url-thru-tunnel [activate   deactivate] .....	472
two-factor-auth http port <1...65535> .....	472
two-factor-auth message {message_quoted   message} .....	471
two-factor-auth message-type {default   file} .....	471
two-factor-auth server interface interface_name .....	471
two-factor-auth server user-defined {ipv4 domain_name} .....	471
two-factor-auth sms message {message_quoted   message} .....	471
_two-factor-auth-send email email user username verification-code verification_code	433

tx-mask <i>chain_mask</i> .....	81
type {external   general   internal} .....	152
type {external   internal} .....	247
type {internal   external   general} .....	134
udp-decoder {bad-udp-l4-size   udp-land   udp-smurf} action {drop   reject-sender   reject-receiver   reject-both}	
231	
udp-decoder {bad-udp-l4-size   udp-land   udp-smurf} log [alert] .....	231
unlock lockout-users {ip   console   ipv6_addr} .....	437
unsupported-suite action {pass   block} {no log   log [alert]} .....	411
untrusted-cert-chain action {block   inspect   pass} {no log   log [alert]} .....	411
updelay <0..1000> .....	152
url [timeout <i>query_timeout</i> ] .....	361
url match < <i>string</i> > .....	366
url not-match < <i>string</i> > .....	366
url parameter < <i>string</i> > .....	366
url value < <i>string</i> > .....	366
usb-storage mount .....	145
usb-storage amount .....	145
usb-storage warn <10..99> percentage .....	147
usb-storage warn <100..9999> megabyte .....	147
usb-storage warn <i>number</i> <percentage   megabyte> .....	145
use-defined-mac .....	134
user <i>isp_account_username</i> .....	295
user <i>username</i> .....	279
USER_NAME_ .....	552
username rename <i>username username</i> .....	432
username <i>username</i> [no] {email1-verify email2-verify} .....	433
username <i>username</i> [no] {email1-verify email2-verify} .....	474
username <i>username</i> [no] description <i>description</i> .....	432
username <i>username</i> [no] email <1..2> <i>email-address</i> .....	433
username <i>username</i> [no] google-auth .....	474
username <i>username</i> [no] logon-lease-time <0..1440> .....	433
username <i>username</i> [no] logon-re-auth-time <0..1440> .....	433
username <i>username</i> [no] phone <i>phone_number</i> .....	433
username <i>username</i> [no] phone-verify .....	433
username <i>username</i> [no] phone-verify .....	474
username <i>username</i> 2fa-auth-method {default google-auth pin-code} .....	474
username <i>username</i> encrypted-password < <i>password</i> > .....	432
username <i>username</i> google-auth backup-code create .....	474
username <i>username</i> google-auth verify-code <verification code> .....	474
username <i>username</i> logon-time-setting <default   manual> .....	433
username <i>username</i> nopassword user-type {admin   guest   limited-admin   user} ...	432
username <i>username</i> password <i>password</i> user-type {admin   guest   limited-admin   user} 432	
username <i>username</i> user-type ext-group-user associated-aaa-server <i>server_profile</i> group-id <i>id</i>	
432	
username <i>username</i> user-type ext-user .....	432
username <i>username</i> user-type mac-address .....	432
username <i>username</i> vlan activate .....	433
username <i>username</i> vlan id <1..4094> .....	433
users default-setting [no] logon-lease-time <0..1440> .....	434
users default-setting [no] logon-re-auth-time <0..1440> .....	435
users default-setting [no] user-type <admin   ext-user   guest   limited-admin   user   ext-group-user>	
.....	435
users default-setting [no] user-type <admin   ext-user   guest   limited-admin   user   ext-group-user>	
logon-lease-time <0..1440> .....	435
users default-setting [no] user-type <admin   ext-user   guest   limited-admin   user   ext-group-user>	
logon-re-auth-time <0..1440> .....	435
users force-logout { <i>username</i>   ip   ipv6_addr} .....	437
virtual-service interface <i>interface_name</i> external-ip { <i>address/object</i> } external-port <i>port</i> protocol { <i>tcp/udp</i> } 194	

virtual-service interface <i>interface_name</i> external-ip { <i>address/object</i> } external-service <i>service</i> ..	194
vlan <1..4094> {tag   untag} .....	70
vlan_interface {activate   inactivate} vid <1..4094> join <i>lan_port</i> {tag   untag} [ <i>lan_port</i> {tag   untag}]	
[ <i>lan_port</i> {tag   untag}] .....	58
vlan-priority-code <0..7> .....	303
vpn-concentrator rename <i>profile_name profile_name</i> .....	279
vpn-concentrator6 rename <i>profile_name profile_name</i> .....	286
vpn-configuration-provision authentication <i>auth_method</i> .....	280
vpn-configuration-provision port <1...65535> .....	280
vpn-configuration-provision rule { append   <i>conf_index</i>   insert <i>conf_index</i> } ....	279
vpn-configuration-provision rule { delete <i>conf_index</i>   move <i>conf_index</i> to <i>conf_index</i> } .....	279
vpn-interface-restriction activate .....	156
vpn-interface-restriction deactivate .....	157
vpn-policy-pool start <i>start_ip</i> end <i>end_ip</i> .....	64
vrpt send device information interval <15..3600> .....	551
vrpt send interface statistics interval <15..3600> .....	551
vrpt send system status interval <15..3600> .....	551
wac6553d-e} <i>ap_lan_port</i> activate pvid <1..4094> .....	69
wac6553d-e} <i>ap_lan_port</i> inactivate pvid <1..4094> .....	69
wac6553d-e} vlan_interface activate vid <1..4094> join <i>ap_lan_port</i> {tag   untag} [ <i>ap_lan_port</i> {tag   untag}]	
[ <i>ap_lan_port</i> {tag   untag}] .....	69
wac6553d-e} vlan_interface inactivate vid <1..4094> join <i>ap_lan_port</i> {tag   untag} [ <i>ap_lan_port</i> {tag   untag}]	
[ <i>ap_lan_port</i> {tag   untag}] .....	69
walled-garden domain-ip rule <1..50> .....	266
walled-garden domain-ip rule append .....	266
walled-garden domain-ip rule flush .....	266
walled-garden rule append .....	265
walled-garden rule flush .....	266
walled-garden rule insert <1..50> .....	266
walled-garden rule move <1..50> to <1..50> .....	266
web-auth [no] exceptional-service <i>service_name</i> .....	245
web-auth default-rule authentication {required   unnecessary} {no log   log [alert]} .....	245
web-auth google-auth valid-time <1..5> .....	245
web-auth login setting .....	245
web-auth method portal .....	245
web-auth policy <1..1024> .....	245
web-auth policy append .....	245
web-auth policy delete <1..1024> .....	245
web-auth policy flush .....	245
web-auth policy insert <1..1024> .....	245
web-auth policy move <1..1024> to <1..1024> .....	245
web-auth redirect-parameter .....	246
web-auth web-portal .....	246
WEEKDAYS .....	552
white-list activate .....	213
white-list append .....	213
white-list flush .....	213
white-list no activate .....	213
white-list <i>rule_number</i> .....	213
wireless-health monitor act-lock-time .....	81
wireless-health monitor inactivate .....	81
wireless-health monitor interval .....	81
wireless-health monitor issue-list .....	81
wireless-health radio {action   act-lock-time <1...1440>   recovery-threshold <10...1000>  act-	
threshold <10...1000>  data-collect-interval <0...120>} .....	101
wireless-health radio action {dcs_now   downgrade_cw   none} .....	102
wireless-health sta {action   act-lock-time <1...1440>  act-threshold <10...1000>  data-col-	
lect-interval <0...120>} .....	101
wireless-health sta action {kick_sta   none} .....	102



---

wlan-macfilter-profile rename <i>macfilter_profile_name1 macfilter_profile_name2</i>	92
wlan-monitor-profile rename <i>monitor_profile_name1 monitor_profile_name2</i>	82
wlan-radio-profile rename <i>radio_profile_name1 radio_profile_name2</i>	75
wlan-security-profile rename <i>security_profile_name1 security_profile_name2</i>	87
wlan-ssid-profile rename <i>ssid_profile_name1 ssid_profile_name2</i>	84
write	42
write	529
xauth type {server <i>auth_method</i> [user-id { <i>username</i>   any}]   client name <i>username</i> password <i>password</i> } [deactivate]	273
xmit-hash-policy { <i>layer2</i>   <i>layer2_3</i> }	152
zon lldp server	510
zon lldp server tx-hold <1..10>	510
zon lldp server tx-interval <1..600>	510
zon zdp server	510
zone <i>profile_name</i>	180
ZYLOG_SUBJECT	552
zymesh provision-group <i>ac_mac</i>	94
zymesh-profile rename <i>zymesh_profile_name1 zymesh_profile_name2</i>	94